

**IN-092**

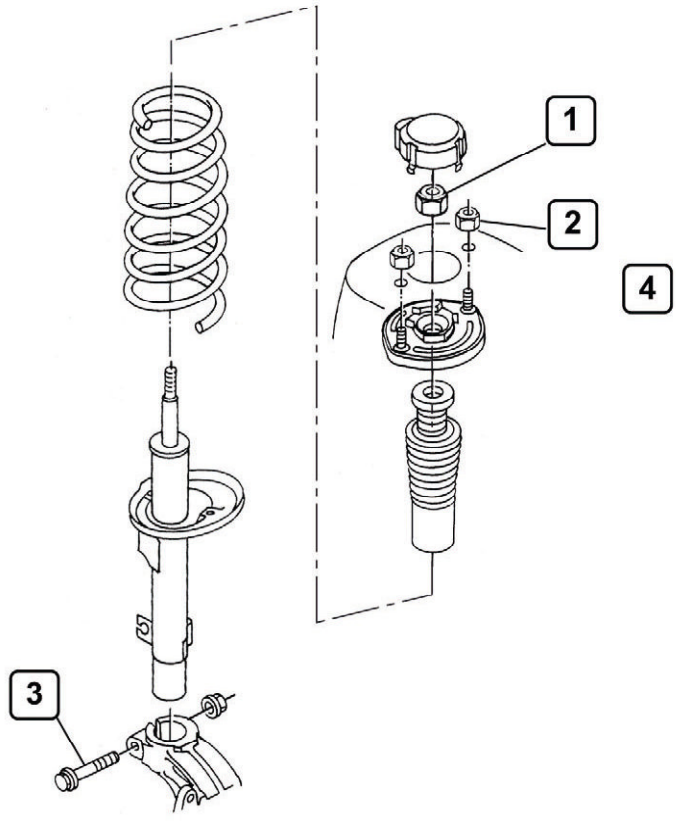

- 1 70 Nm
- 2 40 Nm
- 3 60 Nm
- 4 60 Nm



O.E  
KYB

