

ORIS^{ACPS}

ORIS Tracc



FIX4BIKE
System



ONLY USE WITH
FIX4BIKE



ORIS Tracc FIX4BIKE
no.: 710-002



Standard
System

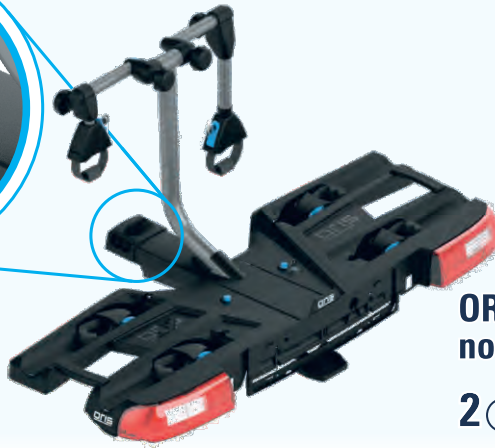

ORIS Tracc
no.: 700-002



Extension kit 3rd bike
no. 790-009



Bedienungsanleitung
Operating manual
Kezelési útmutató
Mode d'emploi

Instruções de uso
Gebruiksaanwijzing
Руководство по эксплуатации
Instrucțiuni de folosire
Istruzioni per l'uso

Betjeningsvejledning
Bruksanvisning
Bruksanvisning
Návod k obsluze
Instrucciones de manejo

Instrukcja obsługi
Οδηγίες χειρισμού
Käyttöohje
Kullanma Kilavuzu



Contents

4 Technical data



12 Using the number plate

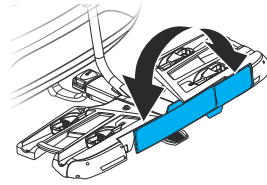

5-7 Safety instructions



13 Using the ratchet strap

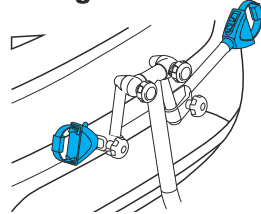

8 Mounting to the ball

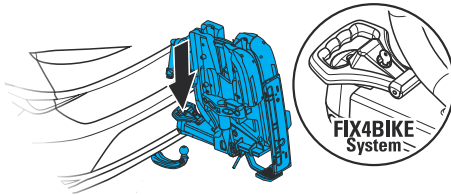

14 Using the wheel holder

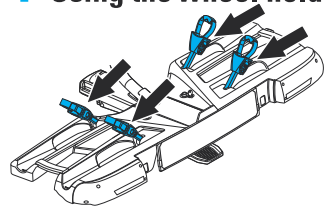

9 Mounting to the ball

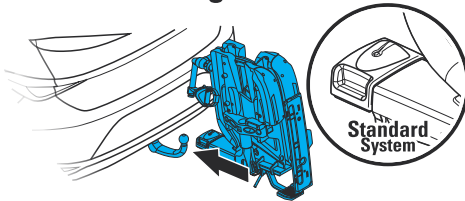

15 Using the bike arms

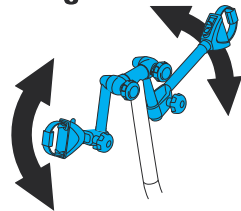

10-11 Mounting to the vehicle

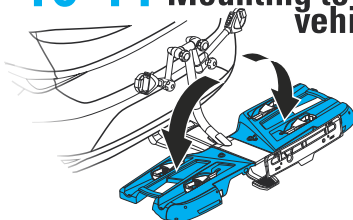

15 Using the bike arms

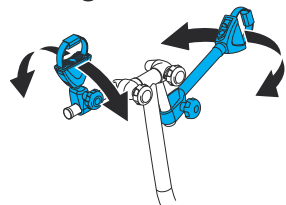



16-17 Mounting the bikes

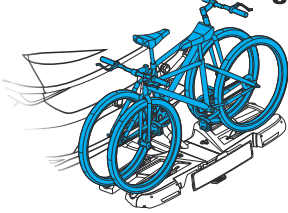

21 Demounting from the Vehicle

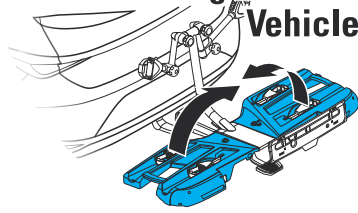

18-19 Mounting the 3rd bike extension

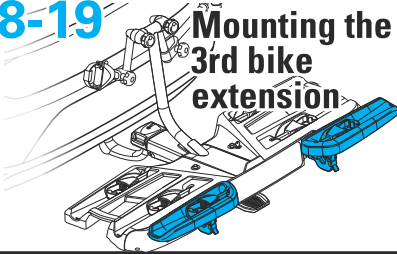

22 Demounting from the ball

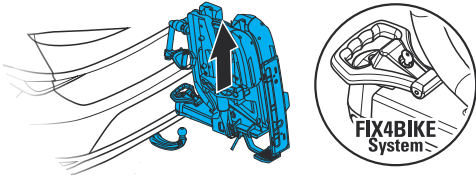

20 Removing the number plate

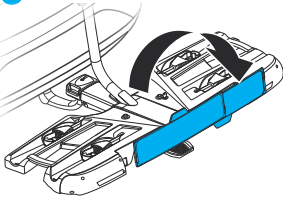

23 Demounting from the ball

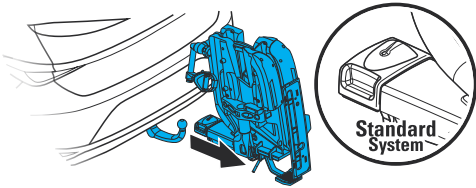



Technical data

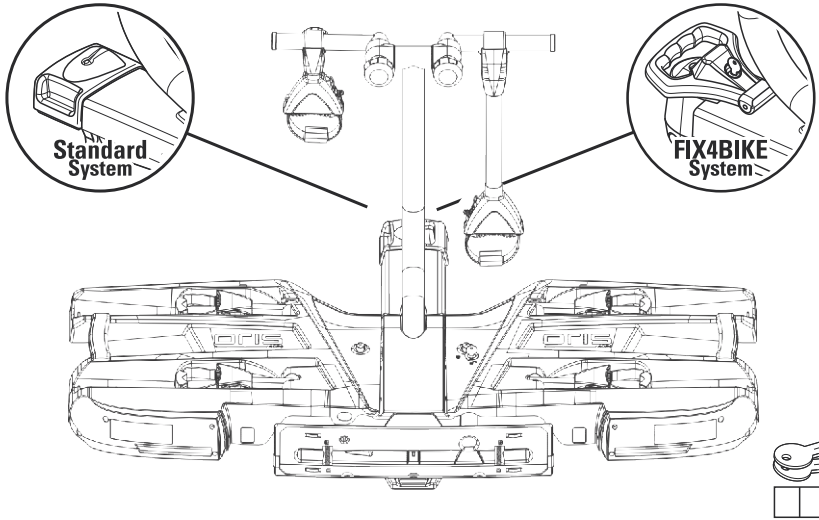

OrisTracc / OrisTracc FIX4BIKE

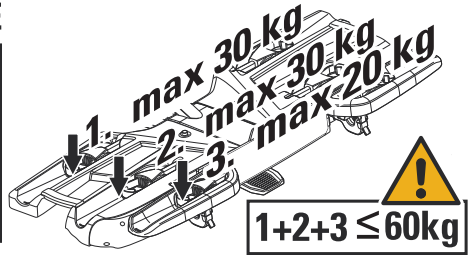
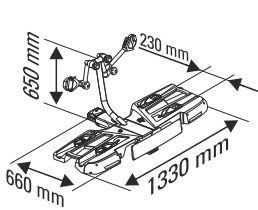

OrisTracc

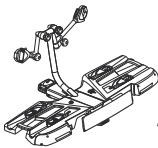

KG 16,9 kg (±3%)



OrisTracc FIX4BIKE

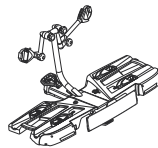

KG 18,4 kg (±3%)



Oris Tracc 3rd Bike Extension

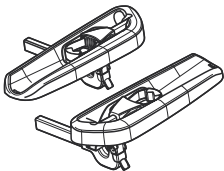

KG 3 kg (±3%)

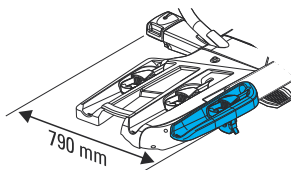

- A (1x)
- B (2x)
- C (2x)
- D (2x)
- E (6x)
- F (2x)
- G (1x)

Allgemeine Information

Das Fahrzeug sollte entsprechend der StVZO vom 01.01.1990 mit einer 13-poligen Steckdose ausgerüstet sein.

Die fahrzeugeigene Nebelschlussleuchte muss bei eingesteckter Beleuchtung des Fahrradträgers über Kontakt oder Relais ausgeschaltet sein.

Am Fahrradträger muss ein, mit dem polizeilichen Kennzeichen des Fahrzeugs übereinstimmendes, ungestempeltes Kennzeichen montiert sein.

Die landesspezifischen Zulassungsbestimmungen und gesetzlichen Vorschriften sind zu beachten.

Der OrisTracc besitzt eine EG-Betriebserlaubnis als selbständige technische Einheit:
Model: OrisTracc
Type: OrisTracc
E9*26R04/001300

Die EG-Betriebserlaubnisnummer ist am Fahrradträger angebracht. Dieses Typenschild genügt als Bestätigung für die Betriebserlaubnis.

Die zulässige Stützlast der Anhängerkupplung darf nicht überschritten werden. Die fahrzeugspezifischen Daten sind zu beachten.

Montage

Sollten sich bei der Montage oder Bedienung Fragen ergeben, wenden Sie sich bitte an unseren Kundenservice. Änderungen von technischen Details gegenüber Abbildungen der Montageanleitung sind vorbehalten.

Der Montageanweisung sowie die darin enthaltenen Sicherheitshinweise sind zu befolgen. Bei Missachtung der Montageanleitung sowie deren Sicherheitshinweisen können Sach- und Personenschäden die Folge sein. In diesem Fall obliegt die Haftung allein dem Nutzer. ACPS Automotive Services GmbH schließt diesbezüglich jegliche Haftung aus.

Zur Montage des Fahrradträgers muss der Kugelkopf fettfrei, metallisch blank, sauber und unbeschädigt sein.

General information

The vehicle should be equipped with a 13-pin socket, according to the German Road Traffic Licensing Regulations as of 1990-01-01.

The vehicle's fog lamp must be switched off via contact or relay when the bike carrier lighting is plugged in.

An unstamped (invalidated) number plate, corresponding to the vehicle's registered number plate, must be mounted on the bicycle carrier.

The country-specific approval regulations and legal requirements must be observed.

The OrisTracc is licensed within the EC as a self-contained technical unit:
Model: OrisTracc
Type: OrisTracc
E9*26R04/001300

The EC type-approval number is imprinted to the type label of the bike carrier. This type label is sufficient as a verification of the type approval.

The permitted bearing load of the trailer hitch must not be exceeded. Additional specific information of the vehicle must be observed.

Mounting

If you have any questions when assembling or handling this product, please contact our customer service. Technical details are subject to change and may differ from figures in the instructions for assembling.

The assembly instructions and the safety instructions contained therein must be followed. Failure to follow the installation instructions and the safety instructions contained therein may result in damage to property and personal injury. In this case, liability lies solely with the user. ACPS Automotive Services GmbH excludes any liability in this regard.

The towball must be clean, metallically bright, undamaged and free from grease for assembling of the bike carrier.



**Safety
instruction**

ORIS
ACPS

5/24



Safety instruction

Vor Fahrtantritt

Vor jeder Fahrt ist die Funktion aller Leuchten und der sichere Halt des Fahrradträgers inklusive der montierten Fahrräder zu überprüfen. Laut StVO ist der Fahrzeugführer bzw. der Fahrzeughalter allein für den Zustand und die sichere Befestigung des Fahrradträgers verantwortlich!

Nach der Erstmontage müssen alle Befestigungselemente des Fahrradträgers nach einer Fahrtstrecke von ca. 15 km auf festen Sitz überprüft und gegebenenfalls nachjustiert werden. Auch alle beweglichen Teile wie Haltearme und Handräder usw. müssen in die Prüfung einbezogen werden. Bei längeren Fahrten oder schlechter Wegstrecke die Prüfung regelmäßig wiederholen.



Für einen sicheren Halt auf der Anhängerkupplung muss der Fahrradträger einmal nachgespannt werden (gilt nur für den Fahrradträger ORISTracc, Art.-Nr. 700-002). Dafür muss das rechte Seitenteil mit mindestens 47 kg bis zum Einrasten nach unten gedrückt werden. Sollten diese Kraft nicht erreicht werden, muss der Vorgang wiederholt werden.

Ein nicht richtig befestigter Fahrradträger kann sich vom Fahrzeug lösen und einen Unfall verursachen.

Der Fahrradträger darf keinesfalls in gefaltetem und/oder verpacktem Zustand auf der Anhängerkupplung transportiert werden. Die Aufbewahrungstasche des Fahrradträgers ist vor Fahrtantritt unbedingt vom Träger zu entfernen.

Auch ohne Ladung müssen vor Fahrtantritt alle Funktionen des Fahrradträgers überprüft werden. Haltearme und Reifenbänder immer feststratschen und abschließen. Der Kofferraumdeckel darf nur geöffnet werden, wenn der Fahrradträger abgeklappt ist. Vorsicht mit elektrischen Heckklappen und elektrischen Cabrioverdecken. Es könnten Personen verletzt werden oder Sachschäden am Fahrzeug und am Fahrradträger entstehen.

Before travelling

Before travelling check the lights if they are fully functioning and if the bike carrier and its cargo are securely fixed. According to the road traffic regulations, only the vehicle owner or the driver is responsible for the condition and the secure fixing of the bicycle carrier!

After the first installation, all fastening elements of the bike carrier must be checked after a test drive of approx. 15 km and be tightened if necessary. All mobile parts such as frame holders and hand wheels etc., must also be included into this inspection. Repeat this test regularly, especially if the road conditions are bad.



For a secure hold on the towbar, the bicycle carrier must be retightened at least once (only applies to the ORISTracc bicycle carrier, art. no. 700-002). To do this, the right side part must be folded down with at least 47 kg until it engages. If this force is not achieved, the procedure must be repeated.

An improperly mounted bicycle carrier can detach and cause an accident.

The bicycle carrier must never be transported on the towbar in a folded and/or packed state. The storage bag of the bicycle carrier must be removed from the carrier before travelling.

Each function of the bike carrier must be checked before travelling even if no bikes are transported. Always tighten and lock the frame holders and the retaining straps of the rails securely. The boot can be opened only when the bike carrier is folded down. Be careful with automatic boot lids and electric convertible roofs. People may be injured or the vehicle and the bike carrier damaged.

Transport von Fahrrädern

Auf keinen Fall darf die Ladung mit einer Folie oder sonstigen Materialien abgedeckt werden, da dadurch das Fahrverhalten stark beeinflusst werden kann.

Beachten Sie, dass alle Schlösser des Fahrradträgers sowie der Haltearme immer abgeschlossen werden müssen.

Beim Transport der Fahrräder müssen alle losen Teile (Luftpumpen, Kindersitze, Fahrradkörbe, Fahrradtaschen, Akkupacks usw.) entfernt werden. Sie könnten sich lösen und Sie oder nachfolgende Verkehrsteilnehmer in Gefahr bringen.

Vorsichtsmaßnahmen während der Fahrt

Beobachten Sie den Fahrradträger während der Fahrt regelmäßig durch den Rückspiegel.

Bei einer erkennbaren Veränderung des Fahrradträgers oder seiner Ladung sofort anhalten, nach der Ursache suchen und die Fahrt erst nach Behebung des Problems fortsetzen.

Bezüglich des OrisTracc und Ladung gelten die Vorschriften der StVO, sowie der StVZO. Die empfohlene Höchstgeschwindigkeit beträgt 130 km/h. Beachten Sie bei Auslandsfahrten die jeweiligen Verkehrsvorschriften.

Verändertes Fahrverhalten

Durch den über das Fahrzeug hinausragenden Fahrradträger kann besonders bei Beladung eine starke Tendenz zum Über- oder Untersteuern, ein verändertes Seitenwindansprechverhalten und ein verändertes Bremsverhalten, besonders bei Kurvenfahrt, auftreten. Passen Sie daher Ihre Geschwindigkeit stets den Straßen, Witterungs- und Windverhältnissen an.

Beachten Sie die veränderte Länge des Fahrzeuges auch beim Parken und Rückwärtsfahren. Beim Befahren von Ab- und Auffahrten und beim Überfahren von Rampen sowie in verkehrsberuhigten Zonen ist auf Freigängigkeit des Fahrradträgers zu achten, um ein Aufsetzen zu vermeiden. In jedem Fall ist die Geschwindigkeit auf ein angemessenes Maß zu reduzieren.

Pflege

Wir empfehlen den Fahrradträger regelmäßig zu reinigen und zu pflegen. Alle beweglichen Teile mit Fahrradöl oder Kettenspray bearbeiten, Lager fetten.

Transport of bicycles

Never cover the load with a foil or other materials, as it can effect the handling of your vehicle.

Ensure that all locks on the bicycle carrier and the frame holders are always locked.

All loose parts (air pumps, water bottles, baskets, child seats etc.) must be removed when transporting the bicycles. They can detach and put you or other road users in danger.

Precautions during travel

Check regularly the bike carrier using the rearview mirror throughout the journey.

Stop immediately if you notice any significant change of the bike carrier or its cargo. Identify the cause and continue your journey after resolving of problem only.

The OrisTracc and its load apply to the provisions of the Road Traffic Regulations. The recommended maximum speed with a loaded bike carrier is 130 km/h. When driving abroad, observe the applicable traffic regulations.

Changed handling of the vehicle

Due to the fact that the bike carrier juts out of the vehicle, there is a great tendency to over- or understeer, a changed reaction to crosswinds and a changed braking function, especially when navigating curves. Always adjust your speed according to the road, weather and wind conditions.

Note the length of the vehicle also when parking or driving in reverse. When driving up or down very steep inclines or when driving over ramps, for instance in traffic calmed areas, the bike carrier must be allowed clearance in order to avoid bumping. In any case, the speed must be reduced to an appropriate level.

Maintenance

It is recommended to clean and maintain the bike carrier regularly. Lubricate all moving parts with bike grease or chain spray, and grease the brackets.



**Safety
instruction**

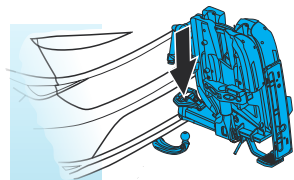

Mounting the FIX4BIKE System

01

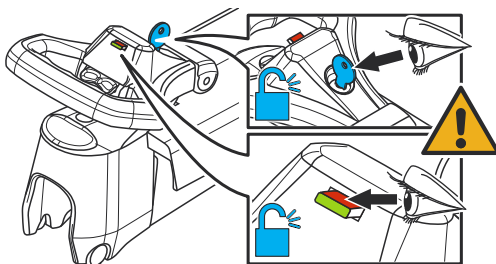

02

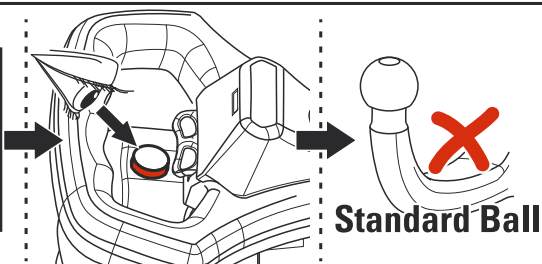
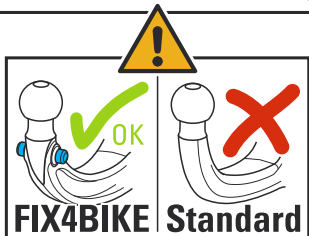

03

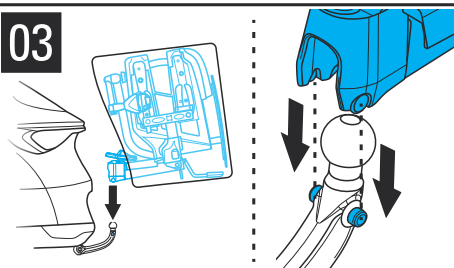

04

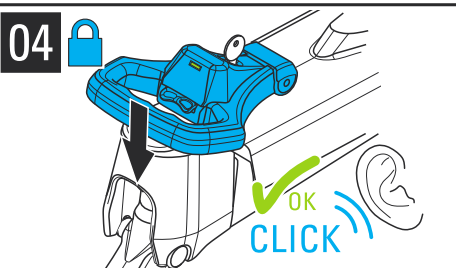

05

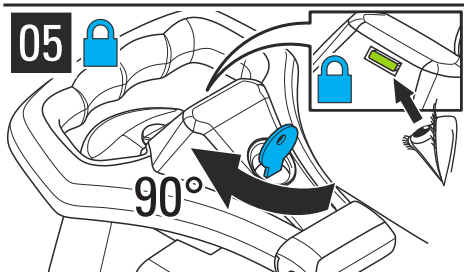

06

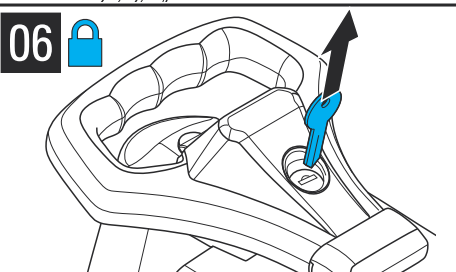

07

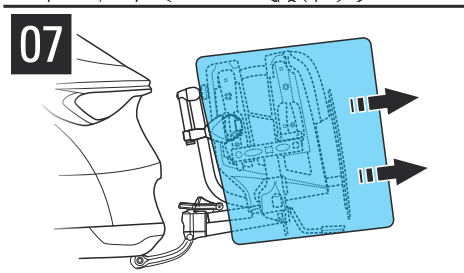

08

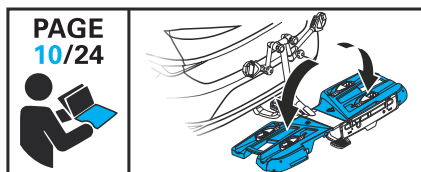

01

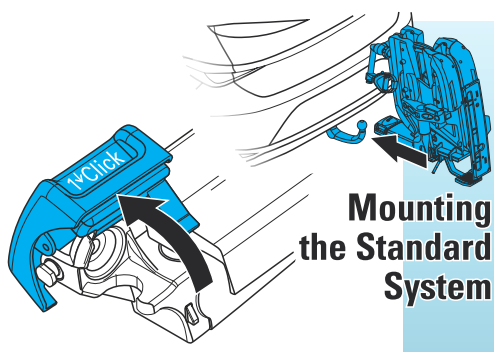
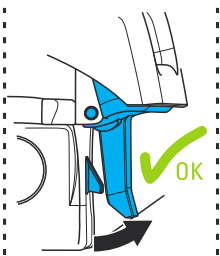
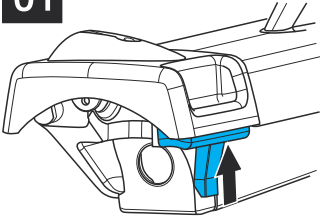

Mounting the Standard System

02

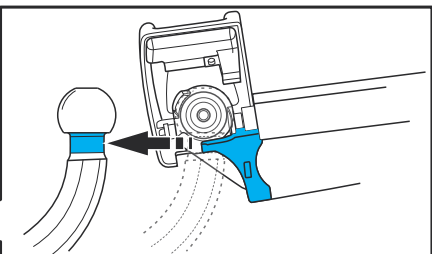
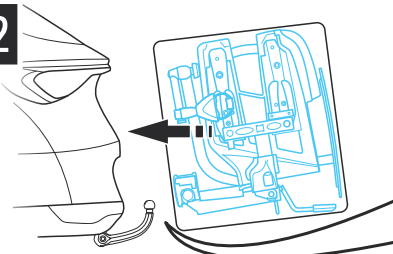

03

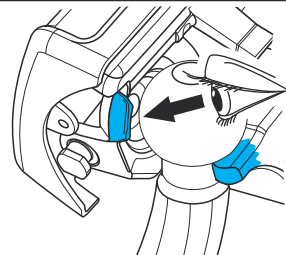
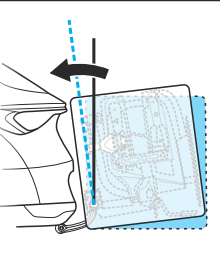
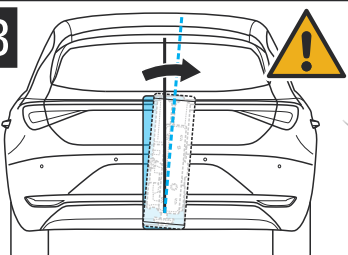

04

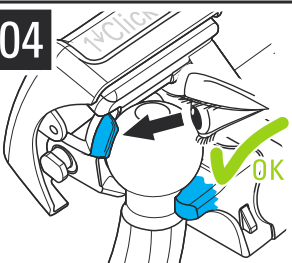

05

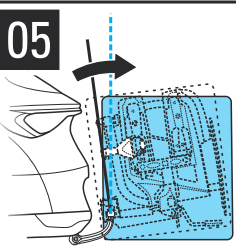

06

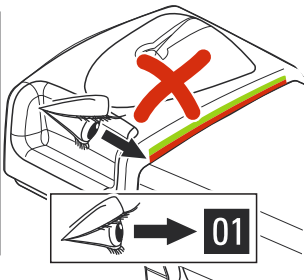
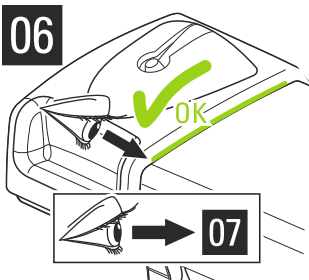

07

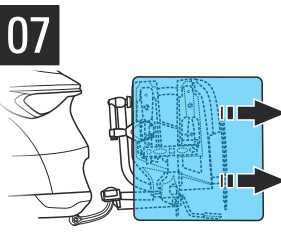

Mounting to the vehicle

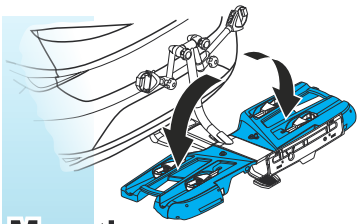

01

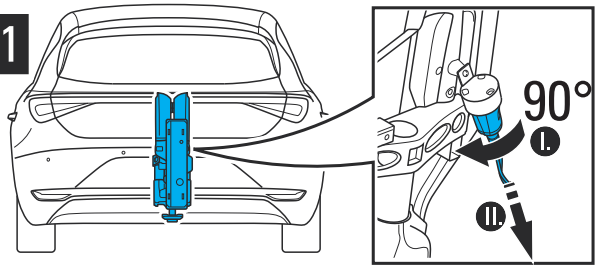

02

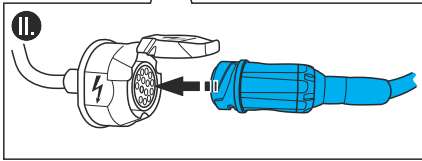
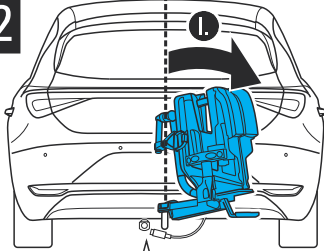

03

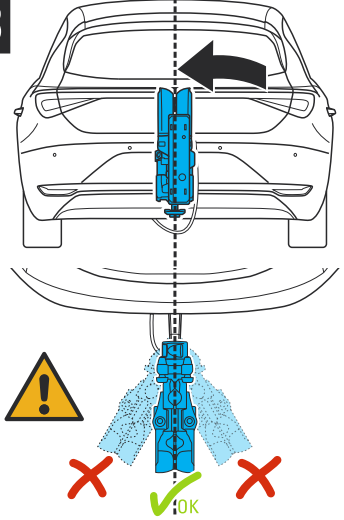

04

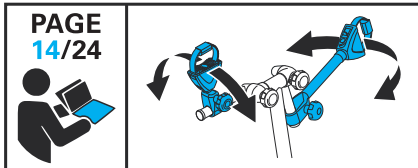
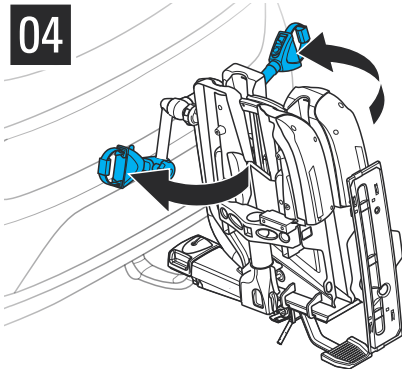

PAGE
14/24



05

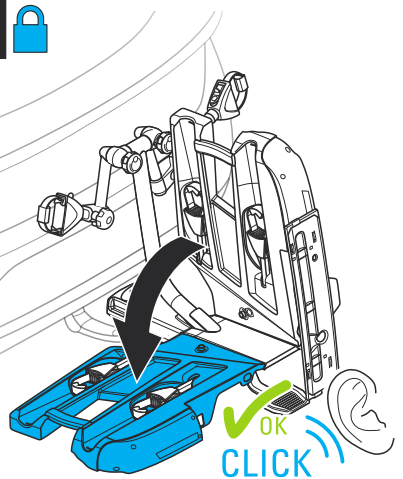

06 

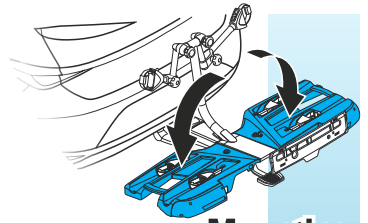
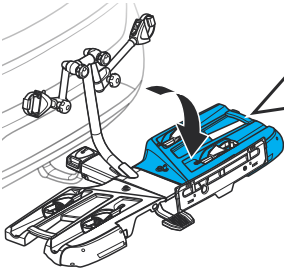





Mounting to the Vehicle

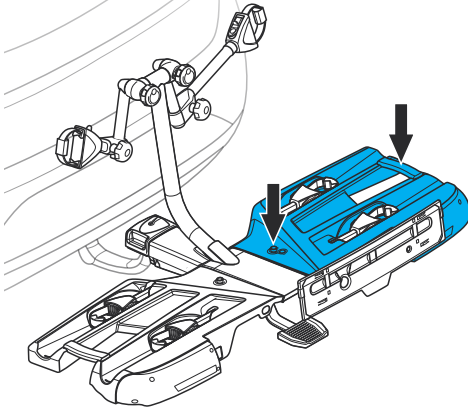



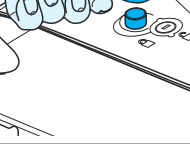
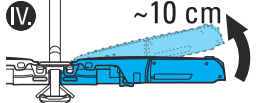

  47 kg  CLICK 	 < 47 kg 	 → 07
	 47 kg  OK	 → 08

07 



I		II	
III			
IV		 OK CLICK 	

~10 cm

< 47 kg			 → 07
47 kg		 OK	 → 08

08

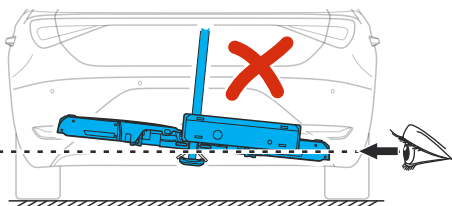
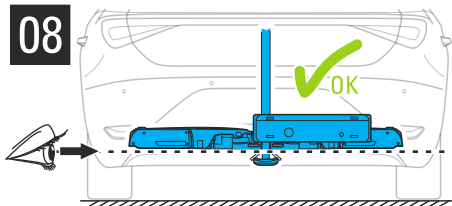

Using the
number
plate

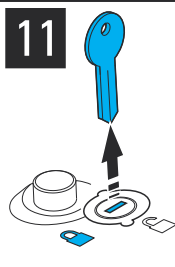
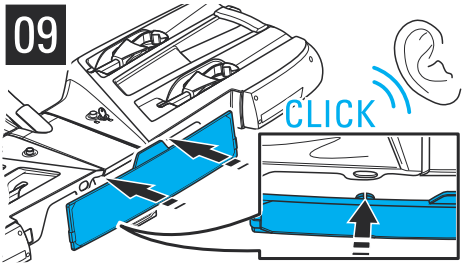
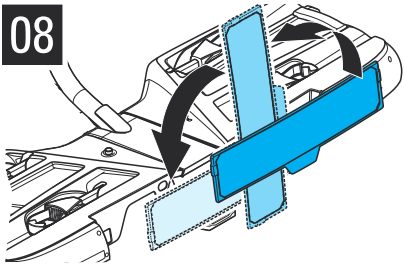
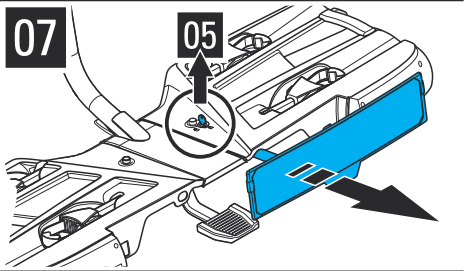
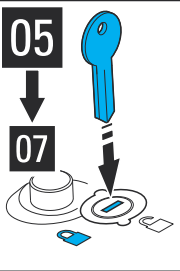
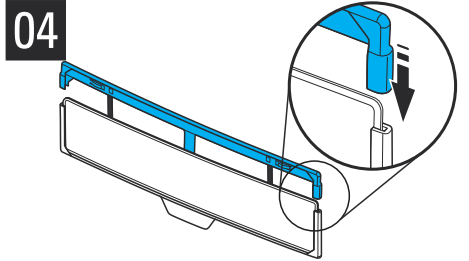
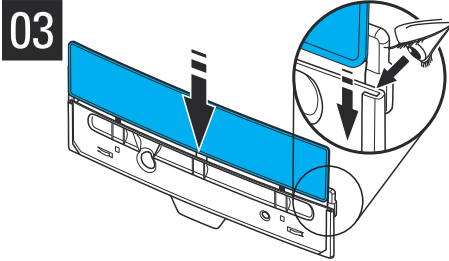
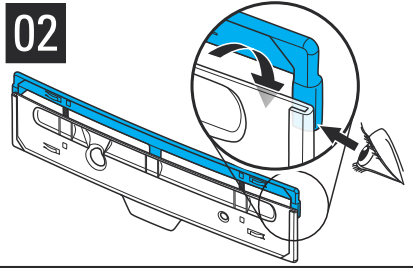
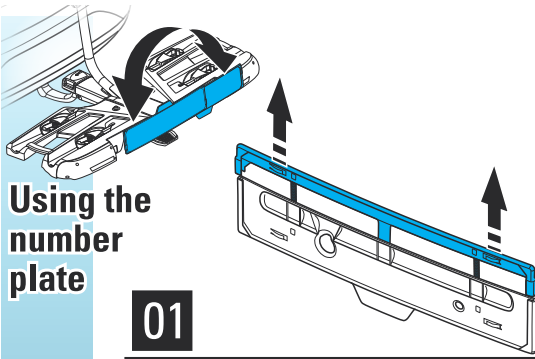

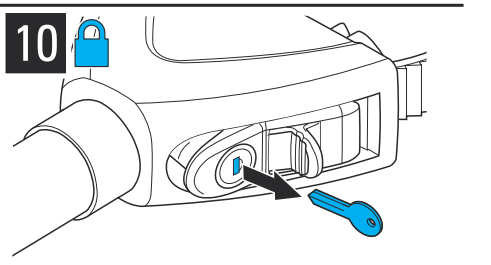
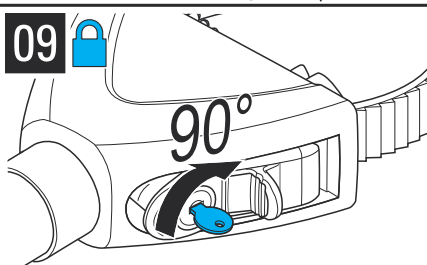
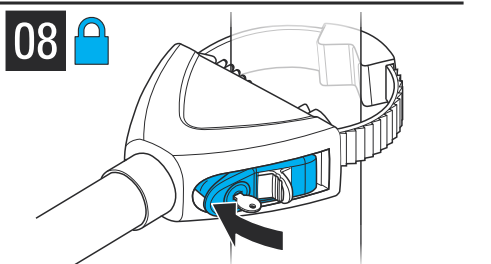
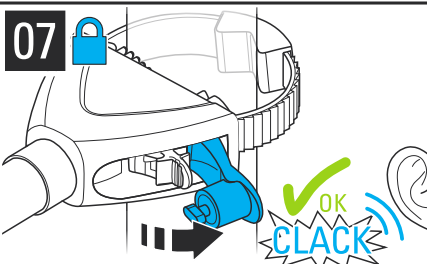
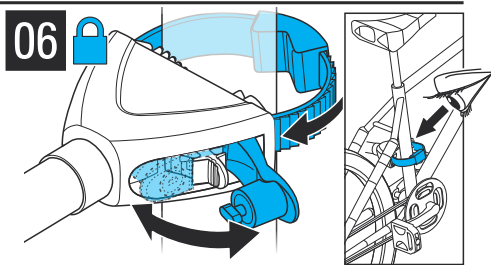
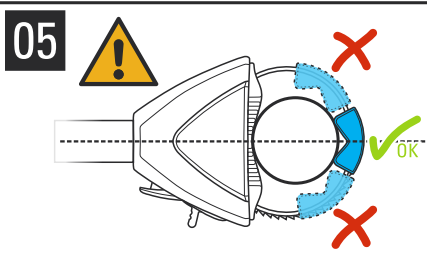
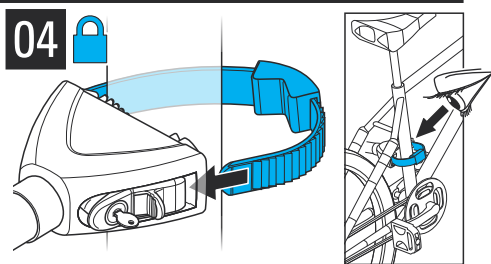
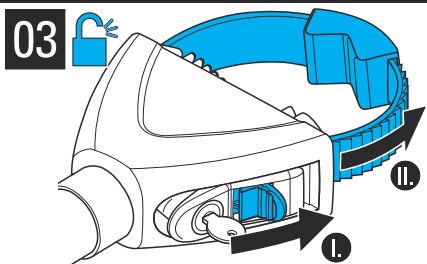
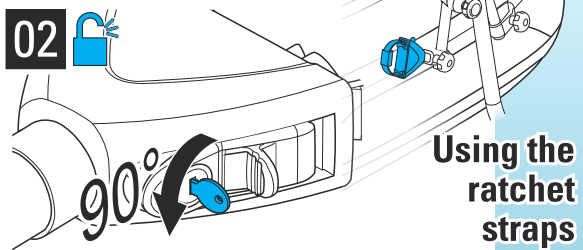
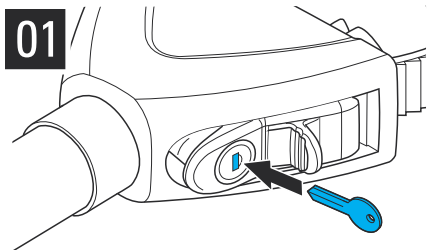

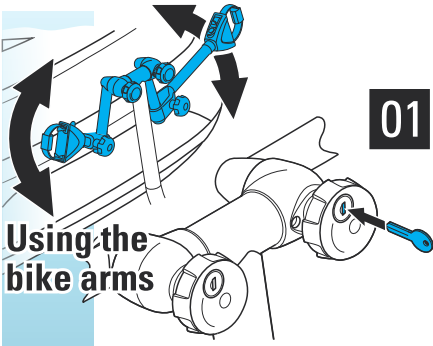

Using the bike arms

01

02

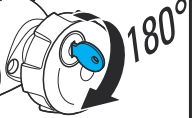

04

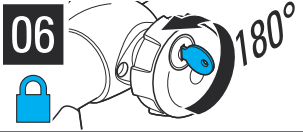
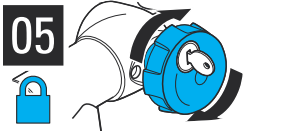
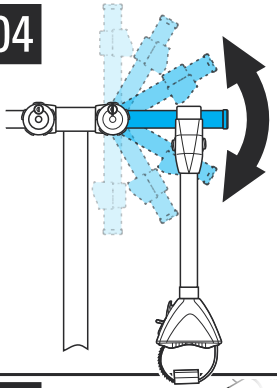

07

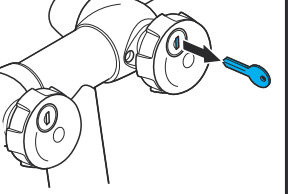

08

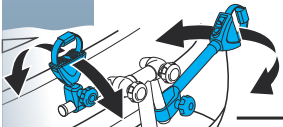
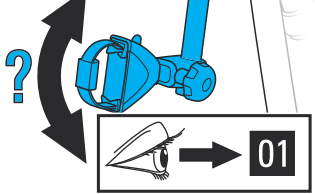

Using the bike arms

01

02

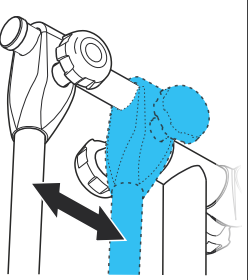

03

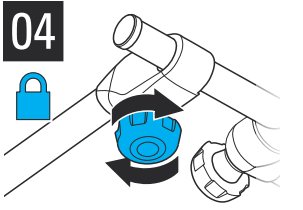
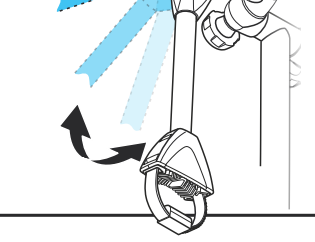

05

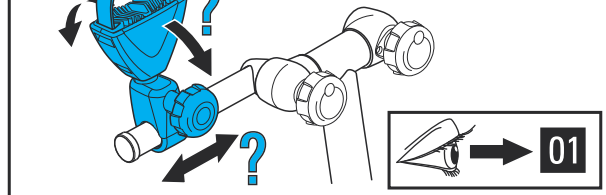

01

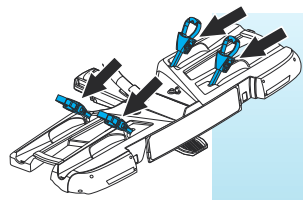
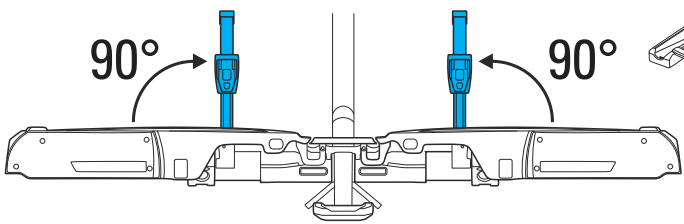

Using the wheel holder

02 

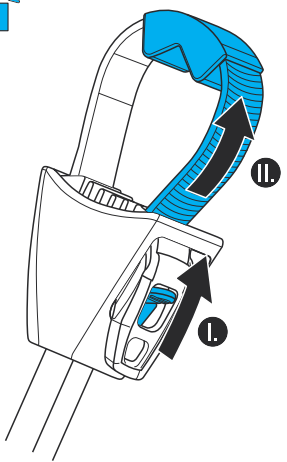

03 

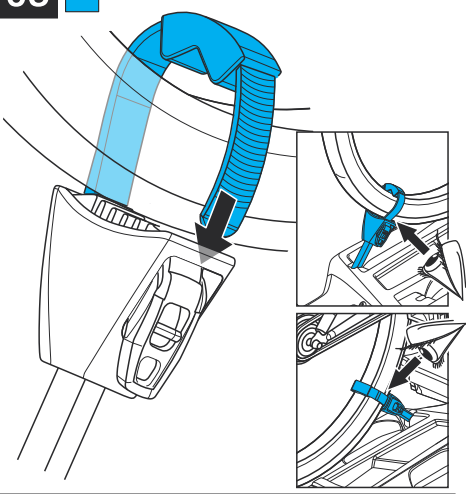

03

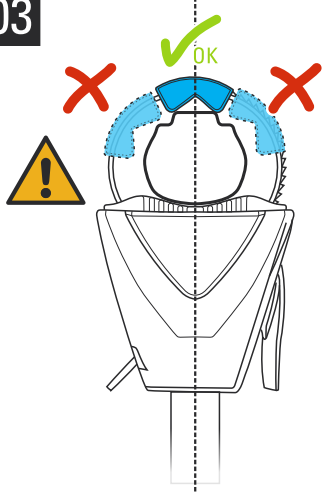

04 

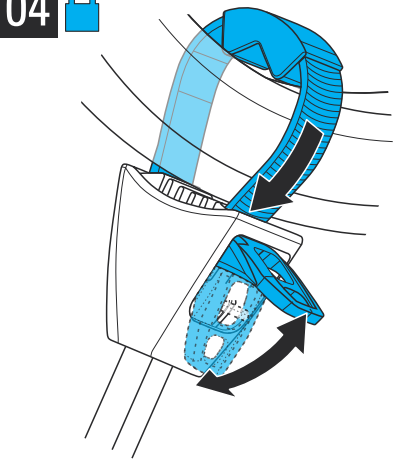

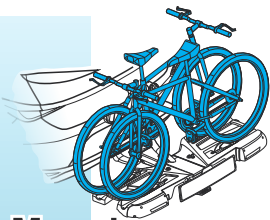

Mounting the bikes

- 1.
- 2.

MAX
60kg

MAX 30 kg
+
MAX 30 kg

60 kg
✓ OK

01

PAGE
13/24

02

PAGE
15/24

03

04

PAGE
13/24

05

PAGE
15/24

06

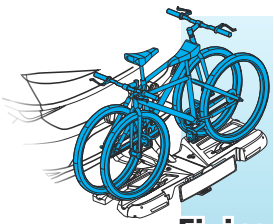
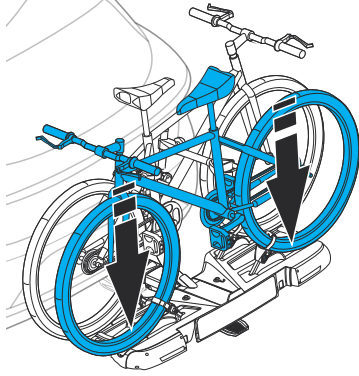

Fixing the bikes

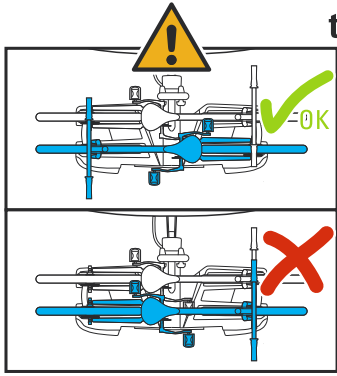
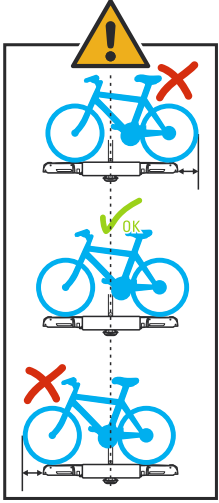

07



PAGE 13/24

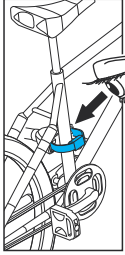

08



PAGE 15/24

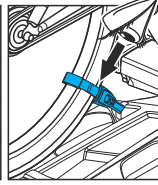
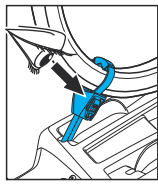

09

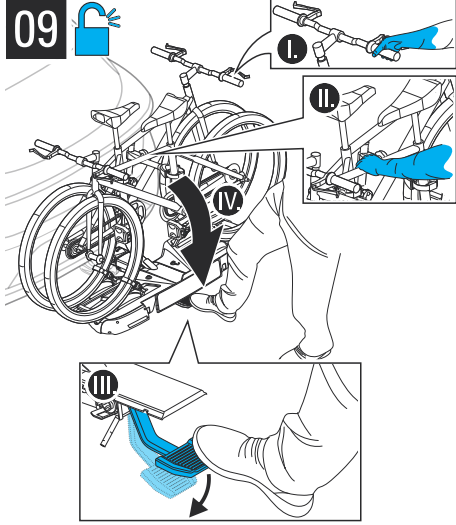

10

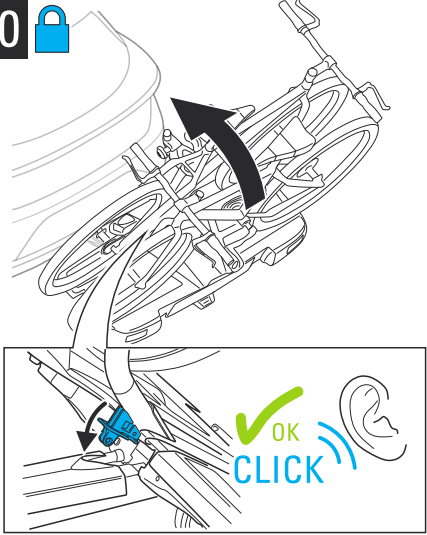

ORIS
ACPS

17/24

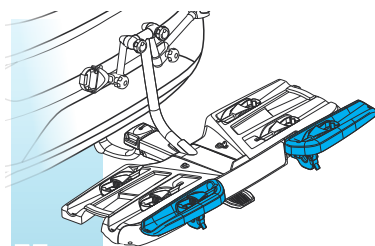

Mounting the 3rd bike extension

01

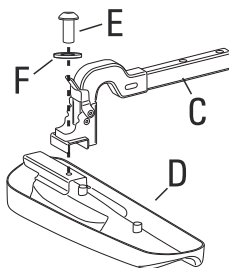

02

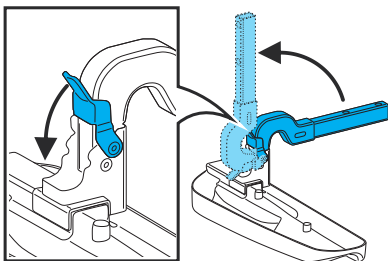

03

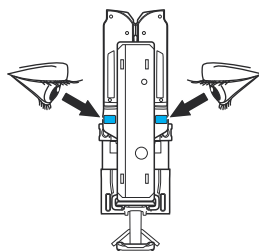

04

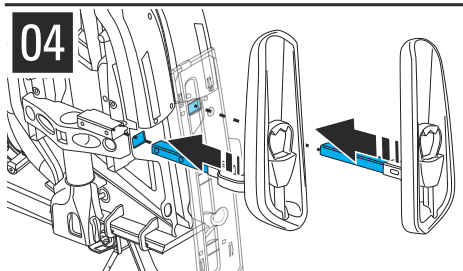

05

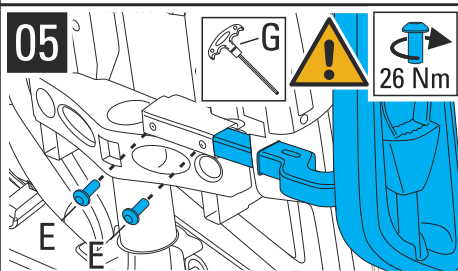

06

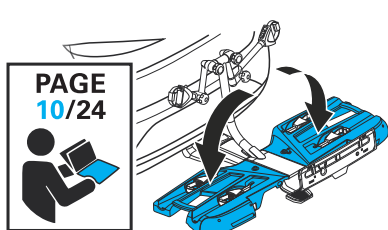

PAGE 10/24

07

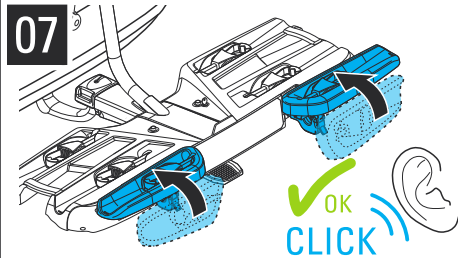

08

PAGE 15/24

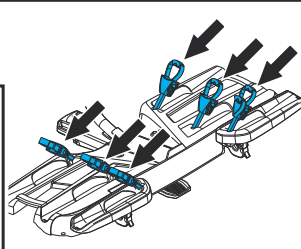

1. → 30 kg + 25 kg
2. → 30 kg + 23 kg
3. → 20 kg + 12 kg

MAX 60kg

80 kg 60 kg

OK

09

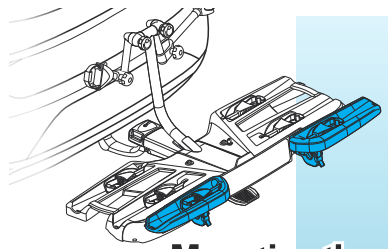
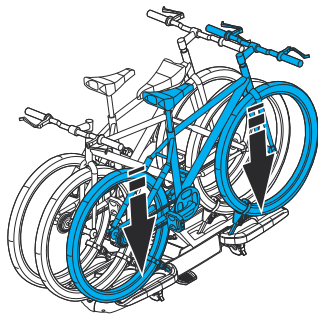

Mounting the 3rd bike extension

10

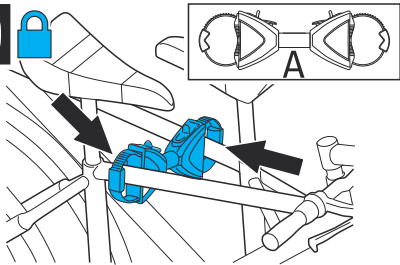

PAGE 13/24

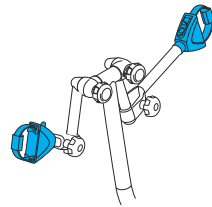

11

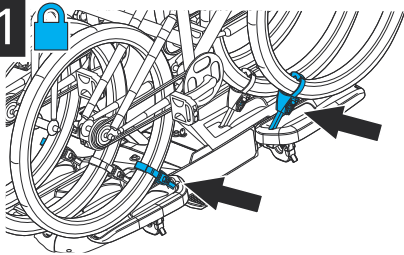

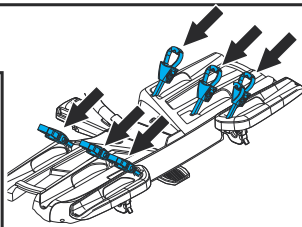

PAGE 15/24



Attention!  **Achtung!**

While driving the 3rd wheel rail always has to be fold up! Otherwise, the taillight is covered!

Während der Fahrt muss die dritte Radschiene immer aufgestellt sein! Ansonsten wird das Rücklicht des Fahrradträgers verdeckt!

  **HOCH KLAPPEN!**
FOLD UP!

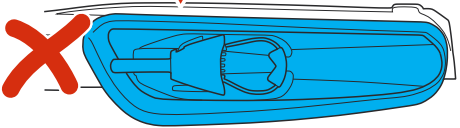
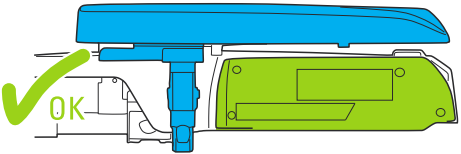
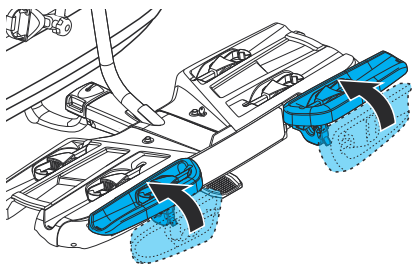
Removing the number plate

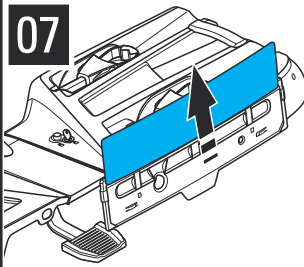
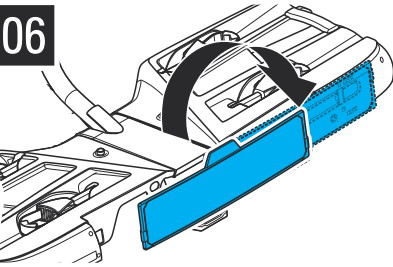
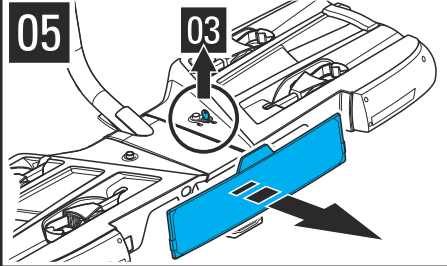
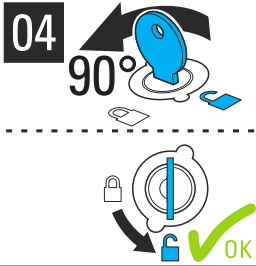
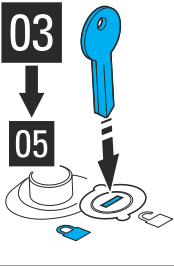
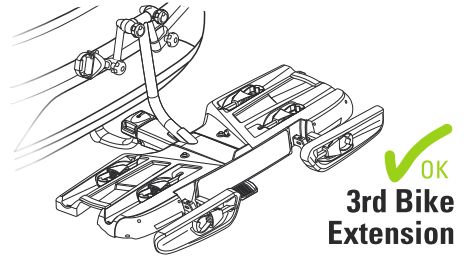
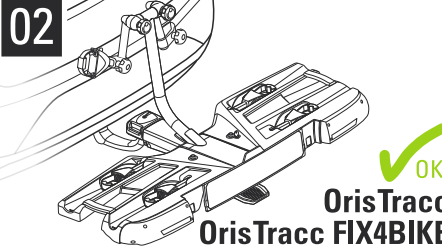
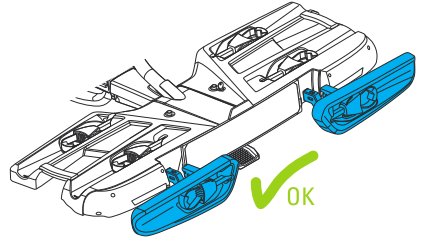
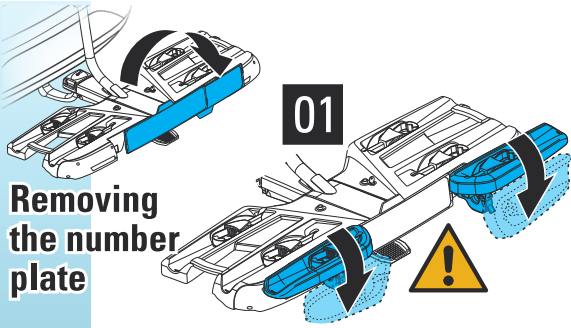

01 

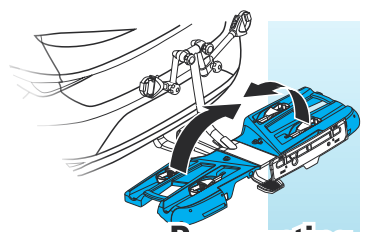
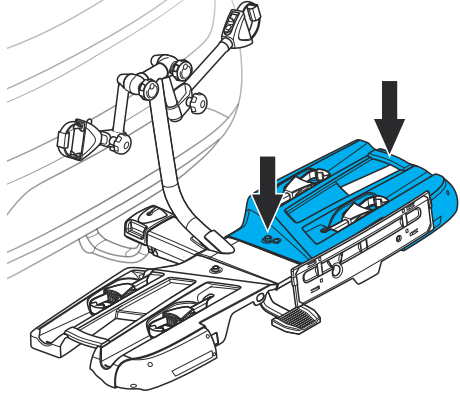

Demounting from the Vehicle

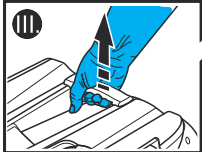
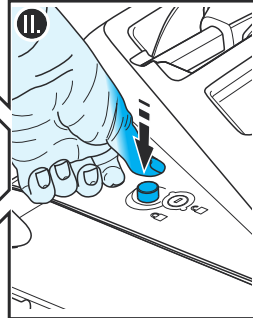
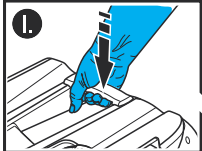

02

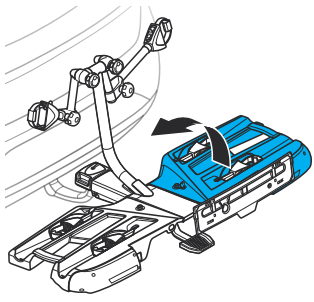

03

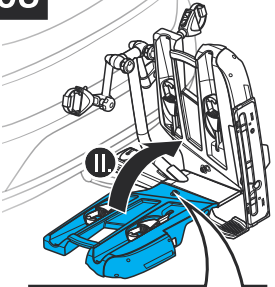

04

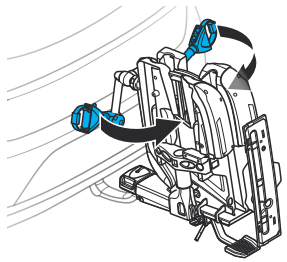

05

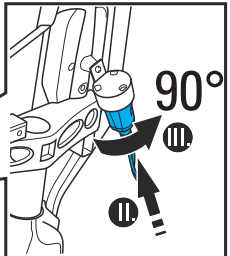
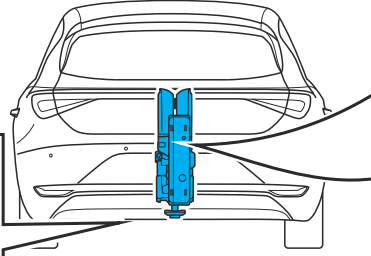
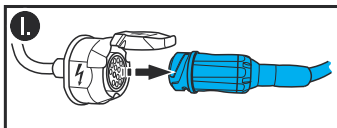

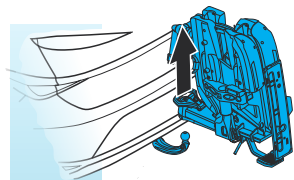

Demounting the FIX4BIKE System

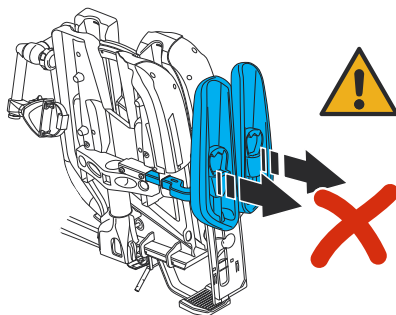

 **3rd Bike Extension**

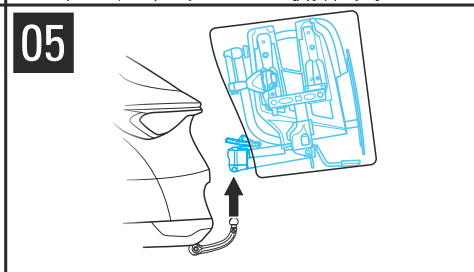
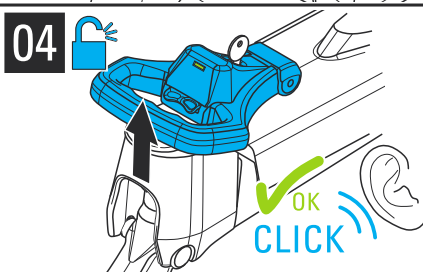
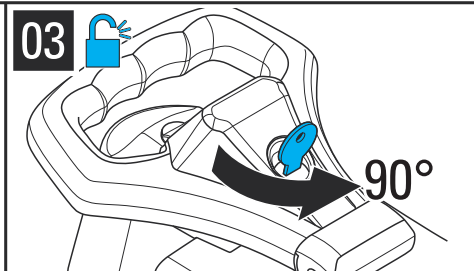
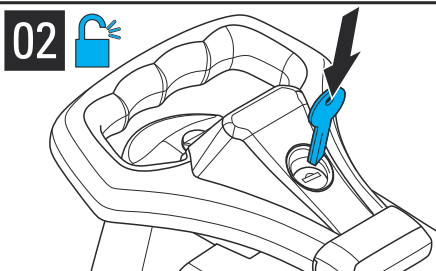
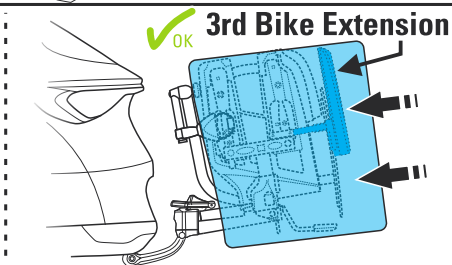
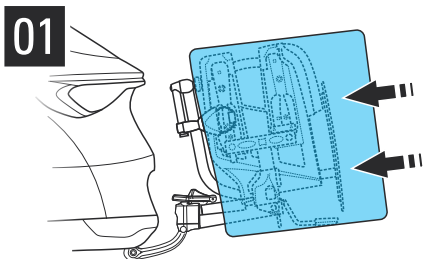

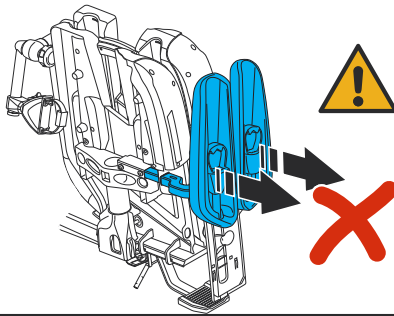

3rd Bike Extension

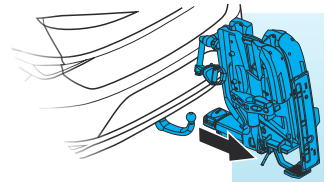

Demounting the Standard System

01

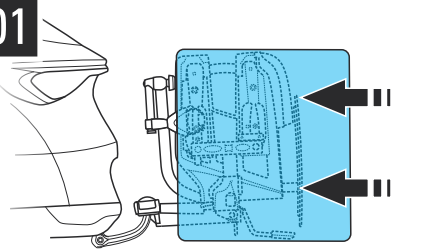

✓ OK

3rd Bike Extension

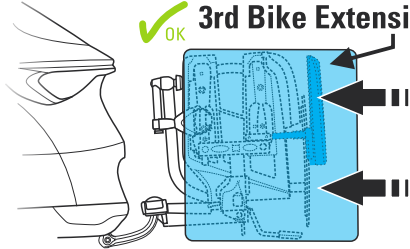

02

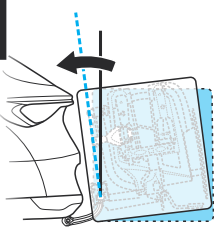

03

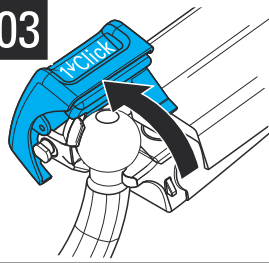

04

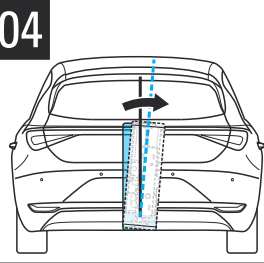

05

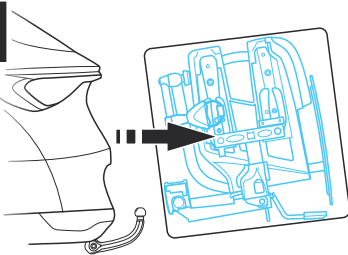

06

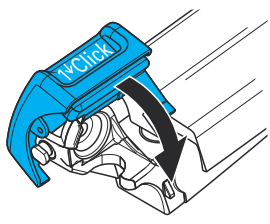

ACPS Automotive Services GmbH
Regioparkring 1
41199 Mönchengladbach, Germany
Germany

Phone: +49 2166 943 980 0
Fax: +49 2166 943 980 100
Mail: BDEV.Sales@acps-automotive.com
