

IN-202

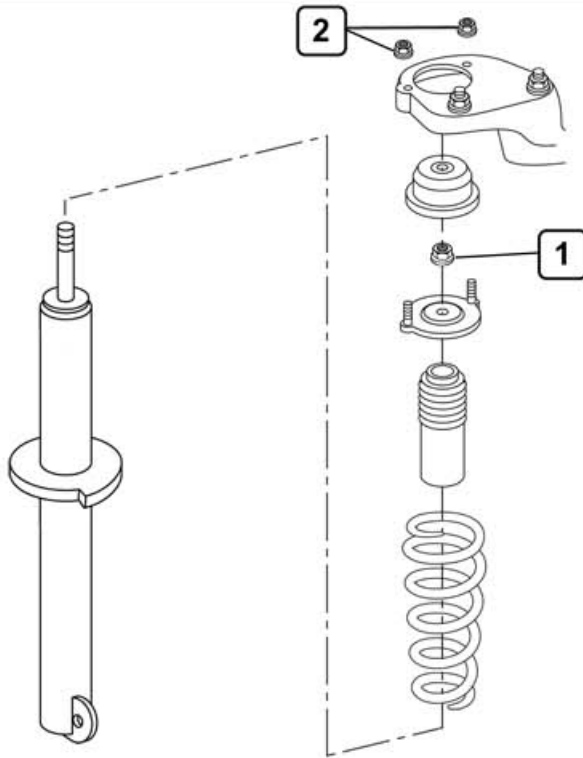

- 1** 33 Nm
- 2** 27 Nm
- 3** 122 Nm
- 4** 33 Nm
- 5** 29 Nm



O.E
 KYB

