

x 2

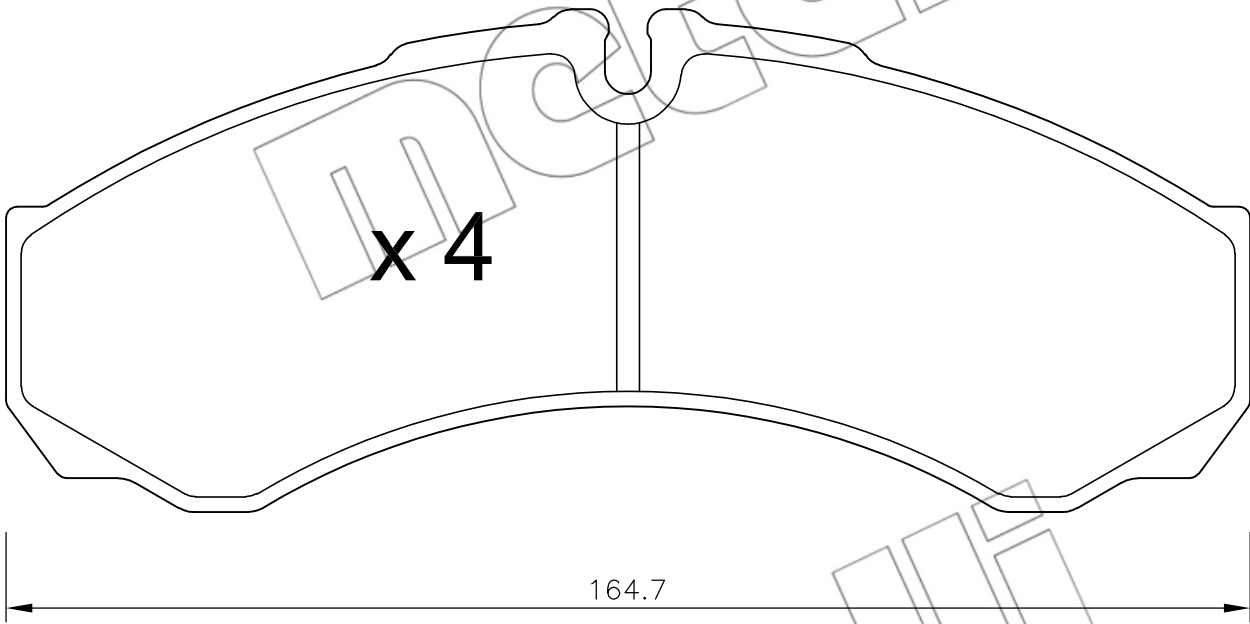

L = 260

x 4



66.6

164.7

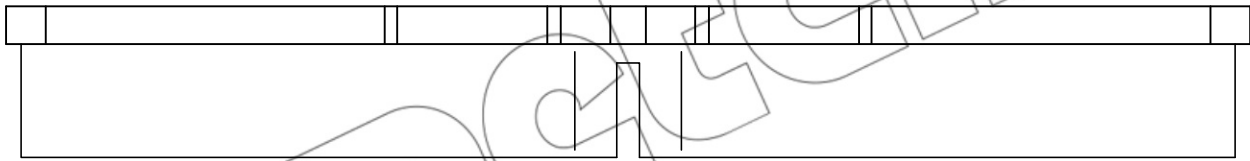

20

metelli