

## IN-169

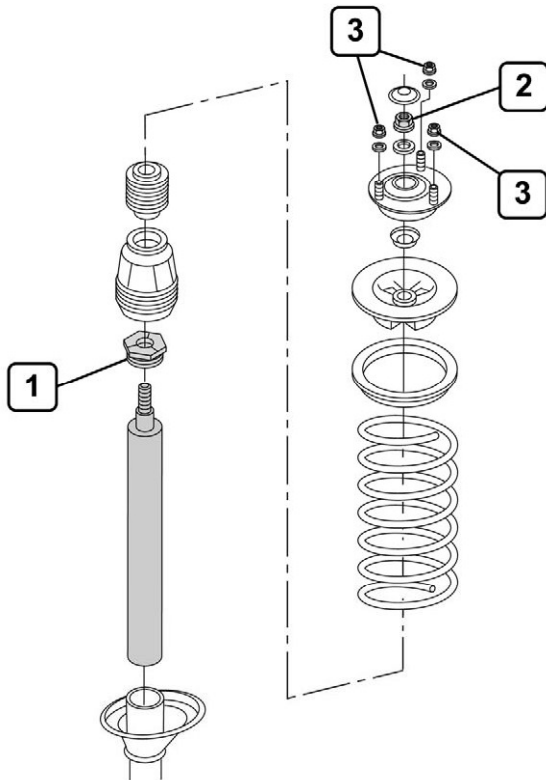

- |                 |                |
|-----------------|----------------|
| <b>1</b> 200 Nm | <b>5</b> 40 Nm |
| <b>2</b> 60 Nm  | <b>6</b> 18 Nm |
| <b>3</b> 30 Nm  | <b>7</b> 80 Nm |
| <b>4</b> 70 Nm  |                |



 O.E  
 KYB

