

IN-024

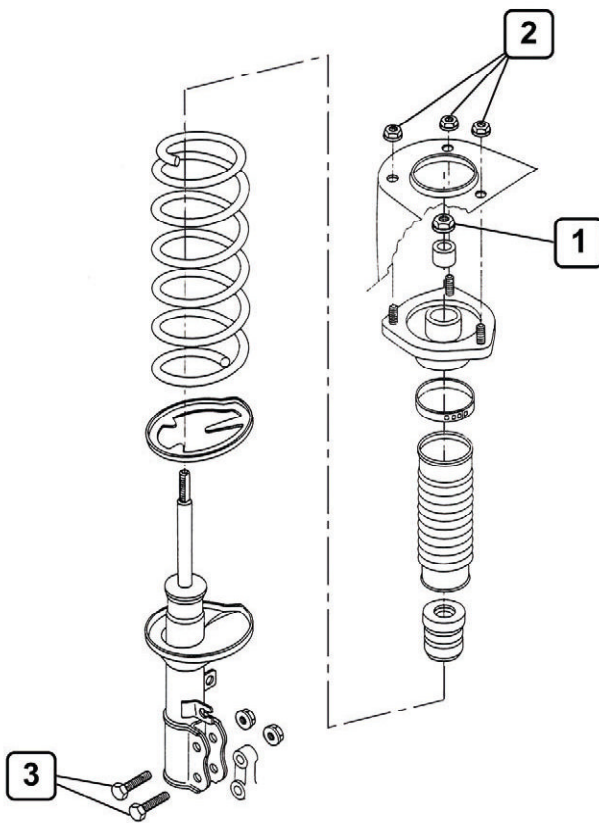

- 1** 49 Nm
- 2** 39 Nm
- 3** 226 Nm
- 4** 35 Nm



O.E
KYB

