

x 2

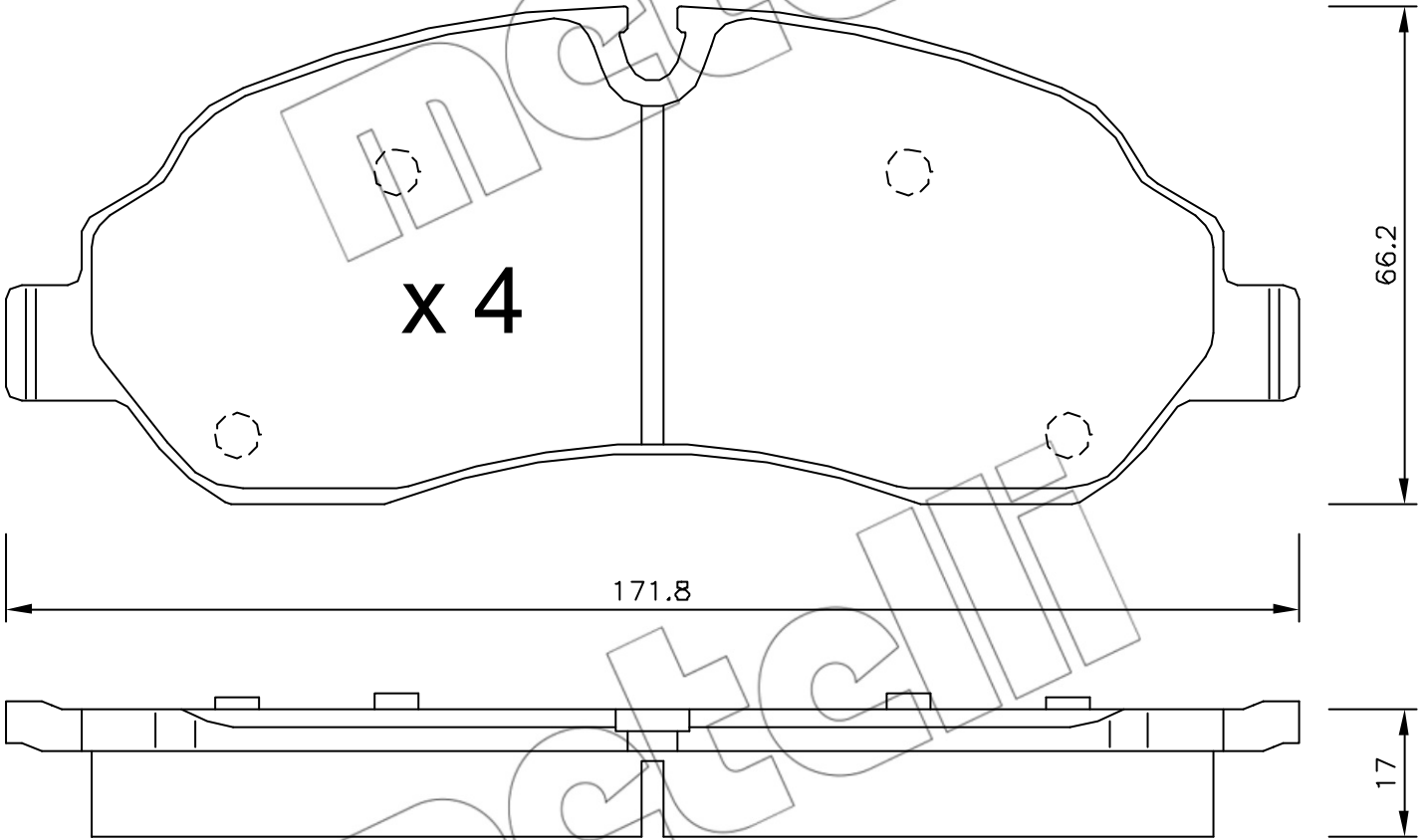

$L = 315$

x 4



171.8

66.2

17

metelli