

x 2

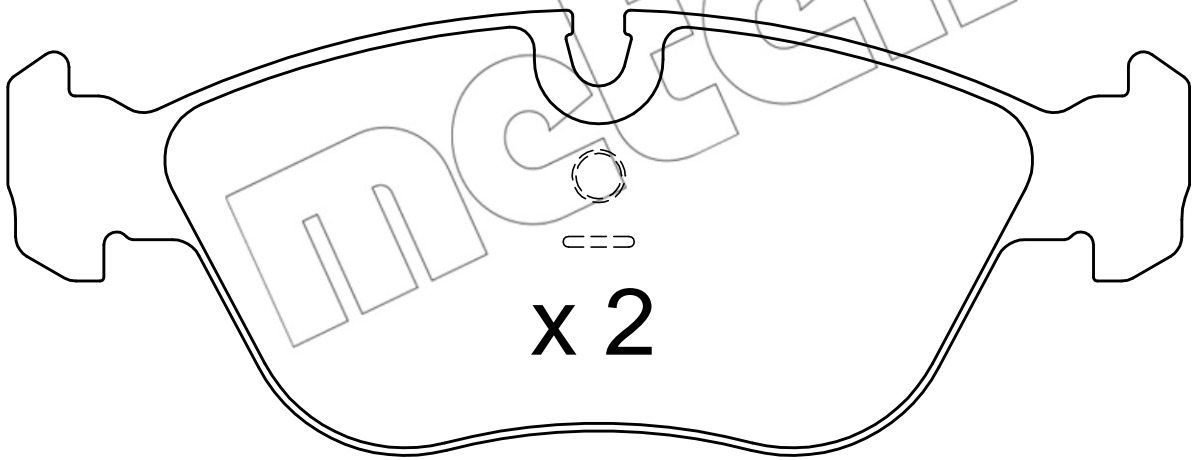
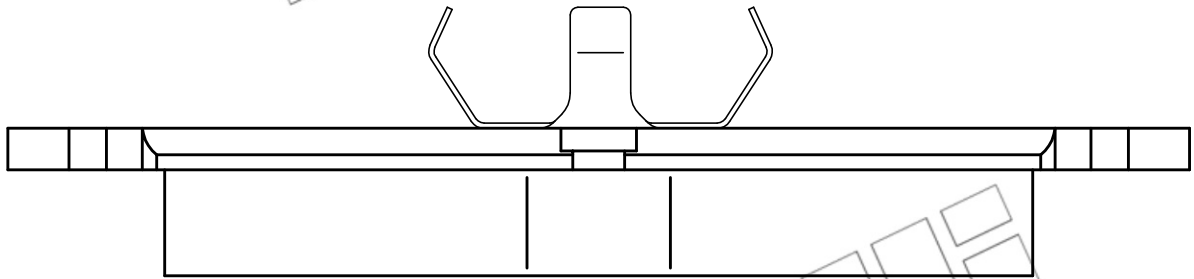

x 2

156.5

59.1

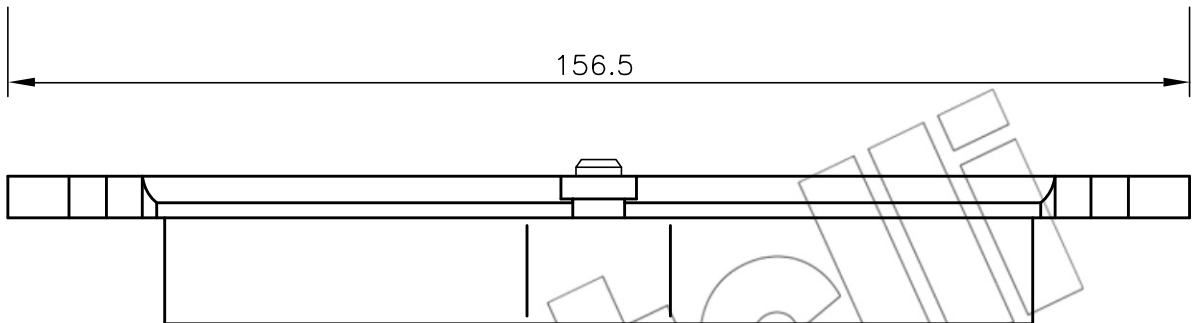

19.5