

x 2

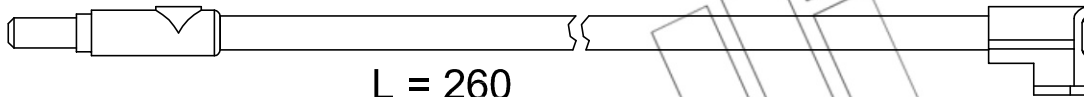

L = 260

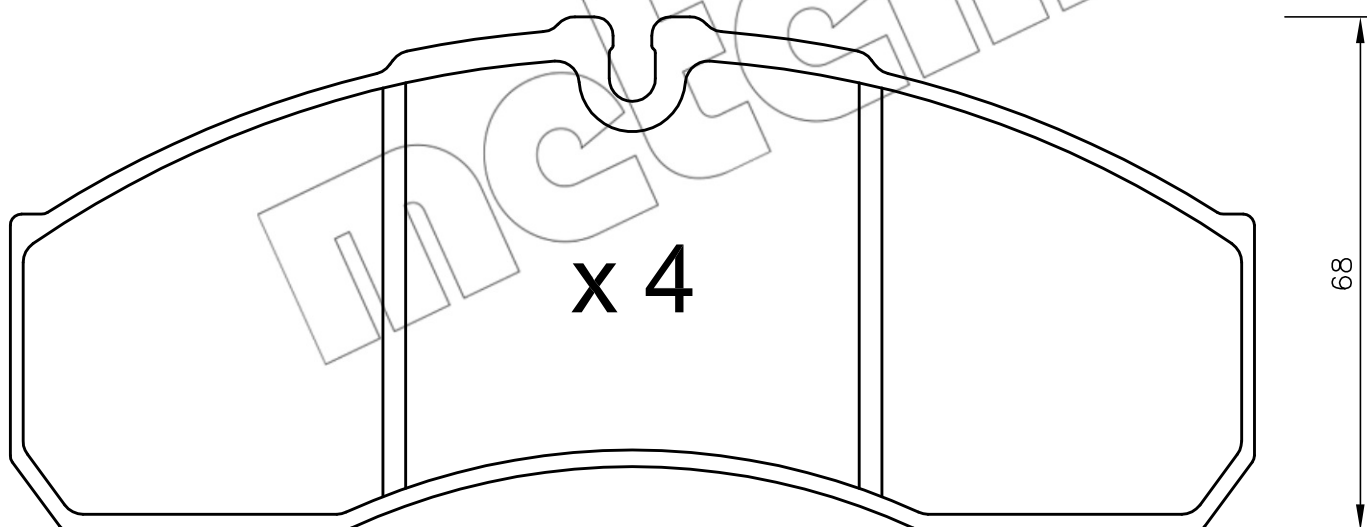

x 4

68

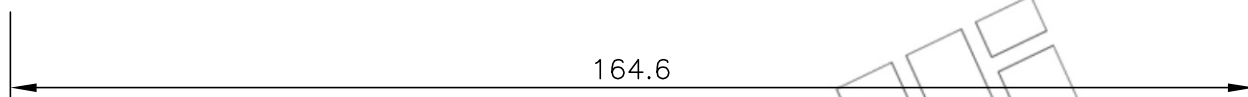

164.6

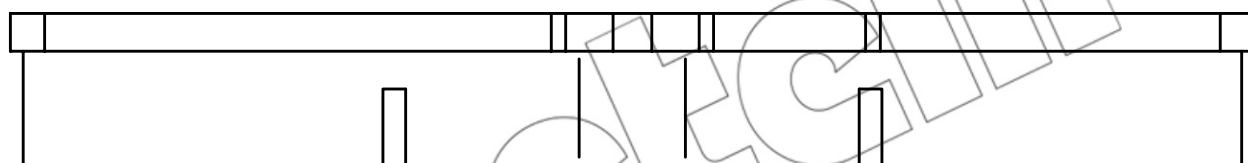

20

metelli