

IN-136

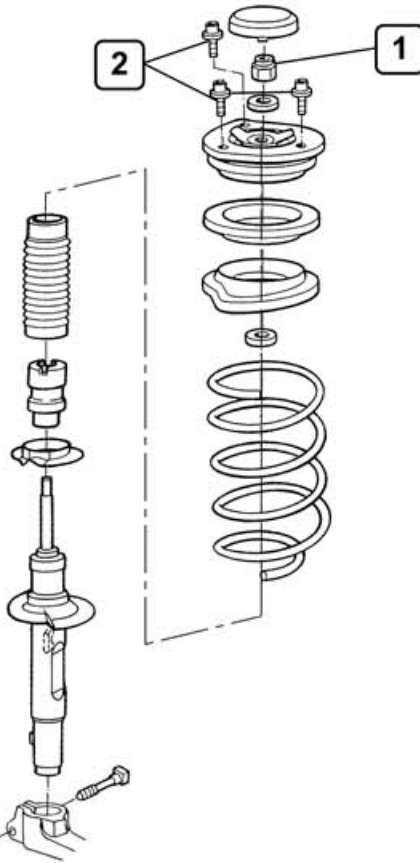

- 1 65 Nm
- 2 40 Nm
- 3 55 Nm
- 4 65 Nm



O.E
KYB

