

**IN-157**

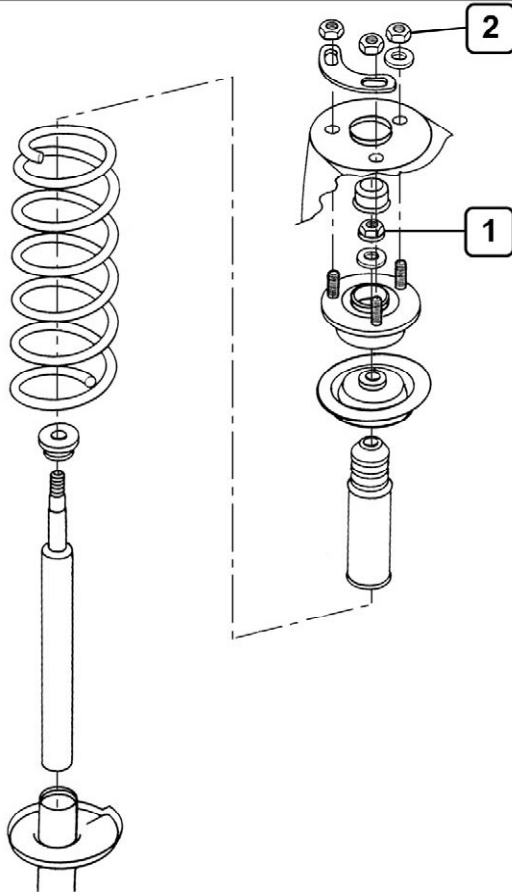

- 1** 20 Nm
- 2** 20 Nm
- 3** 60 Nm



 O.E  
 KYB

