

IN-101

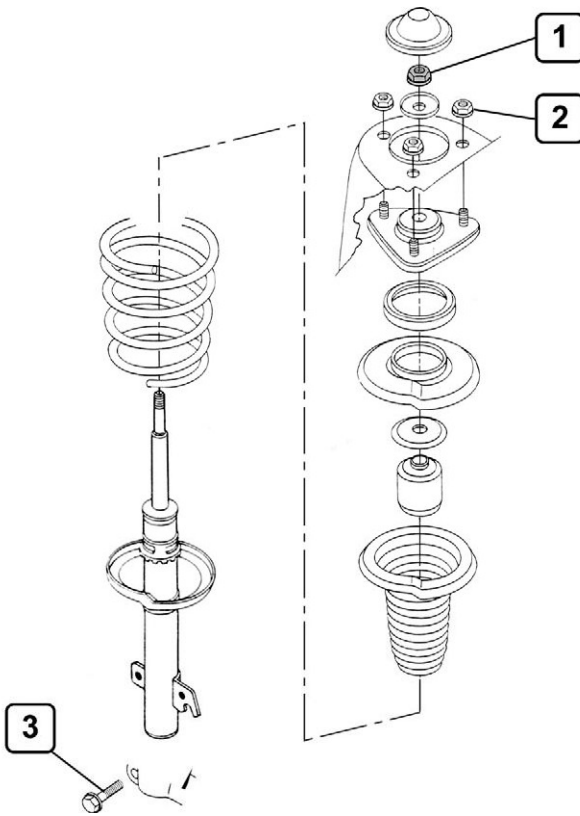

- 1** 40 Nm
- 2** 100 Nm
- 3** 32 Nm
- 4** 25 Nm



 O.E
 KYB

