

x 1

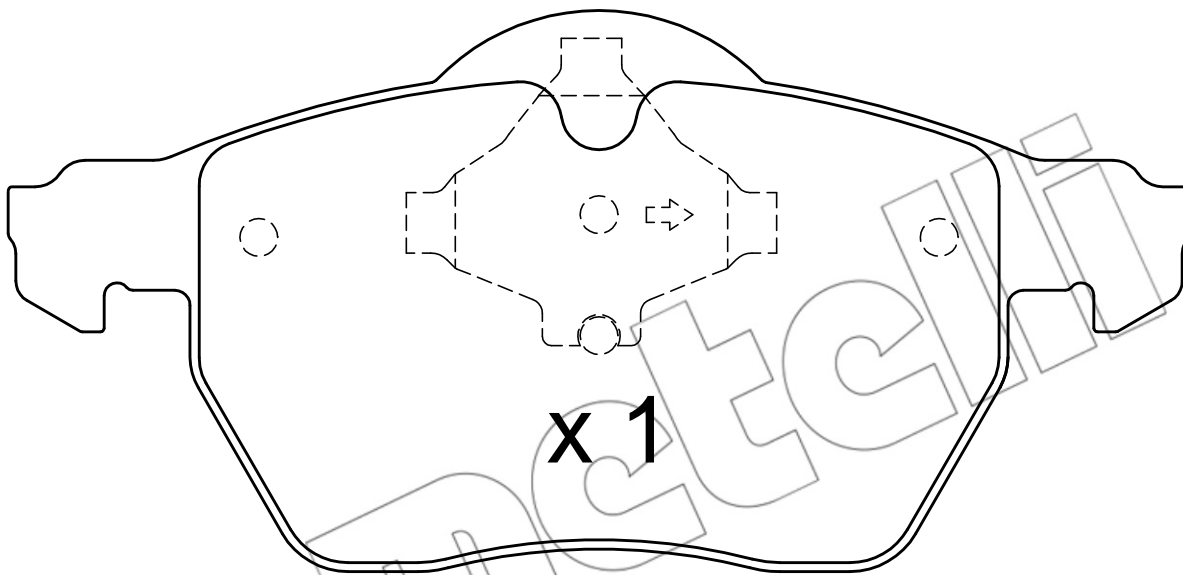

x 1

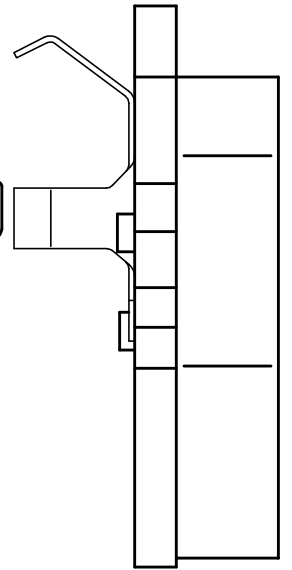
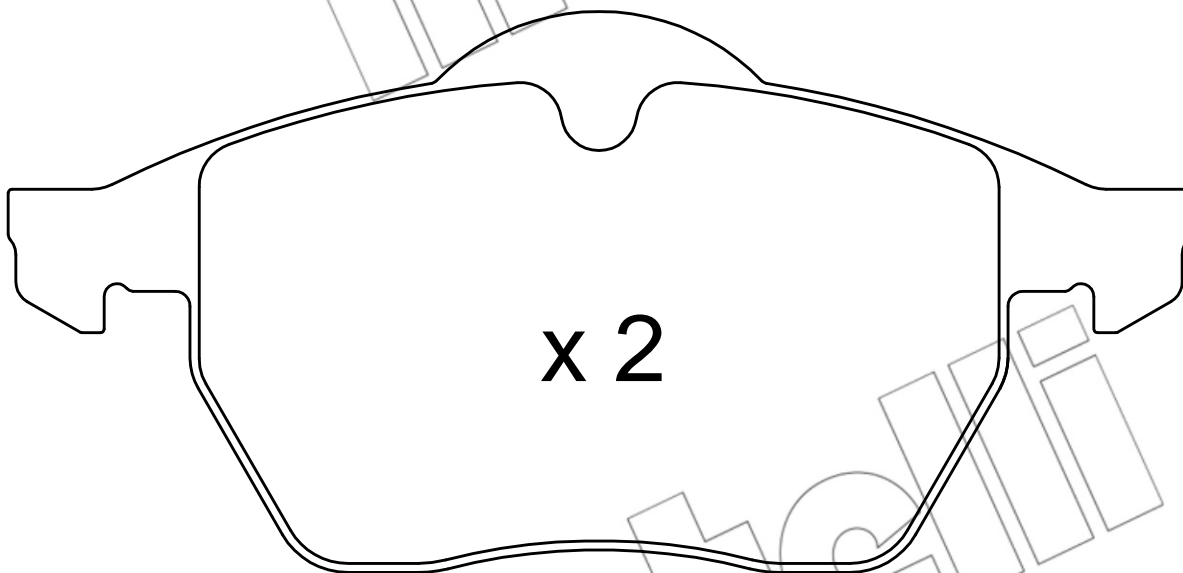
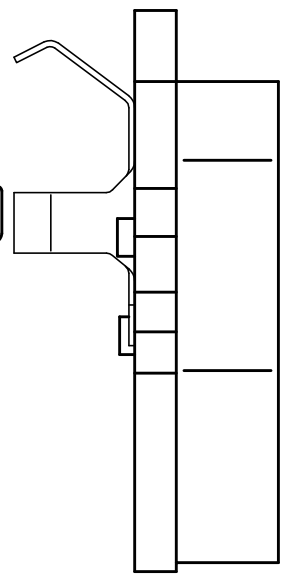

x 2

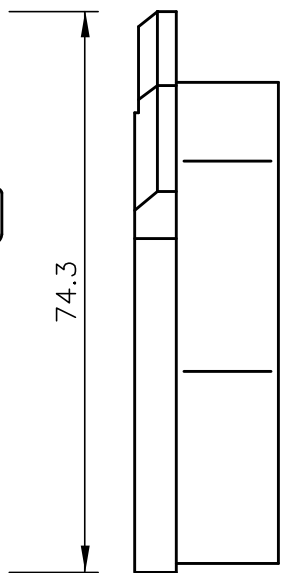

156.4

74.3

19