

x 2

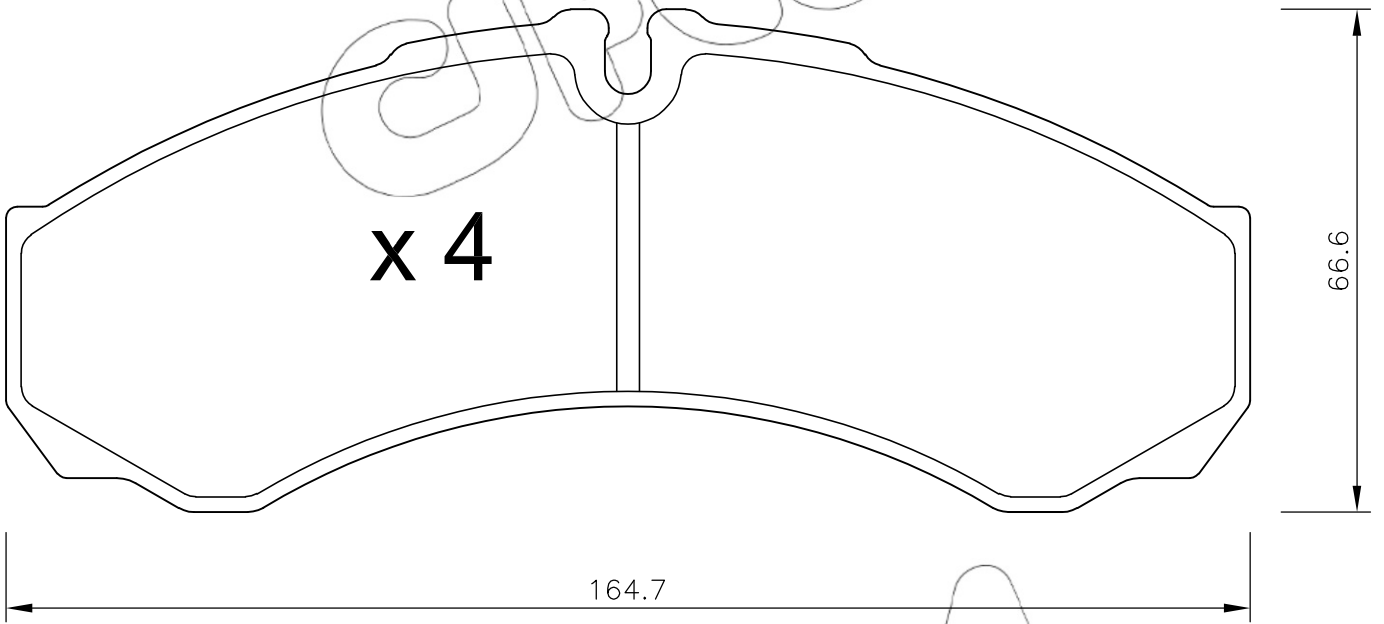

L = 260

x 4



164.7

66.6

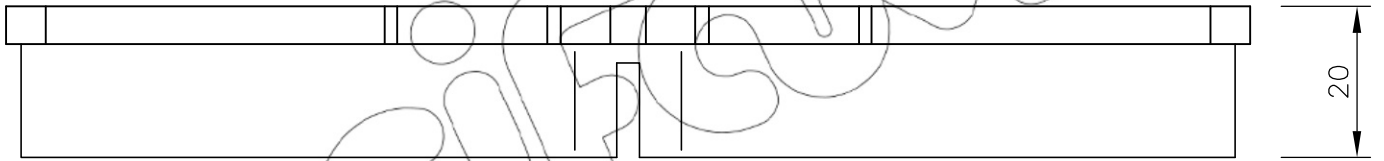

20

difom