

IN-047

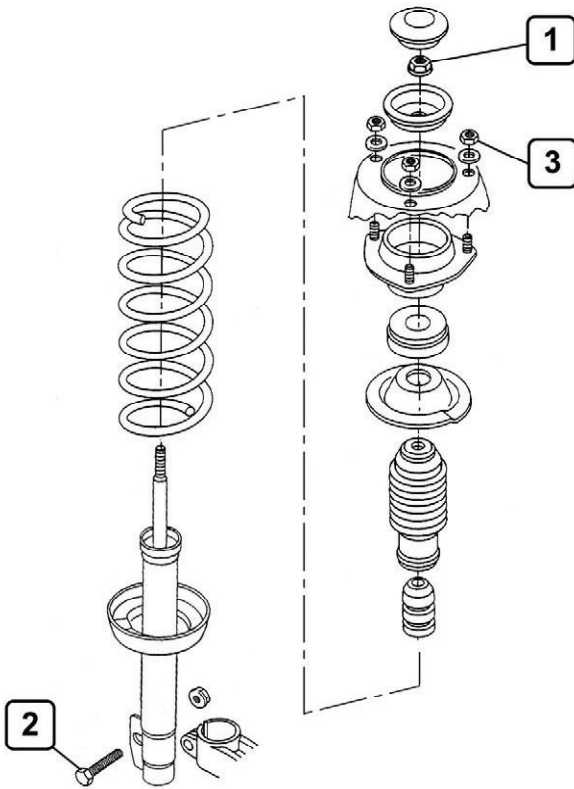

- 1** 46 Nm
- 2** 85 Nm
- 3** 46 Nm



 O.E
 KYB

