

MCK0580



PROCEDURA DI FASATURA VALVOLE

- [Precisazioni sulla coppia di serraggio viti](#)

MOTORI VW FSI E TFSI - Guida all'individuazione del corretto kit riparazione

PARAOILI IN FPM E PTFE - Istruzioni ed accorgimenti per la corretta installazione



VALVE TIMING PROCEDURE

- [Clarification on screw tightening torque](#)

VW FSI AND TFSI ENGINES - Correct repairing kit identification guide

FPM AND PTFE OIL SEALS - Instructions and precautions for proper installation



VENTILSTEUERUNG

- [Erklärung zum Schraubenanzugsmoment](#)

VW FSI- UND TFSI-MOTOREN - Anleitung zur Korrekten Identifizierung von Reparatursätzen

FPM- UND PTFE-ÖLDICHTUNGEN - Anweisungen und Vorsichtsmassnahmen für die Ordnungsgemässe Installatio



PROCÉDURE DE CALAGE DE LA CHAÎNE DE DISTRIBUTION

- [Précision sur le couple de serrage des vis](#)

MOTEURS VW FSI ET TFSI - guide d'identification du bon kit de réparation

JOINTS D'ÉTANCHÉITÉ FPM ET PTFE - Instructions et précautions pour une bonne installation



PROCEDIMIENTO DE REGULACIÓN DE LA VÁLVULA

- [Aclaración sobre el par de apriete de tornillos](#)

MOTORES VW FSI Y TFSI - Guía de identificación del kit de reparación correcto

FPM Y PTFE JUNTA DE ACEITE - Instrucciones y precauciones para una correcta instalación



SUPAP ZAMANLAMASI PROSEDÜRÜ

- [Vida sikma torku ile ilgili açıklama](#)

VW FSI VE TFSI MOTORLAR - Doğru tamir kiti belirleme kilavuzu

FPM VE PTFE YAĞ KEÇELERİ - Doğru takma yöntemine yönelik talimatlar ve önlemler

**MAGNETI
MARELLI**

PARTS & SERVICES

MCK0580

PROCEDURA DI FASATURA VALVOLE

Case automobilistiche: **Audi, Volkswagen**Modelli: **Audi A3, Volkswagen EOS, Golf V, Golf Plus, Jetta III, Passat VI, Touran**Codice Motore: **BAG, BLF, BLG, BLP, BMY**Potenza: **1.4 FSI, 1.4 TSI, 1.6 FSI (115, 140, 170 CV)**Anno: **02/2003** →

Precauzioni generali

- Staccare sempre il cavo di massa della batteria.
- Togliere le candele di accensione per far girare più facilmente il motore.
- Girare sempre il motore nel senso normale di rotazione (salvo indicazione contraria).
- Osservare le coppie di serraggio.
- Se in dotazione: contrassegnare la posizione del sensore di posizione albero motore prima di procedere allo smontaggio.
- **NON** ruotare l'albero motore agendo sull'albero a camme o su altri pignoni.
- **NON** ruotare l'albero motore o l'albero a camme con la catena della distribuzione smontata.

Procedure di fasatura valvole

- Per smontare/montare la catena della distribuzione è necessario:
 - Smontaggio del coperchio della distribuzione.
 - Smontaggio della coppa.

! *Contrassegnare la direzione di rotazione sulle catene.*

- Montare il comparatore e il supporto nel foro candela del cilindro n. 1. Accertarsi che il motore si trovi al PMS del cilindro n. 1 **1**.
- Accertarsi che le tacche di fasatura sugli alberi a camme siano allineate come illustrato **2**.
- In caso contrario, ruotare l'albero motore di 360°.
- Montare l'attrezzo di allineamento alberi a camme **3**.
- **!** *Se l'attrezzo di allineamento alberi a camme non può essere inserito, la fasatura delle valvole non è corretta.*
- Comprimerne il tendicatena e bloccarlo con il perno di bloccaggio **4**.
- Smontare i pignoni alberi a camme e la catena.
- Allineare gli alberi a camme. Utilizzare l'attrezzo speciale **3**.
- Montare i pignoni alberi a camme e la catena della distribuzione.

• Motori con fasatura valvole variabile:

Installare un nuovo bullone. Serrare il bullone del dispositivo di registrazione albero a camme di aspirazione **5**. Coppia di serraggio: 40 Nm + 90°.

! *Il bullone del pignone albero a camme di aspirazione ha una filettatura sinistrorsa.*

• Motori senza fasatura valvole variabile:

Serrare il bullone del pignone albero a camme di aspirazione **6**. Coppia di serraggio: 50 Nm + 90°.

- Serrare il bullone del pignone albero a camme di scarico. Coppia di serraggio: 50 Nm + 90°.
- Serrare il bullone della puleggia albero motore. Coppia di serraggio **7**:
 - A = 150 Nm + 180°
 - B = 90 Nm + 90°.

! *Il bullone della puleggia albero motore e il bullone di ogni pignone albero a camme DEVONO essere utilizzati soltanto una volta.*

- Smontare l'attrezzo di allineamento alberi a camme. Ruotare l'albero motore in senso orario di due giri.
- Controllare la fasatura delle valvole **3**.

Attrezzi speciali

- Comparatore a quadrante - n. VAS 6079.
- Supporto comparatore a quadrante - n. T10170.
- Attrezzo di allineamento albero a camme - n. T10171.
- Attrezzo di bloccaggio pignone albero a camme/pompa dell'olio - n. T10172.
- Attrezzo di bloccaggio albero motore - n. T10340.
- Attrezzo di bloccaggio puleggia albero motore - n. 3415.
- Perno di bloccaggio tendicatena - n. T40011.

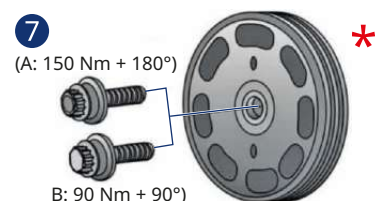
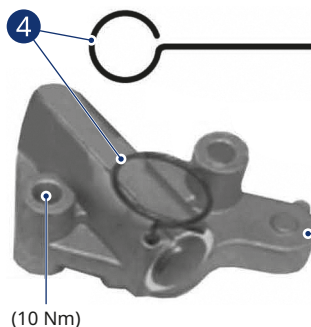
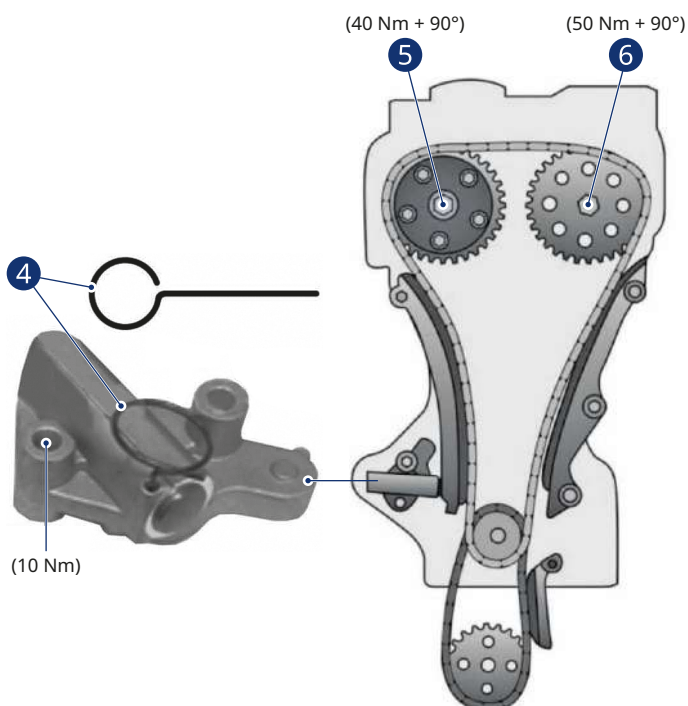
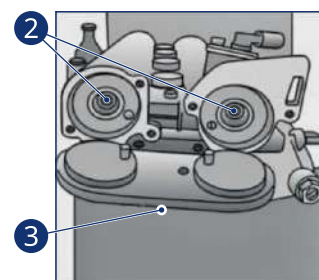
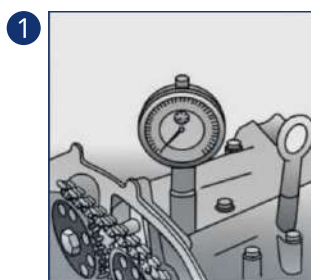

! Il tendicatena contenuto in questo kit è caricato a molla e potrebbe provocare danni se maneggiato non correttamente. **NON** rimuovere il perno finché non è completamente installato ed assicurarsi sempre che il pistone sia rivolto lontano da voi e da chiunque altro in un raggio di 20 metri.

Le istruzioni, le raccomandazioni e le informazioni contenute nella presente pubblicazione sono state formulate con la massima cura. Marelli Aftermarket Italy S.p.A., in nome e per conto delle sue affiliate/consociate, non assume responsabilità per alcun tipo di danno anche derivante da errata interpretazione delle informazioni ivi contenute.



**MAGNETI
MARELLI**

PARTS & SERVICES

* PRECISAZIONI SULLA COPPIA DI SERRAGGIO VITI

Nella scheda informativa è riportata la seguente informazione:

- Serrare il bullone della puleggia albero motore.
Coppia di serraggio ⑦:
- A = 150 Nm + 180°
- B = 90 Nm + 90°.

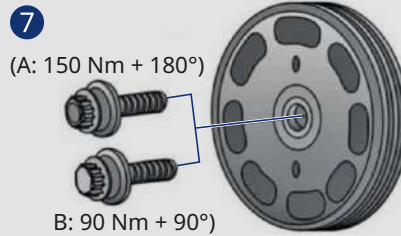

Due coppie di serraggio per un'unica vite. Quale delle due?

A

Se sul veicolo è installata una **vite a dodecaedro**, combinata, con testa perforata, classe di resistenza/categoria di 10.9, dimensioni M14x1,5x100, codice OE: N91048601 simile a quella riportata nelle foto:



La coppia massima di serraggio deve essere fissata a **150 Nm + 180°** (Caso A)

B

Se invece fosse presente una vite differente da quella mostrata in foto, "**senza testa della vite**" la coppia massima di serraggio deve essere fissata a **90 Nm + 90°** (Caso B)

**MAGNETI
MARELLI**

PARTS & SERVICES

Motori VW FSI e TFSI

GUIDA ALL'INDIVIDUAZIONE DEL CORRETTO KIT RIPARAZIONE

I motori tipo FSI e TFSI prodotti dal gruppo VW sono caratterizzati da una altissima complessità e variabilità nei componenti che rendono difficoltosa l'individuazione del corretto kit sostituzione della catena distribuzione. Di seguito viene riportato uno schema che, tenendo conto dei componenti installati sul veicolo, aiuta ad individuare il kit da utilizzare.

VW FSI and TFSI engines

CORRECT REPAIRING KIT IDENTIFICATION GUIDE

VW group FSI and TFSI engine-type are characterized by high complexity and components variability which make it difficult the identification of the correct timing chain repairing kit. Here below a scheme which, considering the components installed on the vehicle, helps to identify the right kit to be used.

LEGENDA | SYMBOL LEGEND

PERIODO DI APPLICABILITÀ APPLICABILITY PERIOD	Completo periodo di produzione Whole production period		XXX → XXX Applicabilità da anno ad anno Applicability from year to year			
	Cambio automatico Automatic transmission		Cambio manuale Manual transmission		Direct-Shift Gearbox	
	4WD Trazione integrale 4-Wheels Drive		AWD Trazione integrale All-Wheels Drive		FWD Trazione anteriore Front-Wheels Drive	
	Pignone Sprocket		Catena Chain		Tenditore Tensioner	
TRASMISSIONE TRANSMISSION TYPE	DESCRIZIONE PRODOTTO PARTS DESCRIPTION		CODICE COSTRUTTORE OE REFERENCE		NOTE NOTES	
TRAZIONE TRACTION TYPE					Numero telaio Chassis number	Numero motore Engine number
					→ XXX Fino a XXX To XXX	XXX → Da XXX From XXX
CODICI MAGNETI MARELLI MAGNETI MARELLI REFERENCES						
A1 (8X1, 8XK) 1.4 TFSI	(05/10 → 04/15)	CAXA; CNVA	90 kW			
Veicolo Vehicle	Anno di produzione Production year	Codice motore Engine code	Potenza motore Engine power			

Le istruzioni, le raccomandazioni e le informazioni contenute nella presente pubblicazione sono state formulate con la massima cura. Marelli Aftermarket Italy S.p.A., in nome e per conto delle sue affiliate/consociate, non assume responsabilità per alcun tipo di danno anche derivante da errata interpretazione delle informazioni ivi contenute.

The instructions, the recommendations and the information contained in this publication have been prepared with the utmost attention. Marelli Aftermarket Italy S.p.A., in the name and on behalf of its affiliates/subsidiaries, does not assume responsibility for any type of damage even deriving from incorrect interpretation of the information therein contained.

**MAGNETI
MARELLI**

PARTS & SERVICES

		PARTS	OE		COMPLETE KIT	EASY KIT
AUDI						
A1 (8X1, 8XK) 1.4 TFSI (05/10 → 04/15) CAXA; CNVA 90 kW						
			03C 105 209 AQ	Z = 18/18	MCK1210	MCK1240
			03C 115 225 A	54 Maglie/Links		
			03C 109 507 AD			
A1 (8X1, 8XK) 1.4 TFSI (01/11 → 04/15) CAVG; CTHG; CTJA 136 kW						
			03C 105 209 AG	Z = 23/18	MCK1200	MCK1240
			03C 115 225	56 Maglie/Links		
			03C 109 507 AF			
A1 Sportback (8XA, 8XF) 1.4 TFSI (11/11 → 04/15) CAXA; CNVA 90 kW						
			03C 105 209 AQ	Z = 18/18	MCK1210	MCK1240
			03C 115 225 A	54 Maglie/Links		
			03C 109 507 AD			
A1 Sportback (8XA, 8XF) 1.4 TFSI (11/11 → 04/15) CAVG; CTHG; CTJA 136 kW						
			03C 105 209 AG	Z = 23/18	MCK1200	MCK1240
			03C 115 225	56 Maglie/Links		
			03C 109 507 AF			
A3 (8P1) 1.6 FSI (08/03 → 09/07) BAG; BLF; BLP 85 kW						
			03C 105 209 AC / BE	Z = 18/18	MCK0580	MCK1240
			03C 115 230 C	54 Maglie/Links		
			03C 109 507 AE / J			
A3 Sportback (8PA) 1.6 FSI (09/04 → 09/07) BLF; BLP 85 kW						
			03C 105 209 AC / BE	Z = 18/18	MCK0580	MCK1240
			03C 115 230 C	54 Maglie/Links		
			03C 109 507 AE / J			
A3 (8P1) 1.4 TFSI (09/07 → 08/12) CAXC; CMSA 92 kW						
2007 → 2008			03C 105 209 AK	Z = 23/18; → 30/10/2007	MCK1200	MCK1240
			03C 115 225	56 Maglie/Links; → 30/10/2007		
			03C 109 507 AF			
2007 → 2008			03C 105 209 AC / BE	Z = 18/18; 30/10/2007 →	MCK0580	MCK1240
			03C 115 230 C	54 Maglie/Links; 30/10/2007 →		
			03C 109 507 AE / J			
2007 → 2008			03C 105 209 AM / BE	Z = 18/18	MCK0580	MCK1240
			03C 115 230 C	54 Maglie/Links; → 30/10/2007		
			03C 109 507 AE / J			
2008 → 2012			03C 105 209 AC / BE	Z = 18/18; → 21/07/2008	MCK0580	MCK1240
			03C 115 230 C	54 Maglie/Links; → 21/07/2008		
			03C 109 507 AE / J			
			03C 105 209 AQ	Z = 18/18; 21/07/2008 →		
			03C 115 225 A	54 Maglie/Links; 21/07/2008 →		
			03C 109 507 AD		MCK1210	MCK1240

**MAGNETI
MARELLI**

PARTS & SERVICES

		PARTS	OE			COMPLETE KIT	EASY KIT
AUDI							
A3 Sportback (8PA) 1.4 TFSI (09/07 → 03/13) CAXC; CMSA 92 kW							
2007 → 2008			03C 105 209 AK	Z = 23/18; → 30/10/2007	MCK1200	MCK1240	
			03C 115 225	56 Maglie/Links; → 30/10/2007			
			03C 109 507 AF				
			03C 105 209 AC / BE	Z = 18/18; 30/10/2007 →	MCK0580	MCK1240	
			03C 115 230 C	54 Maglie/Links; 30/10/2007 →			
			03C 109 507 AE / J				
		03C 105 209 AM / BE	Z = 18/18	MCK0580	MCK1240		
		03C 115 230 C	54 Maglie/Links; → 30/10/2007				
		03C 109 507 AE / J					
2009 → 2013			03C 105 209 AC / BE	Z = 18/18; → 21/07/2008	MCK0580	MCK1240	
			03C 115 230 C	54 Maglie/Links; → 21/07/2008			
			03C 109 507 AE / J				
			03C 105 209 AQ	Z = 18/18; 21/07/2008 →	MCK1210	MCK1240	
			03C 115 225 A	54 Maglie/Links; 21/07/2008 →			
			03C 109 507 AD				
A3 Cabriolet (8P7) 1.4 TFSI (02/11 → 05/13) CAXC 92 kW							
			03C 105 209 AQ / AR	Z = 18/18	MCK1210	MCK1240	
			03C 115 225 A	54 Maglie/Links			
			03C 109 507 AD				
SEAT							
ALHAMBRA (710, 711) 1.4 TSI (06/10 →) CAVA; CNWB; CTHA 110 kW							
2011 → 2015			03C 105 209 AR	Z = 18/18	MCK1210	MCK1240	
			03C 115 225 A	54 Maglie/Links			
			03C 109 507 AD				
ALTEA (5P1) 1.4 TSI (11/07 →) CAXC 92 kW							
2007 → 2010			03C 105 209 AC / BE	Z = 18/18; → 1P-9-023 795	MCK0580	MCK1240	
			03C 115 230 C	54 Maglie/Links; → 5P-9-011 823			
			03C 109 507 AE / J				
			03C 105 209 AQ	Z = 18/18; 1P-9-023 795 →	MCK1210	MCK1240	
			03C 115 225 A	54 Maglie/Links; 5P-9-011 823 →			
			03C 109 507 AD				
2011 → 2015			03C 105 209 AQ	Z = 18/18	MCK1210	MCK1240	
			03C 115 225 A	54 Maglie/Links			
			03C 109 507 AD				
ALTEA XL (5P5, 5P8) 1.4 TSI (11/07 →) CAXC 92 kW							
2007 → 2010			03C 105 209 AC / BE	Z = 18/18; → 1P-9-023 795	MCK0580	MCK1240	
			03C 115 230 C	54 Maglie/Links; → 5P-9-011 823			
			03C 109 507 AE / J				
			03C 105 209 AQ	Z = 18/18; 1P-9-023 795 →	MCK1210	MCK1240	
			03C 115 225 A	54 Maglie/Links; 5P-9-011 823 →			
			03C 109 507 AD				
2011 → 2015			03C 105 209 AQ	Z = 18/18	MCK1210	MCK1240	
			03C 115 225 A	54 Maglie/Links			
			03C 109 507 AD				
CORDOBA (6L2) 1.6 16V (11/06 → 11/09) BTS 77 kW							
			03C 105 209 AC / BE	Z = 18/18	MCK0580	MCK1240	
			03C 115 230 C	54 Maglie/Links			
			03C 109 507 AE / J				

**MAGNETI
MARELLI**

PARTS & SERVICES

		PARTS	OE		COMPLETE KIT	EASY KIT
SEAT						
IBIZA III (6L1) 1.6 16V (11/06 → 11/09) BTS 77 kW						
			03C 105 209 AC / BE	Z = 18/18	MCK0580	MCK1240
			03C 115 230 C	54 Maglie/Links		
			03C 109 507 AE / J			
IBIZA IV (6J5, 6P1) 1.6 (05/08 → 03/12) BTS 77 kW						
			03C 105 209 AC / BE	Z = 18/18	MCK0580	MCK1240
			03C 115 230 C	54 Maglie/Links		
			03C 109 507 AE / J			
IBIZA IV SPORTCOUPE (6J1, 6P5) 1.6 (07/08 → 05/15) BTS 77 kW						
			03C 105 209 AC / BE	Z = 18/18	MCK0580	MCK1240
			03C 115 230 C	54 Maglie/Links		
			03C 109 507 AE / J			
IBIZA IV (6J5, 6P1), IBIZA IV SPORTCOUPE (6J1, 6P5) 1.4 TSI (01/09 → 05/15) CAVF; CNUB; CTHF; CTJB 110 kW						
			03C 105 209 AG	Z = 23/18	MCK1200	MCK1240
			03C 115 225	56 Maglie/Links		
			03C 109 507 AF			
IBIZA IV SPORTCOUPE (6J1, 6P5) 1.4 TSI Cupra (06/09 → 05/15) CAVE; CTHE; CTJC 132 kW						
			03C 105 209 AG	Z = 23/18	MCK1200	MCK1240
			03C 115 225	56 Maglie/Links		
			03C 109 507 AF			
IBIZA IV (6J5, 6P1); IBIZA IV SPORTCOUPE (6J1, 6P5) 1.6 LPG (05/11 → 05/15) CNKA 60 kW						
			03C 105 209 AC / BE	Z = 18/18	MCK0580	MCK1240
			03C 115 230 C	54 Maglie/Links		
			03C 109 507 AE / J			
IBIZA IV ST (6J8, 6P8) 1.4 TSI (02/12 → 05/15) CAVF; CNUB; CTHF; CTJB 110 kW						
			03C 105 209 AG	Z = 23/18	MCK1200	MCK1240
			03C 115 225	56 Maglie/Links		
			03C 109 507 AF			
LEON (1P1) 1.4 TSI (11/07 → 12/12) CAXC 92 kW						
2007 → 2010			03C 105 209 AC / BE	Z = 18/18; → 1P-9-023 795	MCK0580	MCK1240
			03C 115 230 C	54 Maglie/Links; → 1P-9-023 795		
			03C 109 507 AE / J			
			03C 105 209 AQ	Z = 18/18; 1P-9-023 796 →	MCK1210	MCK1240
			03C 115 225 A	54 Maglie/Links; 1P-9-023 796 →		
			03C 109 507 AD			
2011 → 2012			03C 105 209 AQ	Z = 18/18	MCK1210	MCK1240
			03C 115 225 A	54 Maglie/Links		
			03C 109 507 AD			
TOLEDO IV (KG3) 1.4 TSI (07/12 → 06/15) CAXA 90 kW						
			03C 105 209 AQ	Z = 18/18	MCK1210	MCK1240
			03C 115 225 A	54 Maglie/Links		
			03C 109 507 AD			
TOLEDO IV (KG3) 1.6 (07/13 → 06/15) CFNA 77 kW						
			03C 105 209 AC / BE	Z = 18/18	MCK0580	MCK1240
			03C 115 230 C	54 Maglie/Links		
			03C 109 507 AE / J			

**MAGNETI
MARELLI**

PARTS & SERVICES

		PARTS	OE			COMPLETE KIT	EASY KIT
SKODA							
FABIA II (542); FABIA II Combi (545) 1.6 (04/07 → 12/14) BTS; CFNA 77 kW							
			03C 105 209 AC / BE	Z = 18/18			
			03C 115 230 C	54 Maglie/Links	MCK0580	MCK1240	
			03C 109 507 AE / J				
FABIA II (542); FABIA II Combi (545) 1.4 TSI RS (05/10 → 12/14) CAVE; CTHE 132 kW							
			03C 105 209 AG	Z = 23/18			
			03C 115 225	56 Maglie/Links	MCK1200	MCK1240	
			03C 109 507 AF				
OCTAVIA II (1Z3); OCTAVIA II Combi (1Z5) 1.6 FSI (02/04 → 10/08) BLF 85 kW							
			03C 105 209 AC / BE	Z = 18/18			
			03C 115 230 C	54 Maglie/Links	MCK0580	MCK1240	
			03C 109 507 AE / J				
OCTAVIA II (1Z3); OCTAVIA II Combi (1Z5) 1.4 TSI (11/08 → 06/13) CAXA 90 kW							
			03C 105 209 AQ	Z = 18/18; → 11/05/2015			
			03C 115 225 A	54 Maglie/Links	MCK1210	MCK1240	
			03C 109 507 AD				
			03C 105 209 BD	Z = 19/18; 11/05/2015 →			
			03C 115 225 A	54 Maglie/Links	MCK1220	MCK1250	
			03C 109 507 AD				
RAPID (NH3); RAPID Spaceback (NH1) 1.4 TSI (07/12 → 06/15) CAXA 90 kW							
			03C 105 209 AQ	Z = 18/18; → 11/05/2015			
			03C 115 225 A	54 Maglie/Links	MCK1210	MCK1240	
			03C 109 507 AD				
			03C 105 209 BD	Z = 19/18; 11/05/2015 →			
			03C 115 225 A	54 Maglie/Links	MCK1220	MCK1250	
			03C 109 507 AD				
RAPID (NH3); RAPID Spaceback (NH1) 1.6 (07/12 → 06/15) CFNA 77 kW							
			03C 105 209 AC / BE	Z = 18/18			
			03C 115 230 C	54 Maglie/Links	MCK0580	MCK1240	
			03C 109 507 AE / J				
ROOMSTER (5J7) 1.6 (09/06 → 05/15) BTS; CFNA 77 kW							
			03C 105 209 AC / BE	Z = 18/18			
			03C 115 230 C	54 Maglie/Links	MCK0580	MCK1240	
			03C 109 507 AE / J				
ROOMSTER (5J7) 1.6 LPG (06/06 → 07/10) BTS 77 kW							
			03C 105 209 AC / BE	Z = 18/18			
			03C 115 230 C	54 Maglie/Links	MCK0580	MCK1240	
			03C 109 507 AE / J				
SUPERB II (3T4); SUPERB II Station wagon (3T5) 1.4 TSI (07/08 → 05/15) CAXC 92 kW							
2008 → 2013			03C 105 209 AQ	Z = 18/18; → 11/05/2015			
			03C 115 225 A	54 Maglie/Links; 01/08/2008 →	MCK1210	MCK1240	
			03C 109 507 AD				
			03C 105 209 BD	Z = 19/18; 11/05/2015 →			
			03C 115 225 A	54 Maglie/Links	MCK1220	MCK1250	
			03C 109 507 AD				

**MAGNETI
MARELLI**

PARTS & SERVICES

		PARTS	OE		 COMPLETE KIT EASY KIT	
SKODA						
YETI (5L) 1.4 TSI (06/10 → 05/15) CAXA 90 kW						
			03C 105 209 AQ	Z = 18/18; → 11/05/2015	MCK1210	MCK1240
			03C 115 225 A	54 Maglie/Links		
			03C 109 507 AD			
			03C 105 209 BD	Z = 19/18; 11/05/2015 →	MCK1220	MCK1250
			03C 115 225 A	54 Maglie/Links		
			03C 109 507 AD			
VOLKSWAGEN						
BEETLE (5C1, 5C2; BEETLE Cabriolet (5C7, 5C8) 1.4 TSI (10/11 → 07/16) CAVD; CNWA; CTHD; CTKA 118 kW						
			03C 105 209 AR / AQ	Z = 18/18; → 11/05/2015	MCK1210	MCK1240
			03C 115 225 A	54 Maglie/Links		
			03C 109 507 AD			
			03C 105 209 BD	Z = 19/18; 11/05/2015 →	MCK1220	MCK1250
			03C 115 225 A	54 Maglie/Links		
			03C 109 507 AD			
CC (358) 1.4 TSI (11/11 → 12/16) CTHD 118 kW						
2012 → 2015			03C 105 209 AR / AQ	Z = 18/18; → 24/05/2015	MCK1210	MCK1240
			03C 115 225 A	54 Maglie/Links		
			03C 109 507 AD			
			03C 105 209 BD	Z = 19/18; 25/05/2015 →	MCK1220	MCK1250
			03C 115 225 A	54 Maglie/Links		
			03C 109 507 AD			
CC (358) 1.4 TSI MultiFuel (11/11 → 12/16) CKMA 118 kW						
2012 → 2015			03C 105 209 AR / AQ	Z = 18/18; → 24/05/2015	MCK1210	MCK1240
			03C 115 225	54 Maglie/Links		
			03C 109 507 AD			
			03C 105 209 BD	Z = 19/18; 25/05/2015 →	MCK1220	MCK1250
			03C 115 225A	54 Maglie/Links		
			03C 109 507 AD			
EOS (1F7, 1F8) 1.6 FSI (06/06 → 05/08) BLF 85 kW						
			03C 105 209 AC / BE	Z = 18/18	MCK0580	MCK1240
			03C 115 230 C	54 Maglie/Links		
			03C 109 507 AE / J			
EOS (1F7, 1F8) 1.4 TSI (11/07 → 08/15) CAXA 90 kW						
2007 → 2008			03C 105 209 AC / BE	Z = 18/18	MCK0580	MCK1240
			03C 115 230 C	54 Maglie/Links		
			03C 109 507 AE / J			
2009 → 2011			03C 105 209 AC	Z = 18/18; → 31/07/2008	MCK0580	MCK1240
			03C 115 230 C	54 Maglie/Links; → 31/07/2008		
			03C 109 507 AE / J			
			03C 105 209 AQ	Z = 18/18; 01/08/2008 →	MCK1210	MCK1240
			03C 115 225 A	54 Maglie/Links; 01/08/2008 →		
			03C 109 507 AD			
2012 → 2015			03C 105 209 AR / AQ	Z = 18/18; → 24/05/2015	MCK1210	MCK1240
			03C 115 225 A	54 Maglie/Links		
			03C 109 507 AD			
			03C 105 209 BD	Z = 19/18; 25/05/2015 →	MCK1220	MCK1250
			03C 115 225 A	54 Maglie/Links		
			03C 109 507 AD			

**MAGNETI
MARELLI**

PARTS & SERVICES

		PARTS	OE			COMPLETE KIT	EASY KIT	
VOLKSWAGEN								
EOS (1F7, 1F8) 1.4 TSI → 05/2015 (05/08 → 08/15) CAVD; CTHD 118 kW								
2009 → 2011			03C 105 209 AG	Z = 23/18; → 30/06/2008	MCK1200	MCK1240		
			03C 115 225	56 Maglie/Links; → 30/06/2008				
			03C 109 507 AF					
			03C 105 209 AR / AQ	Z = 18/18; 01/07/2008 →				
			03C 115 225 A	54 Maglie/Links; 01/07/2008 →				
2011 → 2015			03C 109 507 AD		MCK1210	MCK1240		
			03C 105 209 AR / AQ	Z = 18/18; → 24/05/2015				
			03C 115 225 A	54 Maglie/Links				
			03C 109 507 AD					
			03C 105 209 BD	Z = 19/18; 25/05/2015 →				
			03C 115 225 A	54 Maglie/Links	MCK0580	MCK1240		
			03C 109 507 AD					
			03C 105 209 BD	Z = 19/18; 25/05/2015 →				
			03C 115 225 A	54 Maglie/Links				
			03C 109 507 AD					
GOLF PLUS (5M1, 521) 1.6 FSI (12/04 → 05/08) BLF 85 kW								
			03C 105 209 AC / BE	Z = 18/18	MCK0580	MCK1240		
			03C 115 230 C	54 Maglie/Links				
			03C 109 507 AE / J					
GOLF PLUS (5M1, 521) 1.4 FSI (07/05 → 11/06) BLN 66 kW								
			03C 105 209 AC / BE	Z = 18/18	MCK0580	MCK1240		
			03C 115 230 C	54 Maglie/Links				
			03C 109 507 AE / J					
GOLF PLUS (5M1, 521) 1.4 TSI (05/06 → 06/08) BMY; BLG 103; 125 kW								
			03C 105 209 AG	Z = 23/18	MCK1200	MCK1240		
			03C 115 225	56 Maglie/Links				
			03C 109 507 AF					
GOLF PLUS (5M1, 521) 1.4 TSI (06/07 → 12/13) CAXA 90 kW								
2008 → 2009			03C 105 209 AK / AG	Z = 23/18; → 1K-8-546 000	MCK1200	MCK1240		
			03C 115 225	56 Maglie/Links; → 1K-8-546 000				
			03C 109 507 AF					
			03C 105 209 AC / BE	Z = 18/18; 1K-8-546 001 → 1K-9-825 000	MCK0580	MCK1240		
			03C 115 230 C	54 Maglie/Links; 1K-8-546 001 → 1K-9-825 000				
			03C 109 507 AE / J					
			03C 105 209 AQ	Z = 18/18; 1K-9-825 001 →	MCK1210	MCK1240		
			03C 115 225 A	54 Maglie/Links; 1K-9-825 001 →				
			03C 109 507 AD					
			03C 105 209 AC / BE	Z = 18/18; → 1K-9-825 000	MCK0580	MCK1240		
			03C 115 230 C	→ 1K-9-825 000				
			03C 109 507 AE / J					
			03C 105 209 AQ	Z = 18/18; 1K-9-825 001 →	MCK1210	MCK1240		
			03C 115 225 A	1K-9-825 001 →				
			03C 109 507 AD					
	2009 → 2013			03C 105 209 AQ	Z = 18/18	MCK1210	MCK1240	
				03C 115 225 A	54 Maglie/Links			
				03C 109 507 AD				
	GOLF PLUS (5M1, 521) 1.4 TSI (06/08 → 12/13) CAVD; CNWA; CTHD 118 kW							
				03C 105 209 AR / AQ	Z = 18/18	MCK1210	MCK1240	
			03C 115 225 A	54 Maglie/Links				
			03C 109 507 AD					

**MAGNETI
MARELLI**

PARTS & SERVICES

		PARTS	OE			COMPLETE KIT	EASY KIT
VOLKSWAGEN							
GOLF V (1K1) 1.4 FSI (10/03 → 07/06) BKG; BLN 66 kW							
			03C 105 209 AC / BE	Z = 18/18	MCK0580	MCK1240	
			03C 115 230 C	54 Maglie/Links			
			03C 109 507 AE / J				
GOLF V (1K1) 1.6 FSI (10/03 → 07/08) BAG; BLF; BLP 85 kW							
			03C 105 209 AC / BE	Z = 18/18	MCK0580	MCK1240	
			03C 115 230 C	54 Maglie/Links			
			03C 109 507 AE / J				
GOLF V (1K1) 1.4 TSI (05/07 → 11/08) CAXA 90 kW							
			03C 105 209 AK / AG	Z = 23/18; → 1K-8P050 000, → 1K-8U010 000, → 1K-8W150 000	MCK1200	MCK1240	
			03C 115 225	56 Maglie/Links			
			03C 109 507 AF				
				03C 105 209 AC / BE	Z = 18/18; 1K-8P050 001 →, → 1K-9P025 000, 1K-8U010 001 →, → 1K-9U008 000, 1K-8W150 001 →, → 1K-9W090 000	MCK0580	MCK1240
				03C 115 230 C	54 Maglie/Links		
				03C 109 507 AE / J			
			03C 105 209 AQ	Z = 18/18; 1K-9P025 001 →, 1K-9U008 001 →, 1K-9W090 001 →	MCK1210	MCK1240	
			03C 115 225 A	54 Maglie/Links			
			03C 109 507 AD				
			03C 105 209 AC / BE	Z = 18/18; → 1K-9P025 000, → 1K-9U008 000, → 1K-9W090 000	MCK0580	MCK1240	
			03C 115 230 C	54 Maglie/Links			
			03C 109 507 AE / J				
			03C 105 209 AQ	Z = 18/18; 1K-9P025 001 →, 1K-9U008 001 →, 1K-9W090 001 →	MCK1210	MCK1240	
			03C 115 225 A	54 Maglie/Links			
			03C 109 507 AD				
GOLF V Variant (1K5) 1.4 TSI (06/07 → 07/09) CAXA 90 kW							
			03C 105 209 AK / AG	Z = 23/18; → 31/10/2007	MCK1200	MCK1240	
			03C 115 225	56 Maglie/Links			
			03C 109 507 AF				
				03C 105 209 AC / BE	Z = 18/18; 01/11/2007 → 31/07/2008	MCK0580	MCK1240
				03C 115 230 C	54 Maglie/Links		
				03C 109 507 AE / J			
				03C 105 209 AQ	Z = 18/18; 01/08/2008 → 31/06/2009		
			03C 115 225 A	54 Maglie/Links	MCK1210	MCK1240	
			03C 109 507 AD				

**MAGNETI
MARELLI**

PARTS & SERVICES

		PARTS	OE			COMPLETE KIT	EASY KIT
VOLKSWAGEN							
GOLF VI (5K1) 1.4 TSI (10/08 → 11/12) CAXA 90 kW							
2008 → 2009			03C 105 209 AK / AG	Z = 23/18; → 1K-8P050 000, → 1K-8U010 000, → 1K-8W150 000	MCK1200	MCK1240	
			03C 115 225	56 Maglie/Links			
			03C 109 507 AF				
			03C 105 209 AC / BE	Z = 18/18; 1K-8P050 001 →, → 1K-9P025 000, 1K-8U010 001 →, → 1K-9U008 000, 1K-8W150 001 →, → 1K-9W090 000	MCK0580	MCK1240	
			03C 115 230 C	54 Maglie/Links			
			03C 109 507 AE / J				
			03C 105 209 AQ	Z = 18/18; 1K-9P025 001 →, 1K-9U008 001 →, 1K-9W090 001 →	MCK1210	MCK1240	
			03C 115 225 A	54 Maglie/Links			
			03C 109 507 AD				
			03C 105 209 AC / BE	Z = 18/18; → 1K-9P025 000, → 1K-9U008 000, → 1K-9W090 000	MCK0580	MCK1240	
			03C 115 230 C	54 Maglie/Links			
			03C 109 507 AE / J				
		03C 105 209 AQ	Z = 18/18; 1K-9P025 001 →, 1K-9U008 001 →, 1K-9W090 001 →	MCK1210	MCK1240		
		03C 115 225 A	54 Maglie/Links				
		03C 109 507 AD					
2009 → 2012		03C 105 209 AQ	Z = 18/18	MCK1210	MCK1240		
		03C 115 225 A	54 Maglie/Links				
		03C 109 507 AD					
GOLF VI (5K1) 1.4 TSI (10/08 → 11/12) CAVD; CNWA; CTHD 118 kW							
		03C 105 209 AQ / AR	Z = 18/18	MCK1210	MCK1240		
		03C 115 225 A	54 Maglie/Links				
		03C 109 507 AD					
GOLF VI Cabriolet (517) 1.4 TSI (03/11 → 05/16) CAVD; CNWA; CTHD; CTKA 118 kW							
		03C 105 209 AR / AQ	Z = 18/18; → 24/05/2015	MCK1210	MCK1240		
		03C 115 225 A	54 Maglie/Links				
		03C 109 507 AD					
		03C 105 209 BD	Z = 19/18; 25/05/2015 →				
		03C 115 225 A	54 Maglie/Links	MCK1220	MCK1250		
		03C 109 507 AD					
GOLF VI Cabriolet (517) 1.4 TSI (11/11 → 05/16) CAXA 90 kW							
		03C 105 209 AR / AQ	Z = 18/18; → 24/05/2015	MCK1210	MCK1240		
		03C 115 225 A	54 Maglie/Links				
		03C 109 507 AD					
		03C 105 209 BD	Z = 19/18; 25/05/2015 →				
		03C 115 225 A	54 Maglie/Links	MCK1220	MCK1250		
		03C 109 507 AD					
JETTA III (1K2) 1.6 FSI (09/05 → 10/10) BLF 85 kW							
		03C 105 209 AC / BE	Z = 18/18	MCK0580	MCK1240		
		03C 115 230 C	54 Maglie/Links				
		03C 109 507 AE / J					
JETTA III (1K2) 1.4 TSI (07/06 → 10/10) BMY; BLG 103; 125 kW							
		03C 105 209 AG	Z = 23/18	MCK1200	MCK1240		
		03C 115 225	56 Maglie/Links				
		03C 109 507 AF					

**MAGNETI
MARELLI**

PARTS & SERVICES

		PARTS	OE			
					COMPLETE KIT	EASY KIT
VOLKSWAGEN						
JETTA III (1K2) 1.4 TSI (05/07 → 10/10) CAXA 90 kW						
2007 → 2008			03C 105 209 AK / AG	Z = 23/18	MCK1200	MCK1240
			03C 115 225	56 Maglie/Links		
			03C 109 507 AF			
2007 → 2008			03C 105 209 AC / BE	Z = 18/18	MCK0580	MCK1240
			03C 115 230 C	54 Maglie/Links		
			03C 109 507 AE / J			
2009 → 2010			03C 105 209 AC	Z = 18/18; → 31/07/2008	MCK0580	MCK1240
			03C 115 230 C	54 Maglie/Links		
			03C 109 507 AE / J			
			03C 105 209 AQ	Z = 18/18; 01/08/2008 →		
			03C 115 225 A	54 Maglie/Links		
2009 → 2010			03C 109 507 AD		MCK1210	MCK1240
			03C 105 209 AQ / AR	Z = 18/18		
			03C 115 225 A	54 Maglie/Links		
			03C 109 507 AD			
			03C 105 209 AR / AQ	Z = 18/18; → 11/05/2015		
2015 → 2018			03C 115 225 A	54 Maglie/Links	MCK1210	MCK1240
			03C 109 507 AD			
			03C 105 209 BD	Z = 19/18; 12/05/2015 →		
			03C 115 225 A	54 Maglie/Links		
			03C 109 507 AD			
JETTA IV (162, 163, AV3, AV2) 1.4 TSI (05/11 →) CAXA; CMSB; CAVA; CTHA; CAVD; CTHD 90; 110; 118 kW						
2011 → 2014			03C 105 209 AQ / AR	Z = 18/18	MCK1210	MCK1240
			03C 115 225 A	54 Maglie/Links		
			03C 109 507 AD			
2015 → 2018			03C 105 209 AR / AQ	Z = 18/18; → 11/05/2015	MCK1210	MCK1240
			03C 115 225 A	54 Maglie/Links		
			03C 109 507 AD			
			03C 105 209 BD	Z = 19/18; 12/05/2015 →		
			03C 115 225 A	54 Maglie/Links		
2015 → 2018			03C 109 507 AD		MCK1220	MCK1250
			03C 105 209 AC / BE	Z = 18/18		
			03C 115 230 C	54 Maglie/Links		
			03C 109 507 AE / J			
			03C 105 209 AC / BE	Z = 18/18		
JETTA IV (162, 163, AV3, AV2) 1.6 (12/11 →) CFNA; CLRA 77 kW						
			03C 105 209 AC / BE	Z = 18/18	MCK0580	MCK1240
			03C 115 230 C	54 Maglie/Links		
			03C 109 507 AE / J			
PASSAT (3C2) 1.6 FSI (03/05 → 06/08) BLF 85 kW						
			03C 105 209 AC / BE	Z 18/18	MCK0580	MCK1240
			03C 115 230 C	54 Maglie/Links		
			03C 109 507 J / AE			
PASSAT (3C2) 1.4 TSI (05/07 → 07/10) CAXA 90 kW						
2007 → 2008			03C 105 209 AK	Z = 23/18; → 3C-8E110 000, → 3C-8P060 000	MCK1200	MCK1240
			03C 115 225	56 Maglie/Links		
			03C 109 507 AB/ AF			
			03C 105 209 AC / BE	Z = 18/18; 3C-8E110 001 →, 3C-8P060 001 →		
			03C 115 230 C	54 Maglie/Links		
2009 → 2010			03C 109 507 AE		MCK0580	MCK1240
			03C 105 209 AC / BE	Z = 18/18; → 31/07/2008		
			03C 115 230 C	54 Maglie/Links		
			03C 109 507 AE			
			03C 105 209 AQ	Z = 18/18; 01/08/2008 →		
2009 → 2010			03C 115 225 A	54 Maglie/Links	MCK1210	MCK1240
			03C 109 507 AD			
			03C 105 209 AG	Z = 23/18		
PASSAT (3C2) 1.4 TSI EcoFuel (01/09 → 07/10) CDGA 110 kW						
			03C 105 209 AG	Z = 23/18	MCK1200	MCK1240
			03C 115 225	56 Maglie/Links		
			03C 109 507 AF			

**MAGNETI
MARELLI**

PARTS & SERVICES

		PARTS	OE			COMPLETE KIT	EASY KIT
VOLKSWAGEN							
*		PASSAT (362) 1.4 TSI (08/10 → 12/14)		CAXA	90 kW		
	2010 → 2011		03C 105 209 AC / BE	Z = 18/18; → 31/07/2008			
			03C 115 230 C	54 Maglie/Links	MCK0580	MCK1240	
			03C 109 507 AE / J				
			03C 105 209 AQ	Z = 18/18; 01/08/2008 →			
			03C 115 225 A	54 Maglie/Links	MCK1210	MCK1240	
			03C 109 507 AD				
	2012 → 2014		03C 105 209 AQ	Z = 18/18			
			03C 115 225 A	54 Maglie/Links	MCK1210	MCK1240	
			03C 109 507 AD				
*		PASSAT (362) 1.4 TSI EcoFuel (08/10 → 12/14)		CDGA	110 kW		
			03C 105 209 AG	Z = 23/18			
			03C 115 225	56 Maglie/Links	MCK1200	MCK1240	
			03C 109 507 AF				
*		PASSAT (362) 1.4 TSI MultiFuel (11/10 → 12/14)		CKMA	118 kW		
			03C 105 209 AG	Z = 23/18			
			03C 115 225	56 Maglie/Links	MCK1200	MCK1240	
			03C 109 507 AF				
*		PASSAT (362) 1.4 TSI (11/12 → 12/14)		CTHD	118 kW		
			03C 105 209 AG	Z = 23/18			
			03C 115 225	56 Maglie/Links	MCK1200	MCK1240	
			03C 109 507 AF				
		PASSAT CC (357) 1.4 TSI MultiFuel (01/11 → 01/12)		CKMA	118 kW		
			03C 105 209 AG	Z = 23/18			
			03C 115 225	56 Maglie/Links	MCK1200	MCK1240	
			03C 109 507 AF				
		PASSAT Variant (3C5) 1.6 FSI (08/05 → 06/08)		BLF	85 kW		
			03C 105 209 AC / BE	Z = 18/18			
			03C 115 230 C	54 Maglie/Links	MCK0580	MCK1240	
			03C 109 507 J / AE				
		PASSAT Variant (3C5) 1.4 TSI (05/07 → 11/10)		CAXA	90 kW		
	2007 → 2008		03C 105 209 AK	Z = 23/18; → 3C-8E110 000, → 3C-8P060 000			
			03C 115 225	56 Maglie/Links	MCK1200	MCK1240	
			03C 109 507 AB/ AF				
			03C 105 209 AC / BE	Z = 18/18; 3C-8E110 001 →, 3C-8P060 001 →			
			03C 115 230 C	54 Maglie/Links	MCK0580	MCK1240	
			03C 109 507 AE				
	2009 → 2010		03C 105 209 AC / BE	Z = 18/18; → 31/07/2008			
			03C 115 230 C	54 Maglie/Links	MCK0580	MCK1240	
			03C 109 507 AE				
			03C 105 209 AQ	Z = 18/18; 01/08/2008 →			
			03C 115 225 A	54 Maglie/Links	MCK1210	MCK1240	
			03C 109 507 AD				
		PASSAT Variant (3C5) 1.4 TSI EcoFuel (01/09 → 11/10)		CDGA	110 kW		
			03C 105 209 AG	Z = 23/18			
			03C 115 225	56 Maglie/Links	MCK1200	MCK1240	
			03C 109 507 AF				

**MAGNETI
MARELLI**

PARTS & SERVICES

		PARTS	OE			COMPLETE KIT	EASY KIT
VOLKSWAGEN							
* PASSAT Variant (365) 1.4 TSI (08/10 → 12/14) CAXA 90 kW							
2010 → 2011			03C 105 209 AC / BE	Z 18/18; → 31/07/2008	MCK0580	MCK1240	
			03C 115 230 C	54 Maglie/Links			
			03C 109 507 AE				
			03C 105 209 AQ	Z = 18/18; 01/08/2008 →			
			03C 115 225 A	54 Maglie/Links			
2011 → 2014			03C 109 507 AD		MCK120	MCK1240	
			03C 105 209 AQ	Z = 18/18; 01/08/2008 →			
			03C 115 225 A	54 Maglie/Links			
* PASSAT Variant (365) 1.4 TSI EcoFuel (08/10 → 12/14) CDGA 110 kW							
			03C 105 209 AG	Z = 23/18	MCK1200	MCK1240	
			03C 115 225	56 Maglie/Links			
			03C 109 507 AF				
* PASSAT Variant (365) 1.4 TSI MultiFuel (11/10 → 12/14) CKMA 118 kW							
			03C 105 209 AG	Z = 23/18	MCK1200	MCK1240	
			03C 115 225	56 Maglie/Links			
			03C 109 507 AF				
* PASSAT Variant (365) 1.4 TSI (11/12 → 12/14) CTHD 118 kW							
			03C 105 209 AG	Z = 23/18	MCK1200	MCK1240	
			03C 115 225	56 Maglie/Links			
			03C 109 507 AF				
POLO (9N_) 1.4 FSI (02/02 → 07/06) AXU 63 kW							
			03C 105 209 AC / BE	Z = 18/18	MCK0580	MCK1240	
			03C 115 230 C	54 Maglie/Links			
			03C 109 507 AE				
POLO (9N_) 1.6 16V (05/06 → 11/09) BTS 77 kW							
			03C 105 209 AC / BE	Z = 18/18	MCK0580	MCK1240	
			03C 115 230 C	54 Maglie/Links			
			03C 109 507 AE				
POLO (6R1, 6C1) 1.4 (6R1) (03/09 → 05/14) ; CLPA 63 kW							
			03C 105 209 AC / BE	Z = 18/18	MCK0580	MCK1240	
			03C 115 230 C	54 Maglie/Links			
			03C 109 507 AE				
POLO (6R1, 6C1) 1.4 GTI (05/10 →) CAVE; CTHE 132 kW							
			03C 105 209 AG	Z = 23/18	MCK1200	MCK1240	
			03C 115 225	56 Maglie/Links			
			03C 109 507 AF				
POLO (6R1, 6C1) 1.6 BiFuel (01/11 →) CNKA 60 kW							
			03C 105 209 AC / BE	Z = 18/18	MCK0580	MCK1240	
			03C 115 230 C	54 Maglie/Links			
			03C 109 507 AE				

**MAGNETI
MARELLI**

PARTS & SERVICES

		PARTS	OE			COMPLETE KIT	EASY KIT
VOLKSWAGEN							
SCIROCCO (137, 138) 1.4 TSI (08/08 → 11/17) CAXA; CMSB 90 kW							
2008 → 2015		03C 105 209 AQ	Z = 18/18			MCK1210	MCK1240
		03C 115 225 A	54 Maglie/Links				
		03C 109 507 AD					
2015 → 2018		03C 105 209 AQ	Z = 18/18; → 24/05/2015			MCK1210	MCK1240
		03C 115 225 A	54 Maglie/Links				
		03C 109 507 AD					
		03C 105 209 BD	Z = 19/18; 25/05/2015 →			MCK1220	MCK1250
		03C 115 225 A	54 Maglie/Links				
		03C 109 507 AD					
SCIROCCO (137, 138) 1.4 TSI (05/08 → 11/17) CAVD; CNWA; CTHD; CTKA 118 kW							
2008 → 2014		03C 105 209 AG	Z = 23/18; → 30/06/2008			MCK1200	MCK1240
		03C 115 225	56 Maglie/Links				
		03C 109 507 AF					
		03C 105 209 AR / AQ	Z = 18/18; 01/07/2008 →			MCK1210	MCK1240
		03C 115 225 A	54 Maglie/Links				
2015 → 2018		03C 105 209 AQ	Z = 18/18; → 24/05/2015			MCK1210	MCK1240
		03C 115 225 A	54 Maglie/Links				
		03C 109 507 AD					
		03C 105 209 BD	Z = 19/18; 25/05/2015 →			MCK1220	MCK1250
		03C 115 225 A	54 Maglie/Links				
		03C 109 507 AD					
SHARAN (7N1, 7N2) 1.4 TSI (05/10 →) CAVA; CNWB; CTHA 110 kW							
2010 → 2016		03C 105 209 AR	Z = 18/18; → 24/05/2015			MCK1210	MCK1240
		03C 115 225 A	54 Maglie/Links				
		03C 109 507 AD					
		03C 105 209 BD	Z = 19/18; 25/05/2015 →			MCK1220	MCK1250
		03C 115 225 A	54 Maglie/Links				
	03C 109 507 AD						
TIGUAN (5N_) 1.4 TSI (08/10 → 07/18) CAXA 90 kW							
2010 → 2011		03C 105 209 AQ	Z = 18/18			MCK1210	MCK1240
		03C 115 225 A	54 Maglie/Links				
		03C 109 507 AD					
2010 → 2011		03C 105 209 AR / AQ	Z = 18/18; → 24/05/2015			MCK1210	MCK1240
		03C 115 225 A	54 Maglie/Links				
		03C 109 507 AD					
		03C 105 209 BD	Z = 19/18; 25/05/2015 →			MCK1220	MCK1250
		03C 115 225 A	54 Maglie/Links				
		03C 109 507 AD					

**MAGNETI
MARELLI**

PARTS & SERVICES

				PARTS	OE				
				COMPLETE KIT	EASY KIT				
VOLKSWAGEN									
TIGUAN (5N_) 1.4 TSI 4motion (09/07 → 07/18) BWK; CAVA; CTHA 110 kW									
2008 → 2011	AWD/4WD		03C 105 209 AG	Z = 23/18; → 02/11/2008	MCK1200	MCK1240			
			03C 115 225	56 Maglie/Links					
			03C 109 507 AF						
				03C 105 209 AR	Z = 18/18; 03/11/2008 →	MCK1210	MCK1240		
				03C 115 225 A	54 Maglie/Links				
				03C 109 507 AD					
2012 → 2018			03C 105 209 AR / AQ	Z = 18/18; → 24/05/2015	MCK1210	MCK1240			
			03C 115 225 A	54 Maglie/Links					
			03C 109 507 AD						
				03C 105 209 BD	Z = 19/18; 25/05/2015 →	MCK1220	MCK1250		
				03C 115 225 A	54 Maglie/Links				
				03C 109 507 AD					
TIGUAN (5N_) 1.4 TSI (05/08 → 07/18) CAVA, CTHA 110 kW									
2008 → 2011	AWD/4WD		03C 105 209 AG	Z = 23/18; → 02/11/2008 (4 motion)	MCK1200	MCK1240			
			03C 115 225	56 Maglie/Links					
			03C 109 507 AF						
	FWD			03C 105 209 AR	Z = 18/18; → 02/11/2008 (Front-wheel drive)	MCK1210	MCK1240		
				03C 115 225 A	54 Maglie/Links				
				03C 109 507 AD					
2012 → 2018			03C 105 209 AR / AQ	Z = 18/18; → 24/05/2015	MCK1210	MCK1240			
			03C 115 225 A	54 Maglie/Links					
			03C 109 507 AD						
				03C 105 209 BD	Z = 19/18; 25/05/2015 →	MCK1220	MCK1250		
				03C 115 225 A	54 Maglie/Links				
				03C 109 507 AD					
TIGUAN (5N_) 1.4 TSI; 1.4 TSI 4motion (05/11 → 07/18) CAVD; CTHD 118 kW									
			03C 105 209 AR / AQ	Z = 18/18; → 24/05/2015	MCK1210	MCK1240			
			03C 115 225 A	54 Maglie/Links					
			03C 109 507 AD						
				03C 105 209 BD	Z = 19/18; 25/05/2015 →	MCK1220	MCK1250		
				03C 115 225 A	54 Maglie/Links				
				03C 109 507 AD					
TOURAN (1T1, 1T2) 1.6 FSI (02/03 → 01/07) BAG; BLF; BLP 85 kW									
			03C 105 209 AC / BE	Z = 18/18	MCK0580	MCK1240			
			03C 115 230 C	56 Maglie/Links					
			03C 109 507 J / AE						
TOURAN (1T1, 1T2) 1.4 TSI (02/06 → 05/10) BMY; CAVC 103 kW									
2006 → 2008			03C 105 209 AF / AG	Z = 23/18	MCK1200	MCK1240			
			03C 115 225	56 Maglie/Links					
			03C 109 507 AF						
2009 → 2010			03C 105 209 AF / AG	Z = 23/18; → 1T-9-150 000	MCK1200	MCK1240			
			03C 115 225	56 Maglie/Links					
			03C 109 507 AF						
				03C 105 209 AR	Z = 18/18; 1T-9-150 001 →	MCK1210	MCK1240		
				03C 115 225 A	54 Maglie/Links				
				03C 109 507 AD					

**MAGNETI
MARELLI**

PARTS & SERVICES

		PARTS	OE			COMPLETE KIT	EASY KIT
VOLKSWAGEN							
TOURAN (1T1, 1T2) 1.4 FSI (11/06 → 05/10) BLG; CAVB 125 kW							
2006 → 2008			03C 105 209 AF / AG	Z = 23/18	MCK1200	MCK1240	
			03C 115 225	56 Maglie/Links			
			03C 109 507 AF				
2009 → 2010			03C 105 209 AF / AG	Z = 23/18; → 1T-9-150 000	MCK1200	MCK1240	
			03C 115 225	56 Maglie/Links			
			03C 109 507 AF				
			03C 105 209 AR	Z = 18/18; 1T-9-150 001 →	MCK1210	MCK1240	
			03C 115 225 A	54 Maglie/Links			
			03C 109 507 AD				
TOURAN (1T1, 1T2) 1.4 TSI EcoFuel (05/09 → 05/10) CDGA 110 kW							
			03C 105 209 AG	Z = 23/18	MCK1200	MCK1240	
			03C 115 225	56 Maglie/Links			
			03C 109 507 AF				
TOURAN (1T3) 1.4 TSI (05/10 → 05/15) CAVC; CTHC 103 kW							
2010			03C 105 209 AF / AG	Z = 23/18; → 1T-9-150 000	MCK1200	MCK1240	
			03C 115 225	56 Maglie/Links			
			03C 109 507 AF				
			03C 105 209 AR	Z = 18/18; 1T-9-150 001 →	MCK1210	MCK1240	
			03C 115 225 A	54 Maglie/Links			
			03C 109 507 AD				
2011 → 2015			03C 105 209 AR	Z = 18/18	MCK1210	MCK1240	
			03C 115 225 A	54 Maglie/Links			
			3C 109 507 AD				
TOURAN (1T3) 1.4 TSI (05/10 → 05/15) CAVB; CTHB 125 kW							
2010			03C 105 209 AF / AG	Z = 23/18; → 1T-9-150 000	MCK1200	MCK1240	
			03C 115 225	56 Maglie/Links			
			03C 109 507 AF				
			03C 105 209 AR	Z = 18/18; 1T-9-150 001 →	MCK1210	MCK1240	
			03C 115 225 A	54 Maglie/Links			
			03C 109 507 AD				
2011 → 2015			03C 105 209 AR	Z = 18/18	MCK1210	MCK1240	
			03C 115 225 A	54 Maglie/Links			
			3C 109 507 AD				
TOURAN (1T3) 1.4 TSI EcoFuel (05/10 → 05/15) CDGA 110 kW							
			03C 105 209 AG	Z = 23/18	MCK1200	MCK1240	
			03C 115 225	56 Maglie/Links			
			03C 109 507 AF				

**MAGNETI
MARELLI**

PARTS & SERVICES

* I veicoli **VOLKSWAGEN PASSAT (362) 1.4 TSI**, prodotti dal 08.2010 - 12.2014 e **VOLKSWAGEN PASSAT Variant (365) 1.4 TSI**, prodotti da 08/2010 a 12/2014, assemblati nel biennio 2010-2011 sono a cavallo del cambio di generazione dalla sesta (B6) alla settima (B7).

Per questo motivo la configurazione pignone-albero motore utilizzata potrebbe essere quella della generazione immediatamente precedente.

Su questi veicoli, come indicato anche sui programmi OE, la scelta del kit catena corretto è legata all'individuazione del mese ed anno di produzione che non sempre è di facile individuazione (essendo differente dall'anno di immatricolazione, invece riportato sul libretto).







Di seguito un'ulteriore tabella delle limitazioni da considerare:

*The vehicles **VOLKSWAGEN PASSAT (362) 1.4 TSI**, produced from 08/2010 to 12/2014 and **VOLKSWAGEN PASSAT Variant (365) 1.4 TSI**, produced from 08/2010 to 12/2014, assembled between the two-years period 2010-2011 are between the generation shift from the sixth (B6) to the seventh (B7).*

For this reason, according to OE programs, the pinion - crankshaft configuration installed could be the previous generation one.

On these vehicles, the choice of the right timing chain kit is connected to the individuation of year and month of production, which is not an easy task (it may differ from the registration year written on vehicle registration document).

Here below an additional limitations table to be considered:

		COMPONENTI COMPONENTS	OE		MAGNETI MARELLI PARTS & SERVICES	
					COMPLETE KIT	EASY KIT
→ 2009 (D>>-MJ 2009)		Pignone Pinion	03C 105 209 AC / BE	Z = 18/18; → 31/07/2008	MCK0580	MCK1240
		Albero a gomiti Crankshaft	03C 105 101 BF/BM			
		Cuscinetto reggispinta Thrust bearing	06B 105 313 D			
		Pignone Pinion	03C 105 209 AQ	Z = 18/18; 01/08/2008 →	MCK1210	MCK1240
		Albero a gomiti Crankshaft	03C 105 101 BF/BM			
		Cuscinetto reggispinta Thrust bearing	06B 105 313 D			
2010 (D-MJ 2010>>>) → 2012		Pignone Pinion	03C 105 209 AQ	Z = 18/18	MCK1210	MCK1240
		Albero a gomiti Crankshaft	03C 105 101 BF/BM			
		Cuscinetto reggispinta Thrust bearing	06B 105 313 D			
2012 →		Pignone Pinion	03C 105 209 AQ	Z = 18/18	MCK1210	MCK1240
		Albero a gomiti Crankshaft	03C 105 101 BM			
		Cuscinetto reggispinta Thrust bearing	06B 105 313 D			

Considerando tutte queste variabili, consigliamo di verificare anche attraverso programmi originali i componenti installati sul veicolo per la corretta individuazione del kit sostituzione trasmissione a catena.

Considering all these different variables, we strongly recommend checking, through OE programs, the components installed on the vehicle, in order to identify the right timing chain replacing kit.



Anni produzione veicolo | Vehicle production years

**MAGNETI
MARELLI**

PARTS & SERVICES

Paraoli in FPM e PTFE

ISTRUZIONI ED ACCORGIMENTI PER LA CORRETTA INSTALLAZIONE

All'interno dei kit catena Magneti Marelli Parts & Services, si possono trovare due tipologie di paraoli: **paraoli in FPM** (Gomma-Caucciù Fluorata) e **paraoli in PTFE** (Politetrafluoretilene).

Tali paraoli differiscono tra loro, oltre che per il materiale costruttivo, anche per le modalità e gli accorgimenti necessari per la loro corretta installazione.

Paraoli in FPM (gomma-caucciù fluorata)

Caratteristiche

- Sono considerati i paraoli "tradizionali".
- Creano una barriera fisica tra l'ambiente interno a contatto con il fluido e l'ambiente esterno.
- Presentano al loro interno una molla in metallo che preme sul labbro interno di tenuta per tutta la circonferenza del paraolio; in questo modo si migliora la tenuta in quanto viene esercitata una elevata pressione.

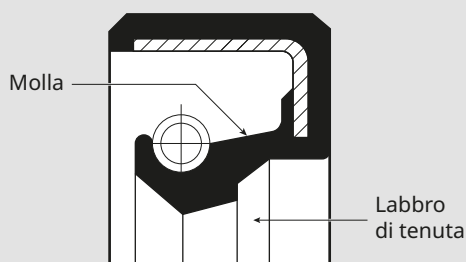

Istruzioni di montaggio

- Verificare i parametri costruttivi (dimensioni e verso di rotazione) e la tipologia di materiale del paraolio da sostituire.
- Rimuovere impurità e sporcizia da tutte le superfici metalliche che entrano a contatto con il paraolio.
- **Non applicare grasso e/o lubrificanti sulla superficie esterna del paraolio e sulla sede.** Se queste superfici vengono contaminate la tenuta esterna viene compromessa al momento del montaggio.
- **Lubrificare con grasso solamente il labbro di tenuta interno del paraolio e la superficie di scorrimento sull'albero.**
- Procedere con il montaggio nella sede con gli appositi utensili. I parametri costruttivi devono essere rivolti verso l'esterno.



La tenuta del paraolio è quasi immediata e il motore può essere acceso anche dopo dieci minuti.

Paraolio in PTFE (politetrafluoretilene)

Caratteristiche

Questi paraoli, nonostante l'assenza della molla di metallo interna, presentano le seguenti peculiarità:

- Maggiore superficie di tenuta a contatto con il metallo che va a migliorare la tenuta.
- Migliore resistenza meccanica alle sollecitazioni anche ad alti regimi di rotazione.
- Migliore resistenza chimica ai lubrificanti con additivi.
- Migliore resistenza alle alte temperature.
- Significativa riduzione delle perdite per attrito.

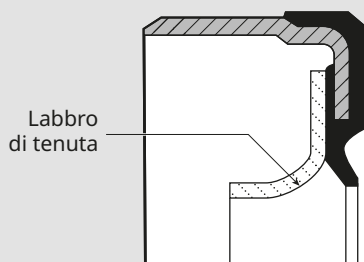

Istruzioni di montaggio



Il montaggio di questi paraoli è differente rispetto l'installazione di un paraolio "tradizionale" in FPM; il labbro interno è protetto da un manicotto in plastica per il mantenimento della forma geometrica e la perfetta adesione all'albero. **Il manicotto deve essere rimosso solo in fase di montaggio del paraolio.**

- Sono necessari degli appositi utensili per il montaggio del paraolio. **Evitare in ogni modo di danneggiare il labbro interno dello stesso.**
- Il montaggio del paraolio in PTFE avviene a secco senza grassi e/o lubrificanti. **Questo paraolio non deve essere mai lubrificato.**
- Verificare i parametri costruttivi (dimensioni e verso di rotazione) e la tipologia di materiale del paraolio da sostituire.
- Rimuovere impurità e sporcizia da tutte le superfici metalliche che entrano a contatto con il paraolio.
- Verificare la superficie dell'albero: non devono essere presenti solchi o altri danni. Eventuali non conformità vanno rimosse.
- Appoggiare l'estremità scanalata del manicotto sull'albero. Inserire il paraolio nella sede facendolo scorrere sul manicotto. Una volta che il paraolio è stato posizionato nella sua sede rimuovere il manicotto.



La tenuta del labbro del paraolio in PTFE non è istantanea. Prima di accendere il motore attendere fino a quattro ore dal montaggio per consentire l'adattamento all'albero e la migliore tenuta del labbro.

Le istruzioni, le raccomandazioni e le informazioni contenute nella presente pubblicazione sono state formulate con la massima cura. Marelli Aftermarket Italy S.p.A., in nome e per conto delle sue affiliate/consociate, non assume responsabilità per alcun tipo di danno anche derivante da errata interpretazione delle informazioni ivi contenute.



MCK0580

VALVE TIMING PROCEDURE

Car brands: **Audi, Volkswagen**

Models: **Audi A3, Volkswagen EOS, Golf V, Golf Plus, Jetta III, Passat VI, Touran**

Engine code: **BAG, BLF, BLG, BLP, BMY**

Power: **1.4 FSI, 1.4 TSI, 1.6 FSI (115, 140, 170 CV)**

Year: **02/2003** →

General precautions

- Always disconnect the ground cable from the battery.
- Remove the spark plugs in order to allow the engine to turn more freely.
- Always turn the engine in the normal direction of rotation (unless specifically instructed otherwise).
- Observe tightening torques.
- If fitted: note the position of the engine shaft position sensor before dismantling.
- **DO NOT** turn the engine shaft by turning the camshaft or other pinions.
- **DO NOT** turn the engine shaft or camshaft with the timing chain removed.

Valve timing procedure

- To dismantle/fit the timing chain it is necessary:
 - To remove the timing cover.
 - To remove the cup.
- ! **Mark the direction of rotation on the chains.**
- Fit the gauge and its support into the spark plug hole for cylinder n. 1. Make sure that the engine is at the TDC of cylinder n. 1 **1**.
- Make sure that the timing marks on the camshaft are aligned as shown **2**. Otherwise, turn the engine shaft 360°.
- Fit the camshaft alignment tool **3**.
- ! **If the camshaft alignment tool cannot be inserted, valve timing is not correct.**
- Press the chain tensioner and block it with the blocking pin **4**.
- Dismantle the camshaft pinion and the chain.
- Align the camshafts. Use the special tool **3**.
- Fit the camshaft pinion and the timing chain.
 - **Engines with variable valve timing:**
Fit a new bolt. Tighten the bolt for the intake camshaft adjustment device **5**. Tightening torque: 40 Nm + 90°.
 - ! **The intake camshaft pinion bolt is reverse threaded.**
 - **Engines without variable valve timing:**
Tighten the intake camshaft pinion bolt **6**. Tightening torque: 50 Nm + 90°.
- Tighten the exhaust camshaft pinion bolt. Tightening torque: 50 Nm + 90°.
- Tighten the engine shaft pulley bolt. Tightening torque **7**:
 - A = 150 Nm + 180°
 - B = 90Nm + 90°.
- ! **The engine shaft pulley bolt and all camshaft pinion bolts MUST be used once only.**
- Dismantle the camshaft alignment tool. Turn the engine shaft clockwise for two turns.
- Check valve timing **3**.

Special equipment

- Display gauge – n. VAS 6079.
- Display gauge support – n. T10170.
- Camshaft alignment tool – n. T10171.
- Camshaft pinion-oil pump blocking tool – n. T10172.
- Engine shaft blocking tool – n. T10340.
- Engine shaft pulley blocking tool – n. 3415.
- Chain tensioner blocking pin – n. T40011.

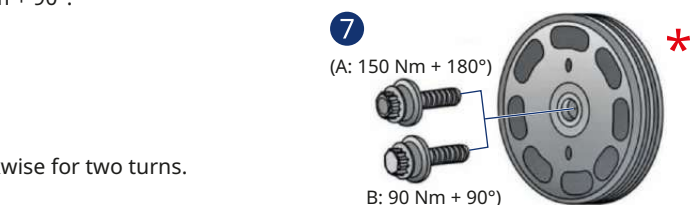
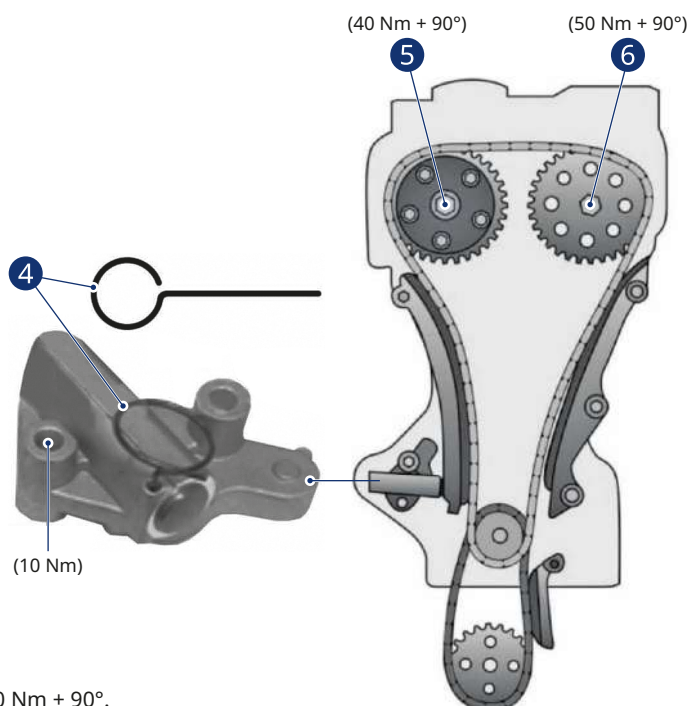
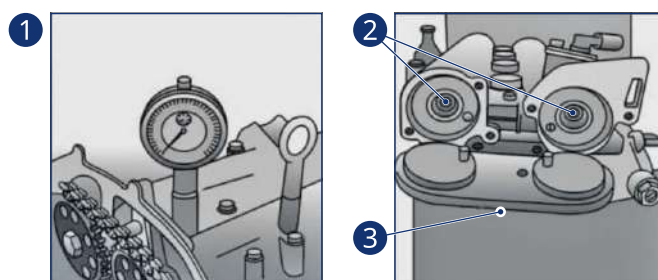

! The chain tensioner contained in this kit is spring-loaded and may cause damage if not handled correctly. **DO NOT** remove the pin until it is completely installed, and always ensure that the piston is pointing away from you or anyone else within a range of 20 metres.

The instructions, the recommendations and the information contained in this publication have been prepared with the utmost attention. Magneti Marelli Aftermarket Italy S.p.A., in the name and on behalf of its affiliates/subsidiaries, does not assume responsibility for any type of damage even deriving from incorrect interpretation of the information therein contained.



* CLARIFICATION ON SCREW TIGHTENING TORQUE

On the Technical bulletin is showed the following information:

- Tighten the engine shaft pulley bolt.
Tightening torque ⑦:

- A = 150 Nm + 180°
- B = 90 Nm + 90°.

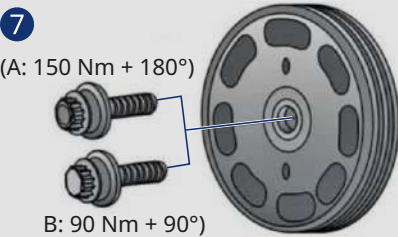

Two tightening torques for a single screw. Which one?

A

If on the vehicle is installed a **combined dodecahedron screw**, with bore headed, resistance/category 10.9, dimensions M14x1,5x100, OE n.: N91048601 like the one showed here below:



Maximum tightening torque must be fixed to: **150 Nm + 180°** (Case A)

B

If on the vehicle is installed a different screw **“without screw head”**, maximum tightening torque must be fixed to **90 Nm + 90°** (Case B)



Motori VW FSI e TFSI

GUIDA ALL'INDIVIDUAZIONE DEL CORRETTO KIT RIPARAZIONE

I motori tipo FSI e TFSI prodotti dal gruppo VW sono caratterizzati da una altissima complessità e variabilità nei componenti che rendono difficoltosa l'individuazione del corretto kit sostituzione della catena distribuzione. Di seguito viene riportato uno schema che, tenendo conto dei componenti installati sul veicolo, aiuta ad individuare il kit da utilizzare.

VW FSI and TFSI engines

CORRECT REPAIRING KIT IDENTIFICATION GUIDE

VW group FSI and TFSI engine-type are characterized by high complexity and components variability which make it difficult the identification of the correct timing chain repairing kit. Here below a scheme which, considering the components installed on the vehicle, helps to identify the right kit to be used.

LEGENDA | SYMBOL LEGEND

PERIODO DI APPLICABILITÀ APPLICABILITY PERIOD	Completo periodo di produzione Whole production period		XXX → XXX Applicabilità da anno ad anno Applicability from year to year		
	Cambio automatico Automatic transmission		Cambio manuale Manual transmission		Direct-Shift Gearbox
	4WD Trazione integrale 4-Wheels Drive		AWD Trazione integrale All-Wheels Drive		FWD Trazione anteriore Front-Wheels Drive
	Pignone Sprocket		Catena Chain		Tenditore Tensioner
TRASMISSIONE TRANSMISSION TYPE	DESCRIZIONE PRODOTTO PARTS DESCRIPTION		CODICE COSTRUTTORE OE REFERENCE		NOTE NOTES
TRAZIONE TRACTION TYPE					Numero telaio Chassis number
					Numero motore Engine number
					→ XXX Fino a XXX To XXX
					XXX → Da XXX From XXX
CODICI MAGNETI MARELLI MAGNETI MARELLI REFERENCES					
A1 (8X1, 8XK) 1.4 TFSI	(05/10 → 04/15)	CAXA; CNVA	90 kW		
Veicolo Vehicle	Anno di produzione Production year	Codice motore Engine code	Potenza motore Engine power		

Le istruzioni, le raccomandazioni e le informazioni contenute nella presente pubblicazione sono state formulate con la massima cura. Marelli Aftermarket Italy S.p.A., in nome e per conto delle sue affiliate/consociate, non assume responsabilità per alcun tipo di danno anche derivante da errata interpretazione delle informazioni ivi contenute.

The instructions, the recommendations and the information contained in this publication have been prepared with the utmost attention. Marelli Aftermarket Italy S.p.A., in the name and on behalf of its affiliates/subsidiaries, does not assume responsibility for any type of damage even deriving from incorrect interpretation of the information therein contained.



		PARTS	OE		COMPLETE KIT	EASY KIT
AUDI						
A1 (8X1, 8XK) 1.4 TFSI (05/10 → 04/15) CAXA; CNVA 90 kW						
			03C 105 209 AQ	Z = 18/18	MCK1210	MCK1240
			03C 115 225 A	54 Maglie/Links		
			03C 109 507 AD			
A1 (8X1, 8XK) 1.4 TFSI (01/11 → 04/15) CAVG; CTHG; CTJA 136 kW						
			03C 105 209 AG	Z = 23/18	MCK1200	MCK1240
			03C 115 225	56 Maglie/Links		
			03C 109 507 AF			
A1 Sportback (8XA, 8XF) 1.4 TFSI (11/11 → 04/15) CAXA; CNVA 90 kW						
			03C 105 209 AQ	Z = 18/18	MCK1210	MCK1240
			03C 115 225 A	54 Maglie/Links		
			03C 109 507 AD			
A1 Sportback (8XA, 8XF) 1.4 TFSI (11/11 → 04/15) CAVG; CTHG; CTJA 136 kW						
			03C 105 209 AG	Z = 23/18	MCK1200	MCK1240
			03C 115 225	56 Maglie/Links		
			03C 109 507 AF			
A3 (8P1) 1.6 FSI (08/03 → 09/07) BAG; BLF; BLP 85 kW						
			03C 105 209 AC / BE	Z = 18/18	MCK0580	MCK1240
			03C 115 230 C	54 Maglie/Links		
			03C 109 507 AE / J			
A3 Sportback (8PA) 1.6 FSI (09/04 → 09/07) BLF; BLP 85 kW						
			03C 105 209 AC / BE	Z = 18/18	MCK0580	MCK1240
			03C 115 230 C	54 Maglie/Links		
			03C 109 507 AE / J			
A3 (8P1) 1.4 TFSI (09/07 → 08/12) CAXC; CMSA 92 kW						
2007 → 2008			03C 105 209 AK	Z = 23/18; → 30/10/2007	MCK1200	MCK1240
			03C 115 225	56 Maglie/Links; → 30/10/2007		
			03C 109 507 AF			
2007 → 2008			03C 105 209 AC / BE	Z = 18/18; 30/10/2007 →	MCK0580	MCK1240
			03C 115 230 C	54 Maglie/Links; 30/10/2007 →		
			03C 109 507 AE / J			
2007 → 2008			03C 105 209 AM / BE	Z = 18/18	MCK0580	MCK1240
			03C 115 230 C	54 Maglie/Links; → 30/10/2007		
			03C 109 507 AE / J			
2008 → 2012			03C 105 209 AC / BE	Z = 18/18; → 21/07/2008	MCK0580	MCK1240
			03C 115 230 C	54 Maglie/Links; → 21/07/2008		
			03C 109 507 AE / J			
			03C 105 209 AQ	Z = 18/18; 21/07/2008 →		
			03C 115 225 A	54 Maglie/Links; 21/07/2008 →		
			03C 109 507 AD		MCK1210	MCK1240



		PARTS	OE		MAGNETI MARELLI PARTS & SERVICES	
					COMPLETE KIT	EASY KIT
AUDI						
A3 Sportback (8PA) 1.4 TFSI (09/07 → 03/13) CAXC; CMSA 92 kW						
2007 → 2008			03C 105 209 AK	Z = 23/18; → 30/10/2007	MCK1200	MCK1240
			03C 115 225	56 Maglie/Links; → 30/10/2007		
			03C 109 507 AF			
			03C 105 209 AC / BE	Z = 18/18; 30/10/2007 →	MCK0580	MCK1240
			03C 115 230 C	54 Maglie/Links; 30/10/2007 →		
			03C 105 209 AM / BE	Z = 18/18	MCK0580	MCK1240
		03C 115 230 C	54 Maglie/Links; → 30/10/2007			
2009 → 2013			03C 105 209 AC / BE	Z = 18/18; → 21/07/2008	MCK0580	MCK1240
			03C 115 230 C	54 Maglie/Links; → 21/07/2008		
			03C 109 507 AE / J			
			03C 105 209 AQ	Z = 18/18; 21/07/2008 →	MCK1210	MCK1240
			03C 115 225 A	54 Maglie/Links; 21/07/2008 →		
			03C 109 507 AD			
A3 Cabriolet (8P7) 1.4 TFSI (02/11 → 05/13) CAXC 92 kW						
			03C 105 209 AQ / AR	Z = 18/18	MCK1210	MCK1240
			03C 115 225 A	54 Maglie/Links		
			03C 109 507 AD			
SEAT						
ALHAMBRA (710, 711) 1.4 TSI (06/10 →) CAVA; CNWB; CTHA 110 kW						
2011 → 2015			03C 105 209 AR	Z = 18/18	MCK1210	MCK1240
			03C 115 225 A	54 Maglie/Links		
			03C 109 507 AD			
ALTEA (5P1) 1.4 TSI (11/07 →) CAXC 92 kW						
2007 → 2010			03C 105 209 AC / BE	Z = 18/18; → 1P-9-023 795	MCK0580	MCK1240
			03C 115 230 C	54 Maglie/Links; → 5P-9-011 823		
			03C 109 507 AE / J			
			03C 105 209 AQ	Z = 18/18; 1P-9-023 795 →	MCK1210	MCK1240
			03C 115 225 A	54 Maglie/Links; 5P-9-011 823 →		
			03C 109 507 AD			
2011 → 2015			03C 105 209 AQ	Z = 18/18	MCK1210	MCK1240
			03C 115 225 A	54 Maglie/Links		
			03C 109 507 AD			
ALTEA XL (5P5, 5P8) 1.4 TSI (11/07 →) CAXC 92 kW						
2007 → 2010			03C 105 209 AC / BE	Z = 18/18; → 1P-9-023 795	MCK0580	MCK1240
			03C 115 230 C	54 Maglie/Links; → 5P-9-011 823		
			03C 109 507 AE / J			
			03C 105 209 AQ	Z = 18/18; 1P-9-023 795 →	MCK1210	MCK1240
			03C 115 225 A	54 Maglie/Links; 5P-9-011 823 →		
			03C 109 507 AD			
2011 → 2015			03C 105 209 AQ	Z = 18/18	MCK1210	MCK1240
			03C 115 225 A	54 Maglie/Links		
			03C 109 507 AD			
CORDOBA (6L2) 1.6 16V (11/06 → 11/09) BTS 77 kW						
			03C 105 209 AC / BE	Z = 18/18	MCK0580	MCK1240
			03C 115 230 C	54 Maglie/Links		
			03C 109 507 AE / J			



		PARTS	OE	<i>i</i>	MAGNETI MARELLI PARTS & SERVICES COMPLETE KIT EASY KIT	
SEAT						
IBIZA III (6L1) 1.6 16V (11/06 → 11/09) BTS 77 kW						
			03C 105 209 AC / BE	Z = 18/18	MCK0580	MCK1240
			03C 115 230 C	54 Maglie/Links		
			03C 109 507 AE / J			
IBIZA IV (6J5, 6P1) 1.6 (05/08 → 03/12) BTS 77 kW						
			03C 105 209 AC / BE	Z = 18/18	MCK0580	MCK1240
			03C 115 230 C	54 Maglie/Links		
			03C 109 507 AE / J			
IBIZA IV SPORTCOUPE (6J1, 6P5) 1.6 (07/08 → 05/15) BTS 77 kW						
			03C 105 209 AC / BE	Z = 18/18	MCK0580	MCK1240
			03C 115 230 C	54 Maglie/Links		
			03C 109 507 AE / J			
IBIZA IV (6J5, 6P1), IBIZA IV SPORTCOUPE (6J1, 6P5) 1.4 TSI (01/09 → 05/15) CAVF; CNUB; CTHF; CTJB 110 kW						
			03C 105 209 AG	Z = 23/18	MCK1200	MCK1240
			03C 115 225	56 Maglie/Links		
			03C 109 507 AF			
IBIZA IV SPORTCOUPE (6J1, 6P5) 1.4 TSI Cupra (06/09 → 05/15) CAVE; CTHE; CTJC 132 kW						
			03C 105 209 AG	Z = 23/18	MCK1200	MCK1240
			03C 115 225	56 Maglie/Links		
			03C 109 507 AF			
IBIZA IV (6J5, 6P1); IBIZA IV SPORTCOUPE (6J1, 6P5) 1.6 LPG (05/11 → 05/15) CNKA 60 kW						
			03C 105 209 AC / BE	Z = 18/18	MCK0580	MCK1240
			03C 115 230 C	54 Maglie/Links		
			03C 109 507 AE / J			
IBIZA IV ST (6J8, 6P8) 1.4 TSI (02/12 → 05/15) CAVF; CNUB; CTHF; CTJB 110 kW						
			03C 105 209 AG	Z = 23/18	MCK1200	MCK1240
			03C 115 225	56 Maglie/Links		
			03C 109 507 AF			
LEON (1P1) 1.4 TSI (11/07 → 12/12) CAXC 92 kW						
2007 → 2010			03C 105 209 AC / BE	Z = 18/18; → 1P-9-023 795	MCK0580	MCK1240
			03C 115 230 C	54 Maglie/Links; → 1P-9-023 795		
			03C 109 507 AE / J			
			03C 105 209 AQ	Z = 18/18; 1P-9-023 796 →	MCK1210	MCK1240
			03C 115 225 A	54 Maglie/Links; 1P-9-023 796 →		
			03C 109 507 AD			
2011 → 2012			03C 105 209 AQ	Z = 18/18	MCK1210	MCK1240
			03C 115 225 A	54 Maglie/Links		
			03C 109 507 AD			
TOLEDO IV (KG3) 1.4 TSI (07/12 → 06/15) CAXA 90 kW						
			03C 105 209 AQ	Z = 18/18	MCK1210	MCK1240
			03C 115 225 A	54 Maglie/Links		
			03C 109 507 AD			
TOLEDO IV (KG3) 1.6 (07/13 → 06/15) CFNA 77 kW						
			03C 105 209 AC / BE	Z = 18/18	MCK0580	MCK1240
			03C 115 230 C	54 Maglie/Links		
			03C 109 507 AE / J			



		PARTS	OE			COMPLETE KIT	EASY KIT
SKODA							
FABIA II (542); FABIA II Combi (545) 1.6 (04/07 → 12/14) BTS; CFNA 77 kW							
			03C 105 209 AC / BE	Z = 18/18			
			03C 115 230 C	54 Maglie/Links	MCK0580	MCK1240	
			03C 109 507 AE / J				
FABIA II (542); FABIA II Combi (545) 1.4 TSI RS (05/10 → 12/14) CAVE; CTHE 132 kW							
			03C 105 209 AG	Z = 23/18			
			03C 115 225	56 Maglie/Links	MCK1200	MCK1240	
			03C 109 507 AF				
OCTAVIA II (1Z3); OCTAVIA II Combi (1Z5) 1.6 FSI (02/04 → 10/08) BLF 85 kW							
			03C 105 209 AC / BE	Z = 18/18			
			03C 115 230 C	54 Maglie/Links	MCK0580	MCK1240	
			03C 109 507 AE / J				
OCTAVIA II (1Z3); OCTAVIA II Combi (1Z5) 1.4 TSI (11/08 → 06/13) CAXA 90 kW							
			03C 105 209 AQ	Z = 18/18; → 11/05/2015			
			03C 115 225 A	54 Maglie/Links	MCK1210	MCK1240	
			03C 109 507 AD				
			03C 105 209 BD	Z = 19/18; 11/05/2015 →			
			03C 115 225 A	54 Maglie/Links	MCK1220	MCK1250	
			03C 109 507 AD				
RAPID (NH3); RAPID Spaceback (NH1) 1.4 TSI (07/12 → 06/15) CAXA 90 kW							
			03C 105 209 AQ	Z = 18/18; → 11/05/2015			
			03C 115 225 A	54 Maglie/Links	MCK1210	MCK1240	
			03C 109 507 AD				
			03C 105 209 BD	Z = 19/18; 11/05/2015 →			
			03C 115 225 A	54 Maglie/Links	MCK1220	MCK1250	
			03C 109 507 AD				
RAPID (NH3); RAPID Spaceback (NH1) 1.6 (07/12 → 06/15) CFNA 77 kW							
			03C 105 209 AC / BE	Z = 18/18			
			03C 115 230 C	54 Maglie/Links	MCK0580	MCK1240	
			03C 109 507 AE / J				
ROOMSTER (5J7) 1.6 (09/06 → 05/15) BTS; CFNA 77 kW							
			03C 105 209 AC / BE	Z = 18/18			
			03C 115 230 C	54 Maglie/Links	MCK0580	MCK1240	
			03C 109 507 AE / J				
ROOMSTER (5J7) 1.6 LPG (06/06 → 07/10) BTS 77 kW							
			03C 105 209 AC / BE	Z = 18/18			
			03C 115 230 C	54 Maglie/Links	MCK0580	MCK1240	
			03C 109 507 AE / J				
SUPERB II (3T4); SUPERB II Station wagon (3T5) 1.4 TSI (07/08 → 05/15) CAXC 92 kW							
2008 → 2013			03C 105 209 AQ	Z = 18/18; → 11/05/2015			
			03C 115 225 A	54 Maglie/Links; 01/08/2008 →	MCK1210	MCK1240	
			03C 109 507 AD				
			03C 105 209 BD	Z = 19/18; 11/05/2015 →			
			03C 115 225 A	54 Maglie/Links	MCK1220	MCK1250	
			03C 109 507 AD				



		PARTS		OE				MAGNETI MARELLI PARTS & SERVICES	
								COMPLETE KIT	EASY KIT
SKODA									
YETI (5L) 1.4 TSI (06/10 → 05/15) CAXA 90 kW									
			03C 105 209 AQ	Z = 18/18; → 11/05/2015	MCK1210	MCK1240			
			03C 115 225 A	54 Maglie/Links					
			03C 109 507 AD						
			03C 105 209 BD	Z = 19/18; 11/05/2015 →	MCK1220	MCK1250			
			03C 115 225 A	54 Maglie/Links					
			03C 109 507 AD						
VOLKSWAGEN									
BEETLE (5C1, 5C2; BEETLE Cabriolet (5C7, 5C8) 1.4 TSI (10/11 → 07/16) CAVD; CNWA; CTHD; CTKA 118 kW									
			03C 105 209 AR / AQ	Z = 18/18; → 11/05/2015	MCK1210	MCK1240			
			03C 115 225 A	54 Maglie/Links					
			03C 109 507 AD						
			03C 105 209 BD	Z = 19/18; 11/05/2015 →	MCK1220	MCK1250			
			03C 115 225 A	54 Maglie/Links					
			03C 109 507 AD						
CC (358) 1.4 TSI (11/11 → 12/16) CTHD 118 kW									
2012 → 2015			03C 105 209 AR / AQ	Z = 18/18; → 24/05/2015	MCK1210	MCK1240			
			03C 115 225 A	54 Maglie/Links					
			03C 109 507 AD						
			03C 105 209 BD	Z = 19/18; 25/05/2015 →	MCK1220	MCK1250			
			03C 115 225 A	54 Maglie/Links					
			03C 109 507 AD						
CC (358) 1.4 TSI MultiFuel (11/11 → 12/16) CKMA 118 kW									
2012 → 2015			03C 105 209 AR / AQ	Z = 18/18; → 24/05/2015	MCK1210	MCK1240			
			03C 115 225	54 Maglie/Links					
			03C 109 507 AD						
			03C 105 209 BD	Z = 19/18; 25/05/2015 →	MCK1220	MCK1250			
			03C 115 225A	54 Maglie/Links					
			03C 109 507 AD						
EOS (1F7, 1F8) 1.6 FSI (06/06 → 05/08) BLF 85 kW									
			03C 105 209 AC / BE	Z = 18/18	MCK0580	MCK1240			
			03C 115 230 C	54 Maglie/Links					
			03C 109 507 AE / J						
EOS (1F7, 1F8) 1.4 TSI (11/07 → 08/15) CAXA 90 kW									
2007 → 2008			03C 105 209 AC / BE	Z = 18/18	MCK0580	MCK1240			
			03C 115 230 C	54 Maglie/Links					
			03C 109 507 AE / J						
2009 → 2011			03C 105 209 AC	Z = 18/18; → 31/07/2008	MCK0580	MCK1240			
			03C 115 230 C	54 Maglie/Links; → 31/07/2008					
			03C 109 507 AE / J						
			03C 105 209 AQ	Z = 18/18; 01/08/2008 →	MCK1210	MCK1240			
			03C 115 225 A	54 Maglie/Links; 01/08/2008 →					
			03C 109 507 AD						
2012 → 2015			03C 105 209 AR / AQ	Z = 18/18; → 24/05/2015	MCK1210	MCK1240			
			03C 115 225 A	54 Maglie/Links					
			03C 109 507 AD						
			03C 105 209 BD	Z = 19/18; 25/05/2015 →	MCK1220	MCK1250			
			03C 115 225 A	54 Maglie/Links					
			03C 109 507 AD						



				PARTS	OE			
							COMPLETE KIT	EASY KIT
VOLKSWAGEN								
EOS (1F7, 1F8) 1.4 TSI → 05/2015 (05/08 → 08/15) CAVD; CTHD 118 kW								
2009 → 2011			03C 105 209 AG	Z = 23/18; → 30/06/2008	MCK1200	MCK1240		
			03C 115 225	56 Maglie/Links; → 30/06/2008				
			03C 109 507 AF					
			03C 105 209 AR / AQ	Z = 18/18; 01/07/2008 →				
			03C 115 225 A	54 Maglie/Links; 01/07/2008 →				
2011 → 2015			03C 105 209 AR / AQ	Z = 18/18; → 24/05/2015	MCK0580	MCK1240		
			03C 115 225 A	54 Maglie/Links				
			03C 109 507 AD					
			03C 105 209 BD	Z = 19/18; 25/05/2015 →				
			03C 115 225 A	54 Maglie/Links				
GOLF PLUS (5M1, 521) 1.6 FSI (12/04 → 05/08) BLF 85 kW			03C 105 209 AC / BE	Z = 18/18	MCK0580	MCK1240		
			03C 115 230 C	54 Maglie/Links				
			03C 109 507 AE / J					
GOLF PLUS (5M1, 521) 1.4 FSI (07/05 → 11/06) BLN 66 kW			03C 105 209 AC / BE	Z = 18/18	MCK0580	MCK1240		
			03C 115 230 C	54 Maglie/Links				
			03C 109 507 AE / J					
GOLF PLUS (5M1, 521) 1.4 TSI (05/06 → 06/08) BMY; BLG 103; 125 kW			03C 105 209 AG	Z = 23/18	MCK1200	MCK1240		
			03C 115 225	56 Maglie/Links				
			03C 109 507 AF					
GOLF PLUS (5M1, 521) 1.4 TSI (06/07 → 12/13) CAXA 90 kW	2008 → 2009			03C 105 209 AK / AG	Z = 23/18; → 1K-8-546 000	MCK1200	MCK1240	
				03C 115 225	56 Maglie/Links; → 1K-8-546 000			
				03C 109 507 AF				
			03C 105 209 AC / BE	Z = 18/18; 1K-8-546 001 → 1K-9-825 000	MCK0580	MCK1240		
			03C 115 230 C	54 Maglie/Links; 1K-8-546 001 → 1K-9-825 000				
			03C 109 507 AE / J					
			03C 105 209 AQ	Z = 18/18; 1K-9-825 001 →	MCK1210	MCK1240		
			03C 115 225 A	54 Maglie/Links; 1K-9-825 001 →				
			03C 109 507 AD					
			03C 105 209 AC / BE	Z = 18/18; → 1K-9-825 000	MCK0580	MCK1240		
			03C 115 230 C	→ 1K-9-825 000				
			03C 109 507 AE / J					
			03C 105 209 AQ	Z = 18/18; 1K-9-825 001 →	MCK1210	MCK1240		
			03C 115 225 A	1K-9-825 001 →				
			03C 109 507 AD					
2009 → 2013			03C 105 209 AQ	Z = 18/18	MCK1210	MCK1240		
			03C 115 225 A	54 Maglie/Links				
			03C 109 507 AD					
GOLF PLUS (5M1, 521) 1.4 TSI (06/08 → 12/13) CAVD; CNWA; CTHD 118 kW			03C 105 209 AR / AQ	Z = 18/18	MCK1210	MCK1240		
			03C 115 225 A	54 Maglie/Links				
			03C 109 507 AD					



		PARTS	OE		MAGNETI MARELLI PARTS & SERVICES COMPLETE KIT EASY KIT		
VOLKSWAGEN							
GOLF V (1K1) 1.4 FSI (10/03 → 07/06) BKG; BLN 66 kW							
			03C 105 209 AC / BE	Z = 18/18	MCK0580	MCK1240	
			03C 115 230 C	54 Maglie/Links			
			03C 109 507 AE / J				
GOLF V (1K1) 1.6 FSI (10/03 → 07/08) BAG; BLF; BLP 85 kW							
			03C 105 209 AC / BE	Z = 18/18	MCK0580	MCK1240	
			03C 115 230 C	54 Maglie/Links			
			03C 109 507 AE / J				
GOLF V (1K1) 1.4 TSI (05/07 → 11/08) CAXA 90 kW							
			03C 105 209 AK / AG	Z = 23/18; → 1K-8P050 000, → 1K-8U010 000, → 1K-8W150 000	MCK1200	MCK1240	
			03C 115 225	56 Maglie/Links			
			03C 109 507 AF				
				03C 105 209 AC / BE	Z = 18/18; 1K-8P050 001 →, → 1K-9P025 000, 1K-8U010 001 →, → 1K-9U008 000, 1K-8W150 001 →, → 1K-9W090 000	MCK0580	MCK1240
				03C 115 230 C	54 Maglie/Links		
				03C 109 507 AE / J			
				03C 105 209 AQ	Z = 18/18; 1K-9P025 001 →, 1K-9U008 001 →, 1K-9W090 001 →	MCK1210	MCK1240
				03C 115 225 A	54 Maglie/Links		
				03C 109 507 AD			
				03C 105 209 AC / BE	Z = 18/18; → 1K-9P025 000, → 1K-9U008 000, → 1K-9W090 000	MCK0580	MCK1240
				03C 115 230 C	54 Maglie/Links		
				03C 109 507 AE / J			
				03C 105 209 AQ	Z = 18/18; 1K-9P025 001 →, 1K-9U008 001 →, 1K-9W090 001 →	MCK1210	MCK1240
				03C 115 225 A	54 Maglie/Links		
				03C 109 507 AD			
	GOLF V Variant (1K5) 1.4 TSI (06/07 → 07/09) CAXA 90 kW						
				03C 105 209 AK / AG	Z = 23/18; → 31/10/2007	MCK1200	MCK1240
				03C 115 225	56 Maglie/Links		
			03C 109 507 AF				
				03C 105 209 AC / BE	Z = 18/18; 01/11/2007 → 31/07/2008	MCK0580	MCK1240
				03C 115 230 C	54 Maglie/Links		
				03C 109 507 AE / J			
				03C 105 209 AQ	Z = 18/18; 01/08/2008 → 31/06/2009	MCK1210	MCK1240
				03C 115 225 A	54 Maglie/Links		
				03C 109 507 AD			



**MAGNETI
MARELLI**

PARTS & SERVICES

		PARTS	OE		 COMPLETE KIT EASY KIT	
VOLKSWAGEN						
GOLF VI (5K1) 1.4 TSI (10/08 → 11/12) CAXA 90 kW						
2008 → 2009			03C 105 209 AK / AG	Z = 23/18; → 1K-8P050 000, → 1K-8U010 000, → 1K-8W150 000	MCK1200	MCK1240
			03C 115 225	56 Maglie/Links		
			03C 109 507 AF			
			03C 105 209 AC / BE	Z = 18/18; 1K-8P050 001 →, → 1K-9P025 000, 1K-8U010 001 →, → 1K-9U008 000, 1K-8W150 001 →, → 1K-9W090 000	MCK0580	MCK1240
			03C 115 230 C	54 Maglie/Links		
			03C 109 507 AE / J			
			03C 105 209 AQ	Z = 18/18; 1K-9P025 001 →, 1K-9U008 001 →, 1K-9W090 001 →	MCK1210	MCK1240
			03C 115 225 A	54 Maglie/Links		
			03C 109 507 AD			
			03C 105 209 AC / BE	Z = 18/18; → 1K-9P025 000, → 1K-9U008 000, → 1K-9W090 000	MCK0580	MCK1240
			03C 115 230 C	54 Maglie/Links		
			03C 109 507 AE / J			
			03C 105 209 AQ	Z = 18/18; 1K-9P025 001 →, 1K-9U008 001 →, 1K-9W090 001 →	MCK1210	MCK1240
			03C 115 225 A	54 Maglie/Links		
			03C 109 507 AD			
2009 → 2012		03C 105 209 AQ	Z = 18/18	MCK1210	MCK1240	
		03C 115 225 A	54 Maglie/Links			
		03C 109 507 AD				
GOLF VI (5K1) 1.4 TSI (10/08 → 11/12) CAVD; CNWA; CTHD 118 kW						
		03C 105 209 AQ / AR	Z = 18/18	MCK1210	MCK1240	
		03C 115 225 A	54 Maglie/Links			
		03C 109 507 AD				
GOLF VI Cabriolet (517) 1.4 TSI (03/11 → 05/16) CAVD; CNWA; CTHD; CTKA 118 kW						
		03C 105 209 AR / AQ	Z = 18/18; → 24/05/2015	MCK1210	MCK1240	
		03C 115 225 A	54 Maglie/Links			
		03C 109 507 AD				
		03C 105 209 BD	Z = 19/18; 25/05/2015 →	MCK1220	MCK1250	
		03C 115 225 A	54 Maglie/Links			
	03C 109 507 AD					
GOLF VI Cabriolet (517) 1.4 TSI (11/11 → 05/16) CAXA 90 kW						
		03C 105 209 AR / AQ	Z = 18/18; → 24/05/2015	MCK1210	MCK1240	
		03C 115 225 A	54 Maglie/Links			
		03C 109 507 AD				
		03C 105 209 BD	Z = 19/18; 25/05/2015 →	MCK1220	MCK1250	
		03C 115 225 A	54 Maglie/Links			
	03C 109 507 AD					
JETTA III (1K2) 1.6 FSI (09/05 → 10/10) BLF 85 kW						
		03C 105 209 AC / BE	Z = 18/18	MCK0580	MCK1240	
		03C 115 230 C	54 Maglie/Links			
		03C 109 507 AE / J				
JETTA III (1K2) 1.4 TSI (07/06 → 10/10) BMY; BLG 103; 125 kW						
		03C 105 209 AG	Z = 23/18	MCK1200	MCK1240	
		03C 115 225	56 Maglie/Links			
		03C 109 507 AF				



		PARTS	OE		MAGNETI MARELLI PARTS & SERVICES	
					COMPLETE KIT	EASY KIT
VOLKSWAGEN						
JETTA III (1K2) 1.4 TSI (05/07 → 10/10) CAXA 90 kW						
2007 → 2008			03C 105 209 AK / AG	Z = 23/18	MCK1200	MCK1240
			03C 115 225	56 Maglie/Links		
			03C 109 507 AF			
2007 → 2008			03C 105 209 AC / BE	Z = 18/18	MCK0580	MCK1240
			03C 115 230 C	54 Maglie/Links		
			03C 109 507 AE / J			
2009 → 2010			03C 105 209 AC	Z = 18/18; → 31/07/2008	MCK0580	MCK1240
			03C 115 230 C	54 Maglie/Links		
			03C 109 507 AE / J			
			03C 105 209 AQ	Z = 18/18; 01/08/2008 →		
			03C 115 225 A	54 Maglie/Links		
2009 → 2010			03C 109 507 AD		MCK1210	MCK1240
			03C 105 209 AQ / AR	Z = 18/18		
			03C 115 225 A	54 Maglie/Links		
			03C 109 507 AD			
			03C 105 209 AR / AQ	Z = 18/18; → 11/05/2015		
2015 → 2018			03C 115 225 A	54 Maglie/Links	MCK1210	MCK1240
			03C 109 507 AD			
			03C 105 209 BD	Z = 19/18; 12/05/2015 →		
			03C 115 225 A	54 Maglie/Links		
			03C 109 507 AD			
JETTA IV (162, 163, AV3, AV2) 1.4 TSI (05/11 →) CAXA; CMSB; CAVA; CTHA; CAVD; CTHD 90; 110; 118 kW						
2011 → 2014			03C 105 209 AQ / AR	Z = 18/18	MCK1210	MCK1240
			03C 115 225 A	54 Maglie/Links		
			03C 109 507 AD			
2015 → 2018			03C 105 209 AR / AQ	Z = 18/18; → 11/05/2015	MCK1210	MCK1240
			03C 115 225 A	54 Maglie/Links		
			03C 109 507 AD			
			03C 105 209 BD	Z = 19/18; 12/05/2015 →		
			03C 115 225 A	54 Maglie/Links		
2015 → 2018			03C 109 507 AD		MCK1220	MCK1250
			03C 105 209 AC / BE	Z = 18/18		
			03C 115 230 C	54 Maglie/Links		
			03C 109 507 AE / J			
			03C 105 209 AC / BE	Z = 18/18		
JETTA IV (162, 163, AV3, AV2) 1.6 (12/11 →) CFNA; CLRA 77 kW						
			03C 105 209 AC / BE	Z = 18/18	MCK0580	MCK1240
			03C 115 230 C	54 Maglie/Links		
			03C 109 507 AE / J			
PASSAT (3C2) 1.6 FSI (03/05 → 06/08) BLF 85 kW						
			03C 105 209 AC / BE	Z 18/18	MCK0580	MCK1240
			03C 115 230 C	54 Maglie/Links		
			03C 109 507 J / AE			
PASSAT (3C2) 1.4 TSI (05/07 → 07/10) CAXA 90 kW						
2007 → 2008			03C 105 209 AK	Z = 23/18; → 3C-8E110 000, → 3C-8P060 000	MCK1200	MCK1240
			03C 115 225	56 Maglie/Links		
			03C 109 507 AB/ AF			
			03C 105 209 AC / BE	Z = 18/18; 3C-8E110 001 →, 3C-8P060 001 →		
			03C 115 230 C	54 Maglie/Links		
2009 → 2010			03C 109 507 AE		MCK0580	MCK1240
			03C 105 209 AC / BE	Z = 18/18; → 31/07/2008		
			03C 115 230 C	54 Maglie/Links		
			03C 109 507 AE			
			03C 105 209 AQ	Z = 18/18; 01/08/2008 →		
2009 → 2010			03C 115 225 A	54 Maglie/Links	MCK1210	MCK1240
			03C 109 507 AD			
			03C 109 507 AD			
PASSAT (3C2) 1.4 TSI EcoFuel (01/09 → 07/10) CDGA 110 kW						
			03C 105 209 AG	Z = 23/18	MCK1200	MCK1240
			03C 115 225	56 Maglie/Links		
			03C 109 507 AF			



				PARTS	OE			
							COMPLETE KIT	EASY KIT
VOLKSWAGEN								
* PASSAT (362) 1.4 TSI (08/10 → 12/14) CAXA 90 kW								
2010 → 2011			03C 105 209 AC / BE	Z = 18/18; → 31/07/2008				
			03C 115 230 C	54 Maglie/Links		MCK0580	MCK1240	
			03C 109 507 AE / J					
			03C 105 209 AQ	Z = 18/18; 01/08/2008 →				
			03C 115 225 A	54 Maglie/Links		MCK1210	MCK1240	
2012 → 2014			03C 109 507 AD					
			03C 105 209 AQ	Z = 18/18				
			03C 115 225 A	54 Maglie/Links		MCK1210	MCK1240	
		03C 109 507 AD						
* PASSAT (362) 1.4 TSI EcoFuel (08/10 → 12/14) CDGA 110 kW								
			03C 105 209 AG	Z = 23/18				
			03C 115 225	56 Maglie/Links		MCK1200	MCK1240	
			03C 109 507 AF					
* PASSAT (362) 1.4 TSI MultiFuel (11/10 → 12/14) CKMA 118 kW								
			03C 105 209 AG	Z = 23/18				
			03C 115 225	56 Maglie/Links		MCK1200	MCK1240	
			03C 109 507 AF					
* PASSAT (362) 1.4 TSI (11/12 → 12/14) CTHD 118 kW								
			03C 105 209 AG	Z = 23/18				
			03C 115 225	56 Maglie/Links		MCK1200	MCK1240	
			03C 109 507 AF					
PASSAT CC (357) 1.4 TSI MultiFuel (01/11 → 01/12) CKMA 118 kW								
			03C 105 209 AG	Z = 23/18				
			03C 115 225	56 Maglie/Links		MCK1200	MCK1240	
			03C 109 507 AF					
PASSAT Variant (3C5) 1.6 FSI (08/05 → 06/08) BLF 85 kW								
			03C 105 209 AC / BE	Z = 18/18				
			03C 115 230 C	54 Maglie/Links		MCK0580	MCK1240	
			03C 109 507 J / AE					
PASSAT Variant (3C5) 1.4 TSI (05/07 → 11/10) CAXA 90 kW								
2007 → 2008			03C 105 209 AK	Z = 23/18; → 3C-8E110 000, → 3C-8P060 000				
			03C 115 225	56 Maglie/Links		MCK1200	MCK1240	
			03C 109 507 AB/ AF					
			03C 105 209 AC / BE	Z = 18/18; 3C-8E110 001 →, 3C-8P060 001 →				
			03C 115 230 C	54 Maglie/Links		MCK0580	MCK1240	
2009 → 2010			03C 109 507 AE					
			03C 105 209 AC / BE	Z = 18/18; → 31/07/2008				
			03C 115 230 C	54 Maglie/Links		MCK0580	MCK1240	
			03C 109 507 AE					
			03C 105 209 AQ	Z = 18/18; 01/08/2008 →				
		03C 115 225 A	54 Maglie/Links		MCK1210	MCK1240		
		03C 109 507 AD						
PASSAT Variant (3C5) 1.4 TSI EcoFuel (01/09 → 11/10) CDGA 110 kW								
			03C 105 209 AG	Z = 23/18				
			03C 115 225	56 Maglie/Links		MCK1200	MCK1240	
			03C 109 507 AF					



		PARTS	OE		MAGNETI MARELLI PARTS & SERVICES COMPLETE KIT EASY KIT	
VOLKSWAGEN						
* PASSAT Variant (365) 1.4 TSI (08/10 → 12/14) CAXA 90 kW						
2010 → 2011			03C 105 209 AC / BE	Z 18/18; → 31/07/2008	MCK0580	MCK1240
			03C 115 230 C	54 Maglie/Links		
			03C 109 507 AE			
			03C 105 209 AQ	Z = 18/18; 01/08/2008 →	MCK120	MCK1240
			03C 115 225 A	54 Maglie/Links		
		03C 109 507 AD				
2011 → 2014			03C 105 209 AQ	Z = 18/18; 01/08/2008 →	MCK1210	MCK1240
			03C 115 225 A	54 Maglie/Links		
			03C 109 507 AD			
* PASSAT Variant (365) 1.4 TSI EcoFuel (08/10 → 12/14) CDGA 110 kW						
			03C 105 209 AG	Z = 23/18	MCK1200	MCK1240
			03C 115 225	56 Maglie/Links		
			03C 109 507 AF			
* PASSAT Variant (365) 1.4 TSI MultiFuel (11/10 → 12/14) CKMA 118 kW						
			03C 105 209 AG	Z = 23/18	MCK1200	MCK1240
			03C 115 225	56 Maglie/Links		
			03C 109 507 AF			
* PASSAT Variant (365) 1.4 TSI (11/12 → 12/14) CTHD 118 kW						
			03C 105 209 AG	Z = 23/18	MCK1200	MCK1240
			03C 115 225	56 Maglie/Links		
			03C 109 507 AF			
POLO (9N_) 1.4 FSI (02/02 → 07/06) AXU 63 kW						
			03C 105 209 AC / BE	Z = 18/18	MCK0580	MCK1240
			03C 115 230 C	54 Maglie/Links		
			03C 109 507 AE			
POLO (9N_) 1.6 16V (05/06 → 11/09) BTS 77 kW						
			03C 105 209 AC / BE	Z = 18/18	MCK0580	MCK1240
			03C 115 230 C	54 Maglie/Links		
			03C 109 507 AE			
POLO (6R1, 6C1) 1.4 (6R1) (03/09 → 05/14) ; CLPA 63 kW						
			03C 105 209 AC / BE	Z = 18/18	MCK0580	MCK1240
			03C 115 230 C	54 Maglie/Links		
			03C 109 507 AE			
POLO (6R1, 6C1) 1.4 GTI (05/10 →) CAVE; CTHE 132 kW						
			03C 105 209 AG	Z = 23/18	MCK1200	MCK1240
			03C 115 225	56 Maglie/Links		
			03C 109 507 AF			
POLO (6R1, 6C1) 1.6 BiFuel (01/11 →) CNKA 60 kW						
			03C 105 209 AC / BE	Z = 18/18	MCK0580	MCK1240
			03C 115 230 C	54 Maglie/Links		
			03C 109 507 AE			



				PARTS	OE			
							COMPLETE KIT	EASY KIT
VOLKSWAGEN								
SCIROCCO (137, 138) 1.4 TSI (08/08 → 11/17) CAXA; CMSB 90 kW								
2008 → 2015		03C 105 209 AQ	Z = 18/18	MCK1210	MCK1240			
		03C 115 225 A	54 Maglie/Links					
		03C 109 507 AD						
2015 → 2018		03C 105 209 AQ	Z = 18/18; → 24/05/2015	MCK1210	MCK1240			
		03C 115 225 A	54 Maglie/Links					
		03C 109 507 AD						
		03C 105 209 BD	Z = 19/18; 25/05/2015 →	MCK1220	MCK1250			
		03C 115 225 A	54 Maglie/Links					
		03C 109 507 AD						
SCIROCCO (137, 138) 1.4 TSI (05/08 → 11/17) CAVD; CNWA; CTHD; CTKA 118 kW								
2008 → 2014		03C 105 209 AG	Z = 23/18; → 30/06/2008	MCK1200	MCK1240			
		03C 115 225	56 Maglie/Links					
		03C 109 507 AF						
		03C 105 209 AR / AQ	Z = 18/18; 01/07/2008 →					
		03C 115 225 A	54 Maglie/Links			MCK1210	MCK1240	
2015 → 2018		03C 105 209 AQ	Z = 18/18; → 24/05/2015	MCK1210	MCK1240			
		03C 115 225 A	54 Maglie/Links					
		03C 109 507 AD						
		03C 105 209 BD	Z = 19/18; 25/05/2015 →	MCK1220	MCK1250			
		03C 115 225 A	54 Maglie/Links					
		03C 109 507 AD						
SHARAN (7N1, 7N2) 1.4 TSI (05/10 →) CAVA; CNWB; CTHA 110 kW								
2010 → 2016		03C 105 209 AR	Z = 18/18; → 24/05/2015	MCK1210	MCK1240			
		03C 115 225 A	54 Maglie/Links					
		03C 109 507 AD						
		03C 105 209 BD	Z = 19/18; 25/05/2015 →					
		03C 115 225 A	54 Maglie/Links			MCK1220	MCK1250	
2010 → 2011		03C 105 209 AR / AQ	Z = 18/18; → 24/05/2015	MCK1210	MCK1240			
		03C 115 225 A	54 Maglie/Links					
		03C 109 507 AD						
		03C 105 209 BD	Z = 19/18; 25/05/2015 →	MCK1220	MCK1250			
		03C 115 225 A	54 Maglie/Links					
		03C 109 507 AD						
TIGUAN (5N_) 1.4 TSI (08/10 → 07/18) CAXA 90 kW								
2010 → 2011		03C 105 209 AQ	Z = 18/18	MCK1210	MCK1240			
		03C 115 225 A	54 Maglie/Links					
		03C 109 507 AD						
2010 → 2011		03C 105 209 AR / AQ	Z = 18/18; → 24/05/2015	MCK1210	MCK1240			
		03C 115 225 A	54 Maglie/Links					
		03C 109 507 AD						
		03C 105 209 BD	Z = 19/18; 25/05/2015 →	MCK1220	MCK1250			
		03C 115 225 A	54 Maglie/Links					
		03C 109 507 AD						



				PARTS	OE			
							COMPLETE KIT	EASY KIT
VOLKSWAGEN								
TIGUAN (5N_) 1.4 TSI 4motion (09/07 → 07/18) BWK; CAVA; CTHA 110 kW								
2008 → 2011	AWD/4WD		03C 105 209 AG	Z = 23/18; → 02/11/2008				
			03C 115 225	56 Maglie/Links		MCK1200	MCK1240	
			03C 109 507 AF					
				03C 105 209 AR	Z = 18/18; 03/11/2008 →			
			03C 115 225 A	54 Maglie/Links		MCK1210	MCK1240	
			03C 109 507 AD					
2012 → 2018			03C 105 209 AR / AQ	Z = 18/18; → 24/05/2015				
			03C 115 225 A	54 Maglie/Links		MCK1210	MCK1240	
			03C 109 507 AD					
				03C 105 209 BD	Z = 19/18; 25/05/2015 →			
			03C 115 225 A	54 Maglie/Links		MCK1220	MCK1250	
			03C 109 507 AD					
TIGUAN (5N_) 1.4 TSI (05/08 → 07/18) CAVA, CTHA 110 kW								
2008 → 2011	AWD/4WD		03C 105 209 AG	Z = 23/18; → 02/11/2008 (4 motion)				
			03C 115 225	56 Maglie/Links		MCK1200	MCK1240	
			03C 109 507 AF					
	FWD			03C 105 209 AR	Z = 18/18; → 02/11/2008 (Front-wheel drive)			
			03C 115 225 A	54 Maglie/Links		MCK1210	MCK1240	
			03C 109 507 AD					
2012 → 2018			03C 105 209 AR / AQ	Z = 18/18; → 24/05/2015				
			03C 115 225 A	54 Maglie/Links		MCK1210	MCK1240	
			03C 109 507 AD					
				03C 105 209 BD	Z = 19/18; 25/05/2015 →			
			03C 115 225 A	54 Maglie/Links		MCK1220	MCK1250	
			03C 109 507 AD					
TIGUAN (5N_) 1.4 TSI; 1.4 TSI 4motion (05/11 → 07/18) CAVD; CTHD 118 kW								
			03C 105 209 AR / AQ	Z = 18/18; → 24/05/2015				
			03C 115 225 A	54 Maglie/Links		MCK1210	MCK1240	
			03C 109 507 AD					
				03C 105 209 BD	Z = 19/18; 25/05/2015 →			
			03C 115 225 A	54 Maglie/Links		MCK1220	MCK1250	
			03C 109 507 AD					
TOURAN (1T1, 1T2) 1.6 FSI (02/03 → 01/07) BAG; BLF; BLP 85 kW								
			03C 105 209 AC / BE	Z = 18/18				
			03C 115 230 C	56 Maglie/Links		MCK0580	MCK1240	
			03C 109 507 J / AE					
TOURAN (1T1, 1T2) 1.4 TSI (02/06 → 05/10) BMY; CAVC 103 kW								
2006 → 2008			03C 105 209 AF / AG	Z = 23/18				
			03C 115 225	56 Maglie/Links		MCK1200	MCK1240	
			03C 109 507 AF					
2009 → 2010			03C 105 209 AF / AG	Z = 23/18; → 1T-9-150 000				
			03C 115 225	56 Maglie/Links		MCK1200	MCK1240	
			03C 109 507 AF					
				03C 105 209 AR	Z = 18/18; 1T-9-150 001 →			
			03C 115 225 A	54 Maglie/Links		MCK1210	MCK1240	
			03C 109 507 AD					



			PARTS	OE			
						COMPLETE KIT	EASY KIT
VOLKSWAGEN							
TOURAN (1T1, 1T2) 1.4 FSI (11/06 → 05/10) BLG; CAVB 125 kW							
2006 → 2008			03C 105 209 AF / AG	Z = 23/18	MCK1200	MCK1240	
			03C 115 225	56 Maglie/Links			
			03C 109 507 AF				
2009 → 2010			03C 105 209 AF / AG	Z = 23/18; → 1T-9-150 000	MCK1200	MCK1240	
			03C 115 225	56 Maglie/Links			
			03C 109 507 AF				
			03C 105 209 AR	Z = 18/18; 1T-9-150 001 →	MCK1210	MCK1240	
			03C 115 225 A	54 Maglie/Links			
			03C 109 507 AD				
TOURAN (1T1, 1T2) 1.4 TSI EcoFuel (05/09 → 05/10) CDGA 110 kW							
			03C 105 209 AG	Z = 23/18	MCK1200	MCK1240	
			03C 115 225	56 Maglie/Links			
			03C 109 507 AF				
TOURAN (1T3) 1.4 TSI (05/10 → 05/15) CAVC; CTHC 103 kW							
2010			03C 105 209 AF / AG	Z = 23/18; → 1T-9-150 000	MCK1200	MCK1240	
			03C 115 225	56 Maglie/Links			
			03C 109 507 AF				
			03C 105 209 AR	Z = 18/18; 1T-9-150 001 →	MCK1210	MCK1240	
			03C 115 225 A	54 Maglie/Links			
			03C 109 507 AD				
2011 → 2015			03C 105 209 AR	Z = 18/18	MCK1210	MCK1240	
			03C 115 225 A	54 Maglie/Links			
			3C 109 507 AD				
TOURAN (1T3) 1.4 TSI (05/10 → 05/15) CAVB; CTHB 125 kW							
2010			03C 105 209 AF / AG	Z = 23/18; → 1T-9-150 000	MCK1200	MCK1240	
			03C 115 225	56 Maglie/Links			
			03C 109 507 AF				
			03C 105 209 AR	Z = 18/18; 1T-9-150 001 →	MCK1210	MCK1240	
			03C 115 225 A	54 Maglie/Links			
			03C 109 507 AD				
2011 → 2015			03C 105 209 AR	Z = 18/18	MCK1210	MCK1240	
			03C 115 225 A	54 Maglie/Links			
			3C 109 507 AD				
TOURAN (1T3) 1.4 TSI EcoFuel (05/10 → 05/15) CDGA 110 kW							
			03C 105 209 AG	Z = 23/18	MCK1200	MCK1240	
			03C 115 225	56 Maglie/Links			
			03C 109 507 AF				



* I veicoli **VOLKSWAGEN PASSAT (362) 1.4 TSI**, prodotti dal 08.2010 - 12.2014 e **VOLKSWAGEN PASSAT Variant (365) 1.4 TSI**, prodotti da 08/2010 a 12/2014, assemblati nel biennio 2010-2011 sono a cavallo del cambio di generazione dalla sesta (B6) alla settima (B7).

Per questo motivo la configurazione pignone-albero motore utilizzata potrebbe essere quella della generazione immediatamente precedente.

Su questi veicoli, come indicato anche sui programmi OE, la scelta del kit catena corretto è legata all'individuazione del mese ed anno di produzione che non sempre è di facile individuazione (essendo differente dall'anno di immatricolazione, invece riportato sul libretto).

Di seguito un'ulteriore tabella delle limitazioni da considerare:

*The vehicles **VOLKSWAGEN PASSAT (362) 1.4 TSI**, produced from 08/2010 to 12/2014 and **VOLKSWAGEN PASSAT Variant (365) 1.4 TSI**, produced from 08/2010 to 12/2014, assembled between the two-years period 2010-2011 are between the generation shift from the sixth (B6) to the seventh (B7).*

For this reason, according to OE programs, the pinion - crankshaft configuration installed could be the previous generation one.

On these vehicles, the choice of the right timing chain kit is connected to the individuation of year and month of production, which is not an easy task (it may differ from the registration year written on vehicle registration document).

Here below an additional limitations table to be considered:

		COMPONENTI COMPONENTS	OE		MAGNETI MARELLI PARTS & SERVICES	
					COMPLETE KIT	EASY KIT
→ 2009 (D>>-MJ 2009)		Pignone Pinion	03C 105 209 AC / BE	Z =18/18; → 31/07/2008	MCK0580	MCK1240
		Albero a gomiti Crankshaft	03C 105 101 BF/BM			
		Cuscinetto reggispinta Thrust bearing	06B 105 313 D			
		Pignone Pinion	03C 105 209 AQ	Z =18/18; 01/08/2008 →	MCK1210	MCK1240
		Albero a gomiti Crankshaft	03C 105 101 BF/BM			
		Cuscinetto reggispinta Thrust bearing	06B 105 313 D			
2010 (D-MJ 2010>>>) → 2012		Pignone Pinion	03C 105 209 AQ	Z = 18/18	MCK1210	MCK1240
		Albero a gomiti Crankshaft	03C 105 101 BF/BM			
		Cuscinetto reggispinta Thrust bearing	06B 105 313 D			
2012 →		Pignone Pinion	03C 105 209 AQ	Z = 18/18	MCK1210	MCK1240
		Albero a gomiti Crankshaft	03C 105 101 BM			
		Cuscinetto reggispinta Thrust bearing	06B 105 313 D			

Considerando tutte queste variabili, consigliamo di verificare anche attraverso programmi originali i componenti installati sul veicolo per la corretta individuazione del kit sostituzione trasmissione a catena.

Considering all these different variables, we strongly recommend checking, through OE programs, the components installed on the vehicle, in order to identify the right timing chain replacing kit.



Anni produzione veicolo | Vehicle production years

**MAGNETI
MARELLI**

PARTS & SERVICES

FPM and PTFE oil seals

INSTRUCTIONS AND PRECAUTIONS FOR PROPER INSTALLATION

Magneti Marelli Parts & Services chain kits include two types of oil seal, one in **FPM** (fluorine rubber) and the other in **PTFE** (Polytetrafluoroethylene).

The two oil seals differ not only in terms of the material they are made of, but also in terms of the method for correct installation and relative precautions.

FPM (fluorine rubber) oil seals

Characteristics

- These oil seals are considered to be the "traditional" type.
- They create a physical barrier between the internal environment, in contact with the fluid, and the external environment.
- They have a metal spring inside that applies pressure to the entire circumference of the inner oil seal lip, thus improving tightness.

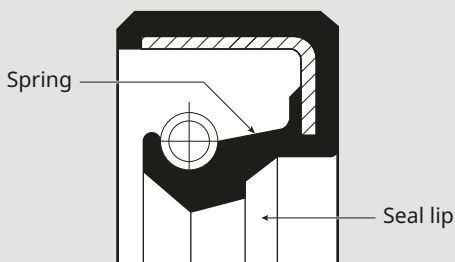

Installation instructions

- Check the seal data (size and direction of rotation) and the type of oil seal material to be replaced.
- Remove any dirt and debris from all metal surfaces that come into contact with the oil seal.
- **Do not apply grease or lubricants to the outer surface of the oil seal or the seal housing.** If these surfaces are contaminated, external sealing will be compromised as soon as the seal is fitted.
- **Apply grease to the inner sealing lip of the oil seal and the sliding surface on the shaft only.**
- Fit the seal into position with the appropriate tools. The side showing the seal data must be facing outwards.



The oil seal is effective almost immediately and the engine can be started after ten minutes.

PTFE (polytetrafluoroethylene) oil seal

Characteristics

Despite the absence of an internal metal spring, these oil seals have the following characteristics:

- Larger sealing surface in contact with the metal, providing increased tightness.
- Improved mechanical resistance to stress even at high rotation speeds.
- Improved chemical resistance to lubricants with additives.
- Improved resistance to high temperatures.
- Significant reduction in leaks due to friction.

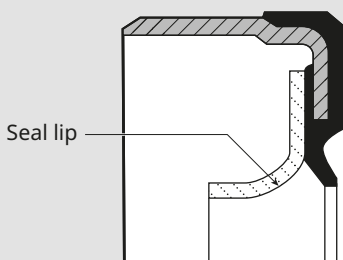

Installation instructions



These oil seals are installed differently from "traditional" oil seals in FPM; the inner lip is protected by a plastic sleeve that maintains the shape of the seal and ensures perfect adhesion to the shaft.
The sleeve must only be removed when installing the oil seal.

- Specific tools are required to install the oil seal. **Do not damage the inner lip of the seal in any way.**
- The PTFE oil seal is to be installed dry, without the use of grease and/or lubricants. **This oil seal must never be lubricated.**
- Check the seal data (size and direction of rotation) and the type of oil seal material to be replaced.
- Remove any dirt and debris from all metal surfaces that come into contact with the oil seal.
- Check the surface of the shaft, ensuring that it is free of grooves or other damage. Any irregularities must be removed.
- Place the grooved end of the sleeve on the shaft. Insert the oil seal into its housing by sliding it along the sleeve. Once the oil seal has been positioned in its housing, remove the sleeve.



The PTFE oil seal is not immediately effective. Allow up to four hours after fitting before starting the engine to allow the seal to adapt to the shaft and achieve full tightness.

The instructions, the recommendations and the information contained in this publication have been prepared with the utmost attention. Magneti Marelli Aftermarket Italy S.p.A., in the name and on behalf of its affiliates/subsidiaries, does not assume responsibility for any type of damage even deriving from incorrect interpretation of the information therein contained.



MCK0580

VENTILSTEUERUNG

Marken: **Audi, Volkswagen**
 Modelle: **Audi A3, Volkswagen EOS, Golf V, Golf Plus, Jetta III, Passat VI, Touran**
 Motorcode: **BAG, BLF, BLG, BLP, BMJ**
 Leistung: **1.4 FSI, 1.4 TSI, 1.6 FSI (115, 140, 170 PS)**
 Baujahr: **02/2003 →**

Allgemeine Vorsichtsmaßnahmen

- Klemmen Sie immer das Massekabel von der Batterie ab.
- Entfernen Sie die Zündkerzen, damit sich der Motor freier drehen kann.
- Drehen Sie den Motor immer in der normalen Drehrichtung (wenn nicht ausdrücklich anders vorgeschrieben).
- Beachten Sie die Anzugsdrehmomente.
- Falls vorhanden: Notieren Sie die Position des Kurbelwellensensors vor der Demontage.
- Drehen Sie die Motorwelle **NICHT** durch Drehen der Nockenwelle oder andere Ritzel.
- Drehen Sie die Motorwelle oder Nockenwelle **NICHT**, wenn die Steuerkette entfernt ist.

Verfahren zur Ventilsteuerung

- Zur Demontage/Montage der Steuerkette ist es notwendig:
 - Den Steuergehäusedeckel zu entfernen.
 - Die Abdeckung zu entfernen.
- ! **Markieren Sie die Laufrichtung an den Ketten.**
- Montieren Sie die Lehre und ihre Halterung in die Zündkerzenbohrung für Zylinder Nr. 1. Stellen Sie sicher, dass der Motor am Totpunkt von Zylinder Nr.1 steht ①.
- Stellen Sie sicher, dass die Steuermarkierungen an der Nockenwelle wie gezeigt ausgerichtet sind ②. Andernfalls drehen Sie die Motorwelle um 360°.
- Montieren Sie das Nockenwellen-Ausrichtungswerkzeug ③.
- ! **Wenn sich das Nockenwellen-Ausrichtungswerkzeug nicht einsetzen lässt, ist die Ventilsteuerung nicht korrekt eingestellt.**
- Drücken Sie den Kettenspanner und blockieren Sie ihn mit dem Blockierstift ④.
- Demontieren Sie das Nockenwellenritzel und die Kette.
- Richten Sie die Nockenwellen aus. Verwenden Sie das Spezialwerkzeug ③.
- Montieren Sie das Nockenwellenritzel und die Steuerkette.
 - **Motoren mit variabler Ventilsteuerung:**
 Montieren Sie eine neue Schraube. Ziehen Sie die Schraube für die Einlassnockenwellen-Verstellvorrichtung an ⑤.
 Anzugsdrehmoment: 40 Nm + 90°.
 - ! **Die Schraube für das Einlassnockenwellenritzel hat ein umgekehrtes Gewinde!**
 - **Motoren ohne variable Ventilsteuerung:**
 Ziehen Sie die Einlassnockenwellen-Ritzelschraube an ⑥. Anzugsdrehmoment: 50 Nm + 90°.
- Ziehen Sie die Auslassnockenwellen-Ritzelschraube an. Anzugsdrehmoment: 50 Nm + 90°.
- Ziehen Sie die Schrauben der Kurbelwellenscheibe an ⑦. Anzugsdrehmoment:
 - A = 150 Nm + 180°
 - B = 90 Nm + 90°.
- ! **Die Schraube für die Kurbelwellenscheibe und alle Schrauben des Nockenwellenritzels dürfen nur EINMAL verwendet werden.**
- Demontieren Sie das Nockenwellen-Ausrichtwerkzeug. Drehen Sie die Motorwelle zwei Umdrehungen lang im Uhrzeigersinn.
- Prüfen Sie die Ventilsteuerung ③.

Spezialwerkzeug

- Anzeigegerät – Nr. VAS 6079.
- Halterung für Anzeigegerät – Nr. T10170.
- Werkzeug zum Ausrichten der Nockenwelle – Nr. T10171.
- Nockenwellenritzel-Ölpumpen-Blockierwerkzeug – Nr. T10172.
- Werkzeug zur Blockierung der Motorwelle – Nr. T10340.
- Werkzeug zum Blockieren der Motorwellenriemenscheibe – Nr. 3415.
- Blockierstift für Kettenspanner – Nr. T40011.

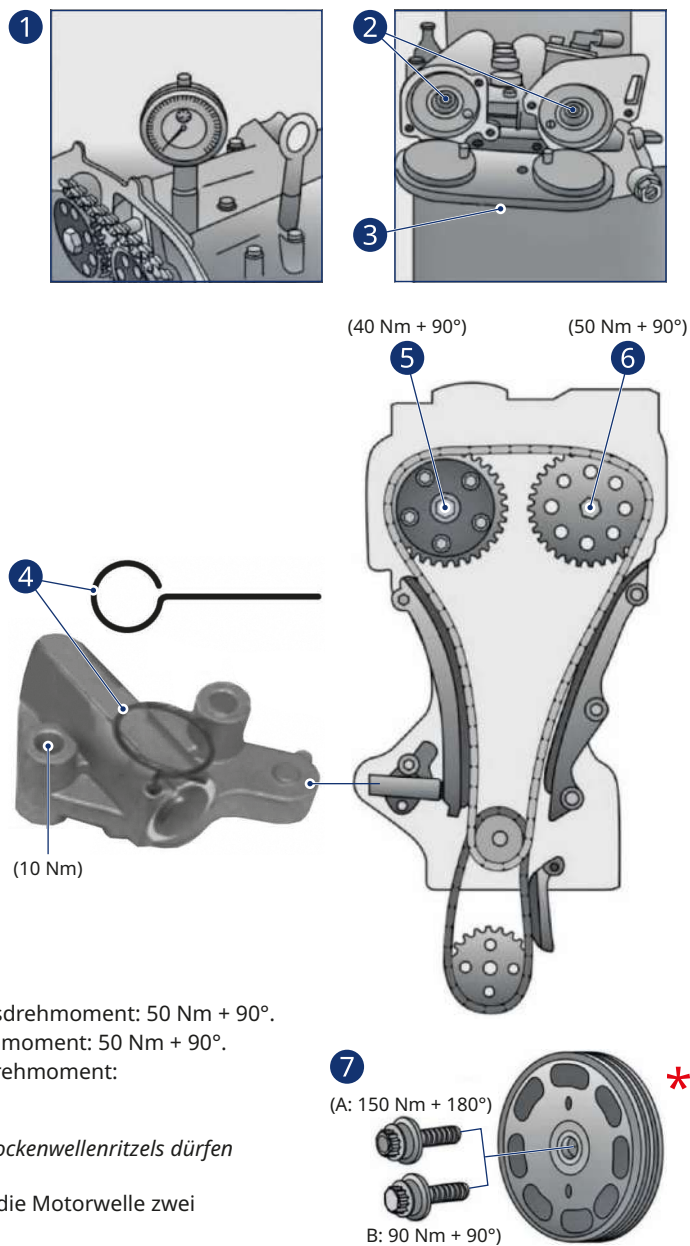

! Der in diesem Kit enthaltene Kettenspanner ist federbelastet und kann bei unsachgemäßer Handhabung Schäden verursachen. Entfernen Sie den Bolzen **NICHT**, bevor dieser vollständig installiert ist, und stellen Sie immer sicher, dass der Kolben von Ihnen oder anderen Personen in einem Umkreis von 20 Metern weg zieht.

Die in dieser Publikation enthaltenen Anweisungen, Empfehlungen und Informationen wurden mit größter Sorgfalt erstellt. Marelli Aftermarket Italy S.p.A. übernimmt im Namen und im Auftrag ihrer Tochtergesellschaften keine Verantwortung für Schäden jeglicher Art, die sich auch aus einer falschen Auslegung der darin enthaltenen Informationen ergeben.

* ERKLÄRUNG ZUM SCHRAUBENANZUGSMOMENT

Auf dem Technischen Merkblatt wird die folgende Information angezeigt:

- Ziehen Sie die Schraube der Antriebswellenriemenscheibe an.
Anzugsdrehmoment ⑦:

- A = 150 Nm + 180°
- B = 90 Nm + 90°.

Zwei Anzugsdrehmomente für eine einzige Schraube. Wann nehme ich was?

A

Wenn am Fahrzeug eine **kombinierte Zwölfkantschraube**, mit Kopfbohrung, Widerstandsfähigkeit/Kategorie 10.9, Abmessungen M14x1,5x100 und laut OE-Nr.: N91048601 installiert ist, dann verfahren Sie wie hier unten gezeigt:



Das maximale Anzugsdrehmoment muss festgelegt werden: **150 Nm + 180°** (Fall A)

B

Wenn am Fahrzeug eine andere Schraube, **„ohne Kopfbohrung“** montiert ist, muss das maximale Anzugsdrehmoment auf **90 Nm + 90°** festgelegt werden (Fall B).



VW FSI- und TFSI-Motoren

ANLEITUNG ZUR KORREKTEN IDENTIFIZIERUNG VON REPARATURSÄTZEN

Die Motoren FSI und TFSI der VW Gruppe sind durch eine hohe Komplexität und Komponenten-Variabilität gekennzeichnet, welche die Identifizierung der richtigen Steuerkette als äußerst schwierig gestaltet. Nachfolgend finden Sie ein Schema, das unter Berücksichtigung der am Fahrzeug verbauten Komponenten hilft, das richtige Kit zu identifizieren.

Moteurs VW FSI et TFSI

GUIDE D'IDENTIFICATION DU BON KIT DE RÉPARATION

Les moteurs de type FSI et TFSI du groupe VW se caractérisent par une grande complexité et une grande variabilité des composants qui rendent difficile l'identification du bon kit de réparation / remplacement de la chaîne de distribution. Ci-dessous, un tableau qui, selon les composants installés sur le véhicule, permet d'identifier le bon kit à utiliser.

LEGENDE | LÉGENDE DES SYMBOLES

ANWENDUNGSZEITRAUM DATE DE PRODUCTION	Kompletter Produktionszeitraum Toute la période de production		XXX → XXX Anwendung von Jahr zu Jahr Fabriqué de année à année	
	Automatikgetriebe Transmission automatique		Schaltgetriebe Transmission manuelle	
			DSG-Getriebe Direct-Shift Gearbox (DSG)	
	4WD 4-Rad Antrieb 4 roues motrices (4x4/4WD)		AWD Allradantrieb Traction intégrale (AWD)	
GETRIEBEART TYPE DE TRANSMISSION	FWD Frontantrieb 2 roues motrices (FWD)			
	Ritzel Pignon		Kettenglieder Chaîne	
ANTRIEBSART TYPE DE TRACTION			Kettenspanner Tendeur	
	PRODUKTBESCHREIBUNG DESCRIPTION DES PIÈCES		OE-REFERENZ RÉFÉRENCE OE	
		HINWEIS INFORMATIONS COMPLÉMENTAIRES		
		Fahrgestellnummer Numéro de châssis		
		Motorcode Numéro de moteur		
		→ XXX Von - Bis XXX À XXX		
		XXX → Ab XXX De XXX		
		TEILENUMMER MAGNETI MARELLI RÉFÉRENCES MAGNETI MARELLI		
PARTS		OE		
A1 (8X1, 8XK) 1.4 TFSI		(05/10 → 04/15)		
90 kW		CAXA; CNVA		
Fahrzeug Modèle		Baujahr Année de production		
Motorcode Code moteur		Leistung Puissance du moteur		

Die in dieser Publikation enthaltenen Anweisungen, Empfehlungen und Informationen wurden mit größter Sorgfalt erstellt. Marelli Aftermarket Italy S.p.A. übernimmt im Namen und im Auftrag ihrer Tochtergesellschaften keine Verantwortung für Schäden jeglicher Art, die sich auch aus einer falschen Auslegung der darin enthaltenen Informationen ergeben.

Les instructions, les recommandations et les informations contenues dans cette publication ont été préparées avec la plus grande attention. Marelli Aftermarket Italy S.p.A., au nom et pour le compte de ses filiales, n'assume aucune responsabilité pour tout type de dommage, même dérivant d'une mauvaise interprétation des informations qui y sont contenues.



		PARTS	OE		COMPLETE KIT	EASY KIT
AUDI						
A1 (8X1, 8XK) 1.4 TFSI (05/10 → 04/15) CAXA; CNVA 90 kW						
			03C 105 209 AQ	Z = 18/18	MCK1210	MCK1240
			03C 115 225 A	54 Kettenglieder/Maillons		
			03C 109 507 AD			
A1 (8X1, 8XK) 1.4 TFSI (01/11 → 04/15) CAVG; CTHG; CTJA 136 kW						
			03C 105 209 AG	Z = 23/18	MCK1200	MCK1240
			03C 115 225	56 Kettenglieder/Maillons		
			03C 109 507 AF			
A1 Sportback (8XA, 8XF) 1.4 TFSI (11/11 → 04/15) CAXA; CNVA 90 kW						
			03C 105 209 AQ	Z = 18/18	MCK1210	MCK1240
			03C 115 225 A	54 Kettenglieder/Maillons		
			03C 109 507 AD			
A1 Sportback (8XA, 8XF) 1.4 TFSI (11/11 → 04/15) CAVG; CTHG; CTJA 136 kW						
			03C 105 209 AG	Z = 23/18	MCK1200	MCK1240
			03C 115 225	56 Kettenglieder/Maillons		
			03C 109 507 AF			
A3 (8P1) 1.6 FSI (08/03 → 09/07) BAG; BLF; BLP 85 kW						
			03C 105 209 AC / BE	Z = 18/18	MCK0580	MCK1240
			03C 115 230 C	54 Kettenglieder/Maillons		
			03C 109 507 AE / J			
A3 Sportback (8PA) 1.6 FSI (09/04 → 09/07) BLF; BLP 85 kW						
			03C 105 209 AC / BE	Z = 18/18	MCK0580	MCK1240
			03C 115 230 C	54 Kettenglieder/Maillons		
			03C 109 507 AE / J			
A3 (8P1) 1.4 TFSI (09/07 → 08/12) CAXC; CMSA 92 kW						
2007 → 2008			03C 105 209 AK	Z = 23/18; → 30/10/2007	MCK1200	MCK1240
			03C 115 225	56 Kettenglieder/Maillons; → 30/10/2007		
			03C 109 507 AF			
			03C 105 209 AC / BE	Z = 18/18; 30/10/2007 →	MCK0580	MCK1240
			03C 115 230 C	54 Kettenglieder/Maillons; 30/10/2007 →		
			03C 109 507 AE / J			
			03C 105 209 AM / BE	Z = 18/18	MCK0580	MCK1240
			03C 115 230 C	54 Kettenglieder/Maillons; → 30/10/2007		
			03C 109 507 AE / J			
2008 → 2012			03C 105 209 AC / BE	Z = 18/18; → 21/07/2008	MCK0580	MCK1240
			03C 115 230 C	54 Kettenglieder/Maillons; → 21/07/2008		
			03C 109 507 AE / J			
			03C 105 209 AQ	Z = 18/18; 21/07/2008 →		
			03C 115 225 A	54 Kettenglieder/Maillons; 21/07/2008 →		
			03C 109 507 AD		MCK1210	MCK1240



**MAGNETI
MARELLI**

PARTS & SERVICES

		PARTS	OE			COMPLETE KIT	EASY KIT
AUDI							
A3 Sportback (8PA) 1.4 TFSI (09/07 → 03/13) CAXC; CMSA 92 kW							
2007 → 2008			03C 105 209 AK	Z = 23/18; → 30/10/2007	MCK1200	MCK1240	
			03C 115 225	56 Kettenglieder/Maillons; → 30/10/2007			
			03C 109 507 AF				
			03C 105 209 AC / BE	Z = 18/18; 30/10/2007 →	MCK0580	MCK1240	
			03C 115 230 C	54 Kettenglieder/Maillons; 30/10/2007 →			
			03C 105 209 AM / BE	Z = 18/18	MCK0580	MCK1240	
		03C 115 230 C	54 Kettenglieder/Maillons; → 30/10/2007				
2009 → 2013			03C 105 209 AC / BE	Z = 18/18; → 21/07/2008	MCK0580	MCK1240	
			03C 115 230 C	54 Kettenglieder/Maillons; → 21/07/2008			
			03C 109 507 AE / J				
			03C 105 209 AQ	Z = 18/18; 21/07/2008 →	MCK1210	MCK1240	
			03C 115 225 A	54 Kettenglieder/Maillons; 21/07/2008 →			
			03C 109 507 AD				
A3 Cabriolet (8P7) 1.4 TFSI (02/11 → 05/13) CAXC 92 kW							
			03C 105 209 AQ / AR	Z = 18/18	MCK1210	MCK1240	
			03C 115 225 A	54 Kettenglieder/Maillons			
			03C 109 507 AD				
SEAT							
ALHAMBRA (710, 711) 1.4 TSI (06/10 →) CAVA; CNWB; CTHA 110 kW							
2011 → 2015			03C 105 209 AR	Z = 18/18	MCK1210	MCK1240	
			03C 115 225 A	54 Kettenglieder/Maillons			
			03C 109 507 AD				
ALTEA (5P1) 1.4 TSI (11/07 →) CAXC 92 kW							
2007 → 2010			03C 105 209 AC / BE	Z = 18/18; → 1P-9-023 795	MCK0580	MCK1240	
			03C 115 230 C	54 Kettenglieder/Maillons; → 5P-9-011 823			
			03C 109 507 AE / J				
			03C 105 209 AQ	Z = 18/18; 1P-9-023 795 →	MCK1210	MCK1240	
			03C 115 225 A	54 Kettenglieder/Maillons; 5P-9-011 823 →			
			03C 109 507 AD				
2011 → 2015			03C 105 209 AQ	Z = 18/18	MCK1210	MCK1240	
			03C 115 225 A	54 Kettenglieder/Maillons			
			03C 109 507 AD				
ALTEA XL (5P5, 5P8) 1.4 TSI (11/07 →) CAXC 92 kW							
2007 → 2010			03C 105 209 AC / BE	Z = 18/18; → 1P-9-023 795	MCK0580	MCK1240	
			03C 115 230 C	54 Kettenglieder/Maillons; → 5P-9-011 823			
			03C 109 507 AE / J				
			03C 105 209 AQ	Z = 18/18; 1P-9-023 795 →	MCK1210	MCK1240	
			03C 115 225 A	54 Kettenglieder/Maillons; 5P-9-011 823 →			
			03C 109 507 AD				
2011 → 2015			03C 105 209 AQ	Z = 18/18	MCK1210	MCK1240	
			03C 115 225 A	54 Kettenglieder/Maillons			
			03C 109 507 AD				
CORDOBA (6L2) 1.6 16V (11/06 → 11/09) BTS 77 kW							
			03C 105 209 AC / BE	Z = 18/18	MCK0580	MCK1240	
			03C 115 230 C	54 Kettenglieder/Maillons			
			03C 109 507 AE / J				











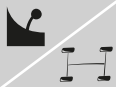









































		PARTS	OE		COMPLETE KIT	EASY KIT
SEAT						
IBIZA III (6L1) 1.6 16V (11/06 → 11/09) BTS 77 kW						
			03C 105 209 AC / BE	Z = 18/18	MCK0580	MCK1240
			03C 115 230 C	54 Kettenglieder/Maillons		
			03C 109 507 AE / J			
IBIZA IV (6J5, 6P1) 1.6 (05/08 → 03/12) BTS 77 kW						
			03C 105 209 AC / BE	Z = 18/18	MCK0580	MCK1240
			03C 115 230 C	54 Kettenglieder/Maillons		
			03C 109 507 AE / J			
IBIZA IV SPORTCOUPE (6J1, 6P5) 1.6 (07/08 → 05/15) BTS 77 kW						
			03C 105 209 AC / BE	Z = 18/18	MCK0580	MCK1240
			03C 115 230 C	54 Kettenglieder/Maillons		
			03C 109 507 AE / J			
IBIZA IV (6J5, 6P1), IBIZA IV SPORTCOUPE (6J1, 6P5) 1.4 TSI (01/09 → 05/15) CAVF; CNUB; CTHF; CTJB 110 kW						
			03C 105 209 AG	Z = 23/18	MCK1200	MCK1240
			03C 115 225	56 Kettenglieder/Maillons		
			03C 109 507 AF			
IBIZA IV SPORTCOUPE (6J1, 6P5) 1.4 TSI Cupra (06/09 → 05/15) CAVE; CTHE; CTJC 132 kW						
			03C 105 209 AG	Z = 23/18	MCK1200	MCK1240
			03C 115 225	56 Kettenglieder/Maillons		
			03C 109 507 AF			
IBIZA IV (6J5, 6P1); IBIZA IV SPORTCOUPE (6J1, 6P5) 1.6 LPG (05/11 → 05/15) CNKA 60 kW						
			03C 105 209 AC / BE	Z = 18/18	MCK0580	MCK1240
			03C 115 230 C	54 Kettenglieder/Maillons		
			03C 109 507 AE / J			
IBIZA IV ST (6J8, 6P8) 1.4 TSI (02/12 → 05/15) CAVF; CNUB; CTHF; CTJB 110 kW						
			03C 105 209 AG	Z = 23/18	MCK1200	MCK1240
			03C 115 225	56 Kettenglieder/Maillons		
			03C 109 507 AF			
LEON (1P1) 1.4 TSI (11/07 → 12/12) CAXC 92 kW						
2007 → 2010			03C 105 209 AC / BE	Z = 18/18; → 1P-9-023 795	MCK0580	MCK1240
			03C 115 230 C	54 Kettenglieder/Maillons; → 1P-9-023 795		
			03C 109 507 AE / J			
			03C 105 209 AQ	Z = 18/18; 1P-9-023 796 →	MCK1210	MCK1240
			03C 115 225 A	54 Kettenglieder/Maillons; 1P-9-023 796 →		
			03C 109 507 AD			
2011 → 2012			03C 105 209 AQ	Z = 18/18	MCK1210	MCK1240
			03C 115 225 A	54 Kettenglieder/Maillons		
			03C 109 507 AD			
TOLEDO IV (KG3) 1.4 TSI (07/12 → 06/15) CAXA 90 kW						
			03C 105 209 AQ	Z = 18/18	MCK1210	MCK1240
			03C 115 225 A	54 Kettenglieder/Maillons		
			03C 109 507 AD			
TOLEDO IV (KG3) 1.6 (07/13 → 06/15) CFNA 77 kW						
			03C 105 209 AC / BE	Z = 18/18	MCK0580	MCK1240
			03C 115 230 C	54 Kettenglieder/Maillons		
			03C 109 507 AE / J			



		PARTS	OE			COMPLETE KIT	EASY KIT
SKODA							
FABIA II (542); FABIA II Combi (545) 1.6 (04/07 → 12/14) BTS; CFNA 77 kW							
			03C 105 209 AC / BE	Z = 18/18			
			03C 115 230 C	54 Kettenglieder/Maillons	MCK0580	MCK1240	
			03C 109 507 AE / J				
FABIA II (542); FABIA II Combi (545) 1.4 TSI RS (05/10 → 12/14) CAVE; CTHE 132 kW							
			03C 105 209 AG	Z = 23/18			
			03C 115 225	56 Kettenglieder/Maillons	MCK1200	MCK1240	
			03C 109 507 AF				
OCTAVIA II (1Z3); OCTAVIA II Combi (1Z5) 1.6 FSI (02/04 → 10/08) BLF 85 kW							
			03C 105 209 AC / BE	Z = 18/18			
			03C 115 230 C	54 Kettenglieder/Maillons	MCK0580	MCK1240	
			03C 109 507 AE / J				
OCTAVIA II (1Z3); OCTAVIA II Combi (1Z5) 1.4 TSI (11/08 → 06/13) CAXA 90 kW							
			03C 105 209 AQ	Z = 18/18; → 11/05/2015			
			03C 115 225 A	54 Kettenglieder/Maillons	MCK1210	MCK1240	
			03C 109 507 AD				
			03C 105 209 BD	Z = 19/18; 11/05/2015 →			
			03C 115 225 A	54 Kettenglieder/Maillons	MCK1220	MCK1250	
			03C 109 507 AD				
RAPID (NH3); RAPID Spaceback (NH1) 1.4 TSI (07/12 → 06/15) CAXA 90 kW							
			03C 105 209 AQ	Z = 18/18; → 11/05/2015			
			03C 115 225 A	54 Kettenglieder/Maillons	MCK1210	MCK1240	
			03C 109 507 AD				
			03C 105 209 BD	Z = 19/18; 11/05/2015 →			
			03C 115 225 A	54 Kettenglieder/Maillons	MCK1220	MCK1250	
			03C 109 507 AD				
RAPID (NH3); RAPID Spaceback (NH1) 1.6 (07/12 → 06/15) CFNA 77 kW							
			03C 105 209 AC / BE	Z = 18/18			
			03C 115 230 C	54 Kettenglieder/Maillons	MCK0580	MCK1240	
			03C 109 507 AE / J				
ROOMSTER (5J7) 1.6 (09/06 → 05/15) BTS; CFNA 77 kW							
			03C 105 209 AC / BE	Z = 18/18			
			03C 115 230 C	54 Kettenglieder/Maillons	MCK0580	MCK1240	
			03C 109 507 AE / J				
ROOMSTER (5J7) 1.6 LPG (06/06 → 07/10) BTS 77 kW							
			03C 105 209 AC / BE	Z = 18/18			
			03C 115 230 C	54 Kettenglieder/Maillons	MCK0580	MCK1240	
			03C 109 507 AE / J				
SUPERB II (3T4); SUPERB II Station wagon (3T5) 1.4 TSI (07/08 → 05/15) CAXC 92 kW							
2008 → 2013			03C 105 209 AQ	Z = 18/18; → 11/05/2015			
			03C 115 225 A	54 Kettenglieder/Maillons; 01/08/2008 →	MCK1210	MCK1240	
			03C 109 507 AD				
			03C 105 209 BD	Z = 19/18; 11/05/2015 →			
			03C 115 225 A	54 Kettenglieder/Maillons	MCK1220	MCK1250	
			03C 109 507 AD				



				PARTS	OE			
							COMPLETE KIT	EASY KIT
SKODA								
YETI (5L) 1.4 TSI (06/10 → 05/15)  CAXA 90 kW								
			03C 105 209 AQ	Z = 18/18; → 11/05/2015				
			03C 115 225 A	54 Kettenglieder/Maillons		MCK1210	MCK1240	
			03C 109 507 AD					
			03C 105 209 BD	Z = 19/18; 11/05/2015 →				
			03C 115 225 A	54 Kettenglieder/Maillons		MCK1220	MCK1250	
			03C 109 507 AD					
VOLKSWAGEN								
BEETLE (5C1, 5C2; BEETLE Cabriolet (5C7, 5C8) 1.4 TSI (10/11 → 07/16)  CAVD; CNWA; CTHD; CTKA 118 kW								
			03C 105 209 AR / AQ	Z = 18/18; → 11/05/2015				
			03C 115 225 A	54 Kettenglieder/Maillons		MCK1210	MCK1240	
			03C 109 507 AD					
			03C 105 209 BD	Z = 19/18; 11/05/2015 →				
			03C 115 225 A	54 Kettenglieder/Maillons		MCK1220	MCK1250	
			03C 109 507 AD					
CC (358) 1.4 TSI (11/11 → 12/16)  CTHD 118 kW								
2012 → 2015								
			03C 105 209 AR / AQ	Z = 18/18; → 24/05/2015				
			03C 115 225 A	54 Kettenglieder/Maillons		MCK1210	MCK1240	
			03C 109 507 AD					
			03C 105 209 BD	Z = 19/18; 25/05/2015 →				
			03C 115 225 A	54 Kettenglieder/Maillons		MCK1220	MCK1250	
			03C 109 507 AD					
CC (358) 1.4 TSI MultiFuel (11/11 → 12/16)  CKMA 118 kW								
2012 → 2015								
			03C 105 209 AR / AQ	Z = 18/18; → 24/05/2015				
			03C 115 225	54 Kettenglieder/Maillons		MCK1210	MCK1240	
			03C 109 507 AD					
			03C 105 209 BD	Z = 19/18; 25/05/2015 →				
			03C 115 225A	54 Kettenglieder/Maillons		MCK1220	MCK1250	
			03C 109 507 AD					
EOS (1F7, 1F8) 1.6 FSI (06/06 → 05/08)  BLF 85 kW								
			03C 105 209 AC / BE	Z = 18/18				
			03C 115 230 C	54 Kettenglieder/Maillons		MCK0580	MCK1240	
			03C 109 507 AE / J					
EOS (1F7, 1F8) 1.4 TSI (11/07 → 08/15)  CAXA 90 kW								
2007 → 2008								
			03C 105 209 AC / BE	Z = 18/18				
			03C 115 230 C	54 Kettenglieder/Maillons		MCK0580	MCK1240	
			03C 109 507 AE / J					
2009 → 2011								
			03C 105 209 AC	Z = 18/18; → 31/07/2008				
			03C 115 230 C	54 Kettenglieder/Maillons; → 31/07/2008		MCK0580	MCK1240	
			03C 109 507 AE / J					
			03C 105 209 AQ	Z = 18/18; 01/08/2008 →				
			03C 115 225 A	54 Kettenglieder/Maillons; 01/08/2008 →		MCK1210	MCK1240	
			03C 109 507 AD					
2012 → 2015								
			03C 105 209 AR / AQ	Z = 18/18; → 24/05/2015				
			03C 115 225 A	54 Kettenglieder/Maillons		MCK1210	MCK1240	
			03C 109 507 AD					
			03C 105 209 BD	Z = 19/18; 25/05/2015 →				
			03C 115 225 A	54 Kettenglieder/Maillons		MCK1220	MCK1250	
			03C 109 507 AD					



				PARTS	OE				COMPLETE KIT	EASY KIT	
VOLKSWAGEN											
EOS (1F7, 1F8) 1.4 TSI → 05/2015 (05/08 → 08/15) CAVD; CTHD 118 kW											
2009 → 2011				03C 105 209 AG	Z = 23/18; → 30/06/2008				MCK1200	MCK1240	
				03C 115 225	56 Kettenglieder/Maillons; → 30/06/2008						
				03C 109 507 AF							
				03C 105 209 AR / AQ	Z = 18/18; 01/07/2008 →						
				03C 115 225 A	54 Kettenglieder/Maillons; 01/07/2008 →						
2011 → 2015				03C 105 209 AR / AQ	Z = 18/18; → 24/05/2015				MCK0580	MCK1240	
				03C 115 225 A	54 Kettenglieder/Maillons						
				03C 109 507 AD							
				03C 105 209 BD	Z = 19/18; 25/05/2015 →						
				03C 115 225 A	54 Kettenglieder/Maillons						
GOLF PLUS (5M1, 521) 1.6 FSI (12/04 → 05/08) BLF 85 kW				03C 105 209 AC / BE	Z = 18/18				MCK0580	MCK1240	
				03C 115 230 C	54 Kettenglieder/Maillons						
				03C 109 507 AE / J							
GOLF PLUS (5M1, 521) 1.4 FSI (07/05 → 11/06) BLN 66 kW				03C 105 209 AC / BE	Z = 18/18				MCK0580	MCK1240	
				03C 115 230 C	54 Kettenglieder/Maillons						
				03C 109 507 AE / J							
GOLF PLUS (5M1, 521) 1.4 TSI (05/06 → 06/08) BMY; BLG 103; 125 kW				03C 105 209 AG	Z = 23/18				MCK1200	MCK1240	
				03C 115 225	56 Kettenglieder/Maillons						
				03C 109 507 AF							
GOLF PLUS (5M1, 521) 1.4 TSI (06/07 → 12/13) CAXA 90 kW	2008 → 2009				03C 105 209 AK / AG	Z = 23/18; → 1K-8-546 000			MCK1200	MCK1240	
					03C 115 225	56 Kettenglieder/Maillons; → 1K-8-546 000					
					03C 109 507 AF						
						03C 105 209 AC / BE	Z = 18/18; 1K-8-546 001 → 1K-9-825 000			MCK0580	MCK1240
						03C 115 230 C	54 Kettenglieder/Maillons; 1K-8-546 001 → 1K-9-825 000				
						03C 109 507 AE / J					
						03C 105 209 AQ	Z = 18/18; 1K-9-825 001 →			MCK1210	MCK1240
						03C 115 225 A	54 Kettenglieder/Maillons; 1K-9-825 001 →				
						03C 109 507 AD					
						03C 105 209 AC / BE	Z = 18/18; → 1K-9-825 000			MCK0580	MCK1240
						03C 115 230 C	→ 1K-9-825 000				
						03C 109 507 AE / J					
					03C 105 209 AQ	Z = 18/18; 1K-9-825 001 →			MCK1210	MCK1240	
					03C 115 225 A	1K-9-825 001 →					
					03C 109 507 AD						
2009 → 2013				03C 105 209 AQ	Z = 18/18				MCK1210	MCK1240	
				03C 115 225 A	54 Kettenglieder/Maillons						
				03C 109 507 AD							



		PARTS		OE				MAGNETI MARELLI PARTS & SERVICES	
								COMPLETE KIT	EASY KIT
VOLKSWAGEN									
GOLF PLUS (5M1, 521) 1.4 TSI (06/08 → 12/13) CAVD; CNWA; CTHD 118 kW									
			03C 105 209 AR / AQ	Z = 18/18	MCK1210	MCK1240			
			03C 115 225 A	54 Kettenglieder/Maillons					
			03C 109 507 AD						
GOLF V (1K1) 1.4 FSI (10/03 → 07/06) BKG; BLN 66 kW									
			03C 105 209 AC / BE	Z = 18/18	MCK0580	MCK1240			
			03C 115 230 C	54 Kettenglieder/Maillons					
			03C 109 507 AE / J						
GOLF V (1K1) 1.6 FSI (10/03 → 07/08) BAG; BLF; BLP 85 kW									
			03C 105 209 AC / BE	Z = 18/18	MCK0580	MCK1240			
			03C 115 230 C	54 Kettenglieder/Maillons					
			03C 109 507 AE / J						
GOLF V (1K1) 1.4 TSI (05/07 → 11/08) CAXA 90 kW									
			03C 105 209 AK / AG	Z = 23/18; → 1K-8P050 000, → 1K-8U010 000, → 1K-8W150 000	MCK1200	MCK1240			
			03C 115 225	56 Kettenglieder/Maillons					
			03C 109 507 AF						
			03C 105 209 AC / BE	Z = 18/18; 1K-8P050 001 →, → 1K-9P025 000, 1K-8U010 001 →, → 1K-9U008 000, 1K-8W150 001 →, → 1K-9W090 000	MCK0580	MCK1240			
			03C 115 230 C	54 Kettenglieder/Maillons					
			03C 109 507 AE / J						
			03C 105 209 AQ	Z = 18/18; 1K-9P025 001 →, 1K-9U008 001 →, 1K-9W090 001 →	MCK1210	MCK1240			
			03C 115 225 A	54 Kettenglieder/Maillons					
			03C 109 507 AD						
			03C 105 209 AC / BE	Z = 18/18; → 1K-9P025 000, → 1K-9U008 000, → 1K-9W090 000	MCK0580	MCK1240			
			03C 115 230 C	54 Kettenglieder/Maillons					
			03C 109 507 AE / J						
			03C 105 209 AQ	Z = 18/18; 1K-9P025 001 →, 1K-9U008 001 →, 1K-9W090 001 →	MCK1210	MCK1240			
			03C 115 225 A	54 Kettenglieder/Maillons					
			03C 109 507 AD						
GOLF V Variant (1K5) 1.4 TSI (06/07 → 07/09) CAXA 90 kW									
			03C 105 209 AK / AG	Z = 23/18; → 31/10/2007	MCK1200	MCK1240			
			03C 115 225	56 Kettenglieder/Maillons					
			03C 109 507 AF						
			03C 105 209 AC / BE	Z = 18/18; 01/11/2007 → 31/07/2008	MCK0580	MCK1240			
			03C 115 230 C	54 Kettenglieder/Maillons					
			03C 109 507 AE / J						
			03C 105 209 AQ	Z = 18/18; 01/08/2008 → 31/06/2009	MCK1210	MCK1240			
			03C 115 225 A	54 Kettenglieder/Maillons					
			03C 109 507 AD						



**MAGNETI
MARELLI**

PARTS & SERVICES

		PARTS	OE			COMPLETE KIT	EASY KIT
VOLKSWAGEN							
GOLF VI (5K1) 1.4 TSI (10/08 → 11/12) CAXA 90 kW							
2008 → 2009			03C 105 209 AK / AG	Z = 23/18; → 1K-8P050 000, → 1K-8U010 000, → 1K-8W150 000	MCK1200	MCK1240	
			03C 115 225	56 Kettenglieder/Maillons			
			03C 109 507 AF				
			03C 105 209 AC / BE	Z = 18/18; 1K-8P050 001 →, → 1K-9P025 000, 1K-8U010 001 →, → 1K-9U008 000, 1K-8W150 001 →, → 1K-9W090 000	MCK0580	MCK1240	
			03C 115 230 C	54 Kettenglieder/Maillons			
			03C 109 507 AE / J				
			03C 105 209 AQ	Z = 18/18; 1K-9P025 001 →, 1K-9U008 001 →, 1K-9W090 001 →	MCK1210	MCK1240	
			03C 115 225 A	54 Kettenglieder/Maillons			
			03C 109 507 AD				
			03C 105 209 AC / BE	Z = 18/18; → 1K-9P025 000, → 1K-9U008 000, → 1K-9W090 000	MCK0580	MCK1240	
			03C 115 230 C	54 Kettenglieder/Maillons			
			03C 109 507 AE / J				
			03C 105 209 AQ	Z = 18/18; 1K-9P025 001 →, 1K-9U008 001 →, 1K-9W090 001 →	MCK1210	MCK1240	
			03C 115 225 A	54 Kettenglieder/Maillons			
			03C 109 507 AD				
2009 → 2012		03C 105 209 AQ	Z = 18/18	MCK1210	MCK1240		
		03C 115 225 A	54 Kettenglieder/Maillons				
		03C 109 507 AD					
GOLF VI (5K1) 1.4 TSI (10/08 → 11/12) CAVD; CNWA; CTHD 118 kW							
		03C 105 209 AQ / AR	Z = 18/18	MCK1210	MCK1240		
		03C 115 225 A	54 Kettenglieder/Maillons				
		03C 109 507 AD					
GOLF VI Cabriolet (517) 1.4 TSI (03/11 → 05/16) CAVD; CNWA; CTHD; CTKA 118 kW							
		03C 105 209 AR / AQ	Z = 18/18; → 24/05/2015	MCK1210	MCK1240		
		03C 115 225 A	54 Kettenglieder/Maillons				
		03C 109 507 AD					
		03C 105 209 BD	Z = 19/18; 25/05/2015 →	MCK1220	MCK1250		
		03C 115 225 A	54 Kettenglieder/Maillons				
	03C 109 507 AD						
GOLF VI Cabriolet (517) 1.4 TSI (11/11 → 05/16) CAXA 90 kW							
		03C 105 209 AR / AQ	Z = 18/18; → 24/05/2015	MCK1210	MCK1240		
		03C 115 225 A	54 Kettenglieder/Maillons				
		03C 109 507 AD					
		03C 105 209 BD	Z = 19/18; 25/05/2015 →	MCK1220	MCK1250		
		03C 115 225 A	54 Kettenglieder/Maillons				
	03C 109 507 AD						
JETTA III (1K2) 1.6 FSI (09/05 → 10/10) BLF 85 kW							
		03C 105 209 AC / BE	Z = 18/18	MCK0580	MCK1240		
		03C 115 230 C	54 Kettenglieder/Maillons				
		03C 109 507 AE / J					
JETTA III (1K2) 1.4 TSI (07/06 → 10/10) BMY; BLG 103; 125 kW							
		03C 105 209 AG	Z = 23/18	MCK1200	MCK1240		
		03C 115 225	56 Kettenglieder/Maillons				
		03C 109 507 AF					



		PARTS	OE		MAGNETI MARELLI PARTS & SERVICES	
					COMPLETE KIT	EASY KIT
VOLKSWAGEN						
JETTA III (1K2) 1.4 TSI (05/07 → 10/10) CAXA 90 kW						
2007 → 2008			03C 105 209 AK / AG	Z = 23/18	MCK1200	MCK1240
			03C 115 225	56 Kettenglieder/Maillons		
			03C 109 507 AF			
			03C 105 209 AC / BE	Z = 18/18	MCK0580	MCK1240
			03C 115 230 C	54 Kettenglieder/Maillons		
			03C 109 507 AE / J			
2009 → 2010			03C 105 209 AC	Z = 18/18; → 31/07/2008	MCK0580	MCK1240
			03C 115 230 C	54 Kettenglieder/Maillons		
			03C 109 507 AE / J			
			03C 105 209 AQ	Z = 18/18; 01/08/2008 →		
			03C 115 225 A	54 Kettenglieder/Maillons		
			03C 109 507 AD		MCK1210	MCK1240
JETTA IV (162, 163, AV3, AV2) 1.4 TSI (05/11 →) CAXA; CMSB; CAVA; CTHA; CAVD; CTHD 90; 110; 118 kW						
2011 → 2014			03C 105 209 AQ / AR	Z = 18/18	MCK1210	MCK1240
			03C 115 225 A	54 Kettenglieder/Maillons		
			03C 109 507 AD			
2015 → 2018			03C 105 209 AR / AQ	Z = 18/18; → 11/05/2015	MCK1210	MCK1240
			03C 115 225 A	54 Kettenglieder/Maillons		
			03C 109 507 AD			
			03C 105 209 BD	Z = 19/18; 12/05/2015 →		
			03C 115 225 A	54 Kettenglieder/Maillons		
			03C 109 507 AD		MCK1220	MCK1250
JETTA IV (162, 163, AV3, AV2) 1.6 (12/11 →) CFNA; CLRA 77 kW						
			03C 105 209 AC / BE	Z = 18/18	MCK0580	MCK1240
			03C 115 230 C	54 Kettenglieder/Maillons		
			03C 109 507 AE / J			
PASSAT (3C2) 1.6 FSI (03/05 → 06/08) BLF 85 kW						
			03C 105 209 AC / BE	Z 18/18	MCK0580	MCK1240
			03C 115 230 C	54 Kettenglieder/Maillons		
			03C 109 507 J / AE			
PASSAT (3C2) 1.4 TSI (05/07 → 07/10) CAXA 90 kW						
2007 → 2008			03C 105 209 AK	Z = 23/18; → 3C-8E110 000, → 3C-8P060 000	MCK1200	MCK1240
			03C 115 225	56 Kettenglieder/Maillons		
			03C 109 507 AB/ AF			
			03C 105 209 AC / BE	Z = 18/18; 3C-8E110 001 →, 3C-8P060 001 →		
			03C 115 230 C	54 Kettenglieder/Maillons		
			03C 109 507 AE		MCK0580	MCK1240
2009 → 2010			03C 105 209 AC / BE	Z = 18/18; → 31/07/2008	MCK0580	MCK1240
			03C 115 230 C	54 Kettenglieder/Maillons		
			03C 109 507 AE			
			03C 105 209 AQ	Z = 18/18; 01/08/2008 →		
			03C 115 225 A	54 Kettenglieder/Maillons		
			03C 109 507 AD		MCK1210	MCK1240
PASSAT (3C2) 1.4 TSI EcoFuel (01/09 → 07/10) CDGA 110 kW						
			03C 105 209 AG	Z = 23/18	MCK1200	MCK1240
			03C 115 225	56 Kettenglieder/Maillons		
			03C 109 507 AF			



				PARTS	OE			
							COMPLETE KIT	EASY KIT
VOLKSWAGEN								
*	PASSAT (362) 1.4 TSI	(08/10 → 12/14)		CAXA	90 kW			
	2010 → 2011			03C 105 209 AC / BE	Z = 18/18; → 31/07/2008		MCK0580	MCK1240
				03C 115 230 C	54 Kettenglieder/Maillons			
				03C 109 507 AE / J				
				03C 105 209 AQ	Z = 18/18; 01/08/2008 →		MCK1210	MCK1240
				03C 115 225 A	54 Kettenglieder/Maillons			
				03C 109 507 AD				
	2012 → 2014			03C 105 209 AQ	Z = 18/18		MCK1210	MCK1240
				03C 115 225 A	54 Kettenglieder/Maillons			
				03C 109 507 AD				
*	PASSAT (362) 1.4 TSI EcoFuel	(08/10 → 12/14)		CDGA	110 kW			
				03C 105 209 AG	Z = 23/18		MCK1200	MCK1240
				03C 115 225	56 Kettenglieder/Maillons			
				03C 109 507 AF				
*	PASSAT (362) 1.4 TSI MultiFuel	(11/10 → 12/14)		CKMA	118 kW			
				03C 105 209 AG	Z = 23/18		MCK1200	MCK1240
				03C 115 225	56 Kettenglieder/Maillons			
				03C 109 507 AF				
*	PASSAT (362) 1.4 TSI	(11/12 → 12/14)		CTHD	118 kW			
				03C 105 209 AG	Z = 23/18		MCK1200	MCK1240
				03C 115 225	56 Kettenglieder/Maillons			
				03C 109 507 AF				
	PASSAT CC (357) 1.4 TSI MultiFuel	(01/11 → 01/12)		CKMA	118 kW			
				03C 105 209 AG	Z = 23/18		MCK1200	MCK1240
				03C 115 225	56 Kettenglieder/Maillons			
				03C 109 507 AF				
	PASSAT Variant (3C5) 1.6 FSI	(08/05 → 06/08)		BLF	85 kW			
				03C 105 209 AC / BE	Z = 18/18		MCK0580	MCK1240
				03C 115 230 C	54 Kettenglieder/Maillons			
				03C 109 507 J / AE				
	PASSAT Variant (3C5) 1.4 TSI	(05/07 → 11/10)		CAXA	90 kW			
	2007 → 2008			03C 105 209 AK	Z = 23/18; → 3C-8E110 000, → 3C-8P060 000		MCK1200	MCK1240
				03C 115 225	56 Kettenglieder/Maillons			
				03C 109 507 AB/ AF				
				03C 105 209 AC / BE	Z = 18/18; 3C-8E110 001 →, 3C-8P060 001 →		MCK0580	MCK1240
				03C 115 230 C	54 Kettenglieder/Maillons			
				03C 109 507 AE				
	2009 → 2010			03C 105 209 AC / BE	Z = 18/18; → 31/07/2008		MCK0580	MCK1240
				03C 115 230 C	54 Kettenglieder/Maillons			
				03C 109 507 AE				
				03C 105 209 AQ	Z = 18/18; 01/08/2008 →		MCK1210	MCK1240
				03C 115 225 A	54 Kettenglieder/Maillons			
				03C 109 507 AD				
	PASSAT Variant (3C5) 1.4 TSI EcoFuel	(01/09 → 11/10)		CDGA	110 kW			
				03C 105 209 AG	Z = 23/18		MCK1200	MCK1240
				03C 115 225	56 Kettenglieder/Maillons			
				03C 109 507 AF				



		PARTS	OE			COMPLETE KIT	EASY KIT
VOLKSWAGEN							
* PASSAT Variant (365) 1.4 TSI (08/10 → 12/14) CAXA 90 kW							
2010 → 2011			03C 105 209 AC / BE	Z 18/18; → 31/07/2008	MCK0580	MCK1240	
			03C 115 230 C	54 Kettenglieder/Maillons			
			03C 109 507 AE				
			03C 105 209 AQ	Z = 18/18; 01/08/2008 →	MCK120	MCK1240	
			03C 115 225 A	54 Kettenglieder/Maillons			
		03C 109 507 AD					
2011 → 2014			03C 105 209 AQ	Z = 18/18; 01/08/2008 →	MCK1210	MCK1240	
			03C 115 225 A	54 Kettenglieder/Maillons			
			03C 109 507 AD				
* PASSAT Variant (365) 1.4 TSI EcoFuel (08/10 → 12/14) CDGA 110 kW							
			03C 105 209 AG	Z = 23/18	MCK1200	MCK1240	
			03C 115 225	56 Kettenglieder/Maillons			
			03C 109 507 AF				
* PASSAT Variant (365) 1.4 TSI MultiFuel (11/10 → 12/14) CKMA 118 kW							
			03C 105 209 AG	Z = 23/18	MCK1200	MCK1240	
			03C 115 225	56 Kettenglieder/Maillons			
			03C 109 507 AF				
* PASSAT Variant (365) 1.4 TSI (11/12 → 12/14) CTHD 118 kW							
			03C 105 209 AG	Z = 23/18	MCK1200	MCK1240	
			03C 115 225	56 Kettenglieder/Maillons			
			03C 109 507 AF				
POLO (9N_) 1.4 FSI (02/02 → 07/06) AXU 63 kW							
			03C 105 209 AC / BE	Z = 18/18	MCK0580	MCK1240	
			03C 115 230 C	54 Kettenglieder/Maillons			
			03C 109 507 AE				
POLO (9N_) 1.6 16V (05/06 → 11/09) BTS 77 kW							
			03C 105 209 AC / BE	Z = 18/18	MCK0580	MCK1240	
			03C 115 230 C	54 Kettenglieder/Maillons			
			03C 109 507 AE				
POLO (6R1, 6C1) 1.4 (6R1) (03/09 → 05/14) ; CLPA 63 kW							
			03C 105 209 AC / BE	Z = 18/18	MCK0580	MCK1240	
			03C 115 230 C	54 Kettenglieder/Maillons			
			03C 109 507 AE				
POLO (6R1, 6C1) 1.4 GTI (05/10 →) CAVE; CTHE 132 kW							
			03C 105 209 AG	Z = 23/18	MCK1200	MCK1240	
			03C 115 225	56 Kettenglieder/Maillons			
			03C 109 507 AF				
POLO (6R1, 6C1) 1.6 BiFuel (01/11 →) CNKA 60 kW							
			03C 105 209 AC / BE	Z = 18/18	MCK0580	MCK1240	
			03C 115 230 C	54 Kettenglieder/Maillons			
			03C 109 507 AE				



				PARTS	OE			
							COMPLETE KIT	EASY KIT
VOLKSWAGEN								
SCIROCCO (137, 138) 1.4 TSI (08/08 → 11/17) CAXA; CMSB 90 kW								
2008 → 2015		03C 105 209 AQ	Z = 18/18					
		03C 115 225 A	54 Kettenglieder/Maillons		MCK1210		MCK1240	
		03C 109 507 AD						
2015 → 2018		03C 105 209 AQ	Z = 18/18; → 24/05/2015					
		03C 115 225 A	54 Kettenglieder/Maillons		MCK1210		MCK1240	
		03C 109 507 AD						
		03C 105 209 BD	Z = 19/18; 25/05/2015 →					
		03C 115 225 A	54 Kettenglieder/Maillons		MCK1220		MCK1250	
		03C 109 507 AD						
SCIROCCO (137, 138) 1.4 TSI (05/08 → 11/17) CAVD; CNWA; CTHD; CTKA 118 kW								
2008 → 2014		03C 105 209 AG	Z = 23/18; → 30/06/2008					
		03C 115 225	56 Kettenglieder/Maillons		MCK1200		MCK1240	
		03C 109 507 AF						
		03C 105 209 AR / AQ	Z = 18/18; 01/07/2008 →					
		03C 115 225 A	54 Kettenglieder/Maillons		MCK1210		MCK1240	
2015 → 2018		03C 105 209 AQ	Z = 18/18; → 24/05/2015					
		03C 115 225 A	54 Kettenglieder/Maillons		MCK1210		MCK1240	
		03C 109 507 AD						
		03C 105 209 BD	Z = 19/18; 25/05/2015 →					
		03C 115 225 A	54 Kettenglieder/Maillons		MCK1220		MCK1250	
		03C 109 507 AD						
SHARAN (7N1, 7N2) 1.4 TSI (05/10 →) CAVA; CNWB; CTHA 110 kW								
2010 → 2016		03C 105 209 AR	Z = 18/18; → 24/05/2015					
		03C 115 225 A	54 Kettenglieder/Maillons		MCK1210		MCK1240	
		03C 109 507 AD						
		03C 105 209 BD	Z = 19/18; 25/05/2015 →					
		03C 115 225 A	54 Kettenglieder/Maillons		MCK1220		MCK1250	
		03C 109 507 AD						
TIGUAN (5N_) 1.4 TSI (08/10 → 07/18) CAXA 90 kW								
2010 → 2011		03C 105 209 AQ	Z = 18/18					
		03C 115 225 A	54 Kettenglieder/Maillons		MCK1210		MCK1240	
		03C 109 507 AD						
2010 → 2011		03C 105 209 AR / AQ	Z = 18/18; → 24/05/2015					
		03C 115 225 A	54 Kettenglieder/Maillons		MCK1210		MCK1240	
		03C 109 507 AD						
		03C 105 209 BD	Z = 19/18; 25/05/2015 →					
		03C 115 225 A	54 Kettenglieder/Maillons		MCK1220		MCK1250	
		03C 109 507 AD						



				PARTS	OE			
							COMPLETE KIT	EASY KIT
VOLKSWAGEN								
TIGUAN (5N_) 1.4 TSI 4motion (09/07 → 07/18) BWK; CAVA; CTHA 110 kW								
2008 → 2011	AWD/4WD		03C 105 209 AG	Z = 23/18; → 02/11/2008				
			03C 115 225	56 Kettenglieder/Maillons	MCK1200	MCK1240		
			03C 109 507 AF					
			03C 105 209 AR	Z = 18/18; 03/11/2008 →				
			03C 115 225 A	54 Kettenglieder/Maillons	MCK1210	MCK1240		
			03C 109 507 AD					
2012 → 2018			03C 105 209 AR / AQ	Z = 18/18; → 24/05/2015				
			03C 115 225 A	54 Kettenglieder/Maillons	MCK1210	MCK1240		
			03C 109 507 AD					
			03C 105 209 BD	Z = 19/18; 25/05/2015 →				
			03C 115 225 A	54 Kettenglieder/Maillons	MCK1220	MCK1250		
			03C 109 507 AD					
TIGUAN (5N_) 1.4 TSI (05/08 → 07/18) CAVA, CTHA 110 kW								
2008 → 2011	AWD/4WD		03C 105 209 AG	Z = 23/18; → 02/11/2008 (4 motion)				
			03C 115 225	56 Kettenglieder/Maillons	MCK1200	MCK1240		
			03C 109 507 AF					
	FWD		03C 105 209 AR	Z = 18/18; → 02/11/2008 (FWD)				
			03C 115 225 A	54 Kettenglieder/Maillons	MCK1210	MCK1240		
			03C 109 507 AD					
2012 → 2018			03C 105 209 AR / AQ	Z = 18/18; → 24/05/2015				
			03C 115 225 A	54 Kettenglieder/Maillons	MCK1210	MCK1240		
			03C 109 507 AD					
			03C 105 209 BD	Z = 19/18; 25/05/2015 →				
			03C 115 225 A	54 Kettenglieder/Maillons	MCK1220	MCK1250		
			03C 109 507 AD					
TIGUAN (5N_) 1.4 TSI; 1.4 TSI 4motion (05/11 → 07/18) CAVD; CTHD 118 kW								
			03C 105 209 AR / AQ	Z = 18/18; → 24/05/2015				
			03C 115 225 A	54 Kettenglieder/Maillons	MCK1210	MCK1240		
			03C 109 507 AD					
			03C 105 209 BD	Z = 19/18; 25/05/2015 →				
			03C 115 225 A	54 Kettenglieder/Maillons	MCK1220	MCK1250		
			03C 109 507 AD					
TOURAN (1T1, 1T2) 1.6 FSI (02/03 → 01/07) BAG; BLF; BLP 85 kW								
			03C 105 209 AC / BE	Z = 18/18				
			03C 115 230 C	56 Kettenglieder/Maillons	MCK0580	MCK1240		
			03C 109 507 J / AE					
TOURAN (1T1, 1T2) 1.4 TSI (02/06 → 05/10) BMY; CAVC 103 kW								
2006 → 2008			03C 105 209 AF / AG	Z = 23/18				
			03C 115 225	56 Kettenglieder/Maillons	MCK1200	MCK1240		
			03C 109 507 AF					
2009 → 2010			03C 105 209 AF / AG	Z = 23/18; → 1T-9-150 000				
			03C 115 225	56 Kettenglieder/Maillons	MCK1200	MCK1240		
			03C 109 507 AF					
			03C 105 209 AR	Z = 18/18; 1T-9-150 001 →				
			03C 115 225 A	54 Kettenglieder/Maillons	MCK1210	MCK1240		
			03C 109 507 AD					



		PARTS	OE			COMPLETE KIT	EASY KIT
VOLKSWAGEN							
TOURAN (1T1, 1T2) 1.4 FSI (11/06 → 05/10) BLG; CAVB 125 kW							
2006 → 2008			03C 105 209 AF / AG	Z = 23/18			
			03C 115 225	56 Kettenglieder/Maillons	MCK1200	MCK1240	
			03C 109 507 AF				
2009 → 2010			03C 105 209 AF / AG	Z = 23/18; → 1T-9-150 000			
			03C 115 225	56 Kettenglieder/Maillons	MCK1200	MCK1240	
			03C 109 507 AF				
			03C 105 209 AR	Z = 18/18; 1T-9-150 001 →			
			03C 115 225 A	54 Kettenglieder/Maillons	MCK1210	MCK1240	
			03C 109 507 AD				
TOURAN (1T1, 1T2) 1.4 TSI EcoFuel (05/09 → 05/10) CDGA 110 kW							
			03C 105 209 AG	Z = 23/18			
			03C 115 225	56 Kettenglieder/Maillons	MCK1200	MCK1240	
			03C 109 507 AF				
TOURAN (1T3) 1.4 TSI (05/10 → 05/15) CAVC; CTHC 103 kW							
2010			03C 105 209 AF / AG	Z = 23/18; → 1T-9-150 000			
			03C 115 225	56 Kettenglieder/Maillons	MCK1200	MCK1240	
			03C 109 507 AF				
			03C 105 209 AR	Z = 18/18; 1T-9-150 001 →			
			03C 115 225 A	54 Kettenglieder/Maillons	MCK1210	MCK1240	
			03C 109 507 AD				
2011 → 2015			03C 105 209 AR	Z = 18/18			
			03C 115 225 A	54 Kettenglieder/Maillons	MCK1210	MCK1240	
			3C 109 507 AD				
TOURAN (1T3) 1.4 TSI (05/10 → 05/15) CAVB; CTHB 125 kW							
2010			03C 105 209 AF / AG	Z = 23/18; → 1T-9-150 000			
			03C 115 225	56 Kettenglieder/Maillons	MCK1200	MCK1240	
			03C 109 507 AF				
			03C 105 209 AR	Z = 18/18; 1T-9-150 001 →			
			03C 115 225 A	54 Kettenglieder/Maillons	MCK1210	MCK1240	
			03C 109 507 AD				
2011 → 2015			03C 105 209 AR	Z = 18/18			
			03C 115 225 A	54 Kettenglieder/Maillons	MCK1210	MCK1240	
			3C 109 507 AD				
TOURAN (1T3) 1.4 TSI EcoFuel (05/10 → 05/15) CDGA 110 kW							
			03C 105 209 AG	Z = 23/18			
			03C 115 225	56 Kettenglieder/Maillons	MCK1200	MCK1240	
			03C 109 507 AF				



* Die Fahrzeuge **VOLKSWAGEN PASSAT (362) 1.4 TSI**, produziert von 08/2010 bis 12/2014 und **VOLKSWAGEN PASSAT Variant (365) 1.4 TSI**, produziert von 08/2010 bis 12/2014, die im Zweijahreszeitraum 2010-2011 gebaut wurden, liegen in dem Generationswechsel von der sechsten (B6) zur siebten (B7) Generation.

Laut dem OE-Programm, könnte eine Ritzel - Kurbelwellen Konfiguration der vorherigen Generation installiert sein.

Bei diesen Fahrzeugen ist die Wahl des richtigen Steuerkettensatzes abhängig von dem Baujahr und Monat der Produktion, was keine einfache Aufgabe ist, da es möglich ist, dass sich dies vom Zulassungsjahr im Fahrzeugschein unterscheiden kann.







Nachfolgend finden Sie eine zusätzliche Einschränkungstabelle die zu berücksichtigen ist:

*Les véhicules **VOLKSWAGEN PASSAT (362) 1.4 TSI**, fabriqués à partir de 08/2010 à 12/2014 et **VOLKSWAGEN PASSAT Variant (365) 1.4 TSI**, fabriqués à partir de 08/2010 à 12/2014, assemblés au cours de la période 2010-2011, sont au cœur du changement de génération, qui passe de la sixième (B6) à la septième (B7).*

Pour cette raison, selon les références OE, la configuration pignon-vilebrequin installée pourrait être celle de la génération précédente.

Sur ces véhicules, le choix du bon kit de chaîne de distribution est lié à l'identification du mois et de l'année de production, ce qui n'est pas évident (elle peut être différente de la date de mise en circulation inscrite sur la carte grise du véhicule).

Voici ci-dessous un tableau des informations supplémentaires à prendre en compte :

		KOMPONENTEN COMPOSANTS	OE		MAGNETI MARELLI PARTS & SERVICES	
					COMPLETE KIT	EASY KIT
→ 2009 (D>>-MJ 2009)		Ritzel Pignon	03C 105 209 AC / BE	Z =18/18; → 31/07/2008	MCK0580	MCK1240
		Kurbelwelle Vilebrequin	03C 105 101 BF/BM			
		Axial Lager Palier de butée	06B 105 313 D			
		Ritzel Pignon	03C 105 209 AQ	Z =18/18; 01/08/2008 →	MCK1210	MCK1240
		Kurbelwelle Vilebrequin	03C 105 101 BF/BM			
		Axial Lager Palier de butée	06B 105 313 D			
2010 (D-MJ 2010>>>) → 2012		Ritzel Pignon	03C 105 209 AQ	Z = 18/18	MCK1210	MCK1240
		Kurbelwelle Vilebrequin	03C 105 101 BF/BM			
		Axial Lager Palier de butée	06B 105 313 D			
2012 →		Ritzel Pignon	03C 105 209 AQ	Z = 18/18	MCK1210	MCK1240
		Kurbelwelle Vilebrequin	03C 105 101 BM			
		Axial Lager Palier de butée	06B 105 313 D			

In Anbetracht all dieser verschiedenen Variablen empfehlen wir dringend anhand der OE-Referenzen die am Fahrzeug verbauten Komponenten zu überprüfen, um den richtigen Steuerketten Ersatz zu identifizieren.

Compte tenu de toutes ces différentes variables, nous vous recommandons fortement de vérifier, grâce aux références OE, les composants installés sur le véhicule, afin d'identifier le bon kit de remplacement de chaîne de distribution.



Fahrzeugproduktionsjahre | Années de production du véhicule

**MAGNETI
MARELLI**

PARTS & SERVICES

FPM- und PTFE-Öldichtungen

ANWEISUNGEN UND VORSICHTSMASSNAHMEN FÜR DIE ORDNUNGSGEMÄSSE INSTALLATION

Die Kettensätze von Magneti Marelli Parts & Services enthalten zwei Arten von Öldichtungen, zum einen **FPM** (Fluorkautschuk) und zum anderen **PTFE** (Polytetrafluorethylen).

Die beiden Öldichtungen unterscheiden sich nicht nur in Bezug auf das Material, aus dem sie hergestellt sind, sondern auch im Bezug auf die Methode der korrekten Installation und der entsprechenden Vorsichtsmaßnahmen.

FPM (Fluorkautschuk) Öldichtungen

Eigenschaften

- Diese Wellendichtringe gelten als der „traditionellen“ Typ.
- Sie bilden eine physikalische Barriere zwischen der inneren Komponenten, die in Kontakt mit der Flüssigkeit stehen und der äußeren Komponenten.
- Im Inneren befindet sich eine Metallfeder, die Druck auf den gesamten Umfang der inneren Öldichtlippe ausübt und so die Dichtigkeit verbessert.

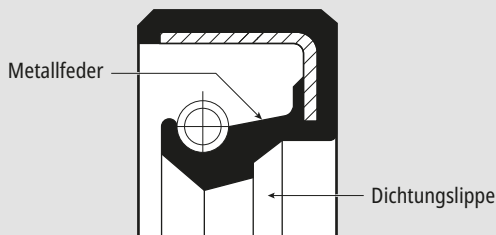

Einbauhinweise

- Prüfen Sie die Dichtungsdaten (Größe und Drehrichtung) und den Typ des Öl Dichtungsmaterials, das ersetzt werden soll.
- Entfernen Sie Schmutz und Ablagerungen von allen Metallflächen, die mit dem Wellendichtring in Berührung kommen.
- **Tragen Sie keine Fette oder Schmiermittel auf die Außenfläche der Öldichtung oder des Dichtungsgehäuses.** Wenn diese Oberflächen verunreinigt sind, wird die äußere Abdichtung beeinträchtigt, sobald die Dichtung montiert ist.
- **Tragen Sie Fett nur auf die innere Dichtlippe des Wellendichtrings und die Gleitfläche der Welle.**
- Montieren Sie den Dichtring mit den entsprechenden Werkzeugen. Die Seite mit den Dichtungsdaten muss nach außen zeigen.



Der Wellendichtring ist nach Installation schnell einsatzbereit und somit kann der Motor nach Zehn Minuten gestartet werden.

PTFE (Polytetrafluorethylen) Wellendichtring

Merkmale

Trotz des Fehlens einer inneren Metallfeder haben diese Wellendichtringe folgende Eigenschaften:

- Größere Dichtfläche in Kontakt mit dem Metall, dadurch erhöhte Dichtigkeit.
- Verbesserte mechanische Belastbarkeit auch bei hohen Drehzahlen.
- Verbesserte chemische Beständigkeit gegen Schmierstoffe mit Additiven.
- Verbesserte Beständigkeit gegen hohe Temperaturen.
- Deutliche Reduzierung von Undichtigkeiten aufgrund von Reibung.

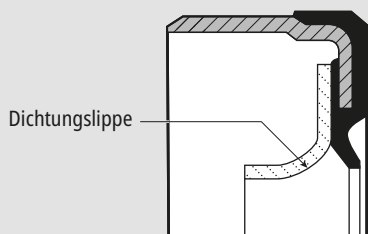

Einbauhinweise



Diese Wellendichtringe werden anders eingebaut als „herkömmliche“ Wellendichtringe aus FPM; die innere Lippe ist durch eine Kunststoffhülse geschützt, die die Form des Dichtrings beibehält und eine perfekte Haftung auf der Welle gewährleistet. **Die Hülse darf erst bei der Montage des Wellendichtrings entfernt werden.**

- Für die Montage des Wellendichtrings sind spezielle Werkzeuge erforderlich. **Beschädigen Sie nicht die Innenlippe des Dichtrings.**
- Der PTFE-Öldichtring ist trocken zu installieren, ohne Verwendung von Fett und/oder Schmiermitteln. **Dieser Wellendichtring darf niemals geschmiert werden.**
- Überprüfen Sie die Dichtungsdaten (Größe und Drehrichtung) und den Typ des zu ersetzenden Dichtungsmaterials.
- Entfernen Sie Schmutz und Ablagerungen von allen Metallflächen, die mit dem Wellendichtring in Kontakt kommen.
- Prüfen Sie die Oberfläche der Welle und stellen Sie sicher, dass sie frei von Rillen oder andere Beschädigungen sind. Alle Unebenheiten müssen beseitigt werden.
- Setzen Sie das gerillte Ende der Hülse auf die Welle. Setzen Sie den Wellendichtring in das Gehäuse ein, indem Sie ihn entlang der Hülse schieben. Sobald der Wellendichtring in seinem Gehäuse sitzt, entfernen Sie die Hülse.



Der PTFE-Öldichtring ist nicht sofort einsatzbereit. Warten Sie bis zu vier Stunden nach dem Einbau, bevor Sie den Motor starten, damit sich die neue Dichtung an die Komponenten anpassen kann, um eine vollständige Dichtigkeit zu gewährleisten.

Die in dieser Publikation enthaltenen Anweisungen, Empfehlungen und Informationen wurden mit größter Sorgfalt erstellt. Marelli Aftermarket Italy S.p.A. übernimmt im Namen und im Auftrag ihrer Tochtergesellschaften keine Verantwortung für Schäden jeglicher Art, die sich auch aus einer falschen Auslegung der darin enthaltenen Informationen ergeben.

**MAGNETI
MARELLI**

PARTS & SERVICES

MCK0580

PROCÉDURE DE CALAGE DE LA CHAÎNE DE DISTRIBUTION

Constructeurs : **Audi, Volkswagen**Modèles : **Audi A3, Volkswagen EOS, Golf V, Golf Plus, Jetta III, Passat VI, Touran**Code moteur : **BAG, BLF, BLG, BLP, BMY**Puissance : **1.4 FSI, 1.4 TSI, 1.6 FSI (115, 140, 170 CV)**Année de production : **02/2003 →**

Précautions générales

- Toujours débrancher le câble de masse de la batterie.
- Retirez les bougies d'allumage pour permettre au moteur de tourner plus librement.
- Toujours faire tourner le moteur dans le sens normal de rotation (sauf indication contraire).
- Respectez les couples de serrage.
- Le cas échéant : notez la position du capteur de position de l'arbre moteur avant le démontage.
- **NE PAS TOURNER** l'arbre moteur en tournant l'arbre à cames ou autres pignons.
- **NE PAS TOURNER** l'arbre moteur ou l'arbre à cames lorsque la chaîne de distribution est retirée.

Outillage spécifique

- Horloge de mesure - n. VAS 6970.
- Support d'horloge de mesure - n. T10170.
- Outil d'alignement d'arbre à cames - n. T10171.
- Outil de blocage de pignon d'arbre à cames - pompe à huile - n. T10172.
- Outil de blocage d'arbre moteur - n. T10340.
- Outil de blocage de poulie d'arbre moteur - n. 3415.
- Goupille de blocage du tendeur de chaîne - n. T40011.

Procédure de calage de la chaîne distribution

- Pour démonter/monter la chaîne de distribution, il est nécessaire de :
 - Retirer le couvercle de la distribution du moteur
 - Retirer la coupelle

! Marquez le sens de rotation sur les chaînes.

- Insérez l'horloge de mesure et son support dans le trou de la bougie d'allumage pour le cylindre n. 1. Assurez-vous que le moteur est au PMH du cylindre n. 1 **1**.
- Assurez-vous que les repères de calage sur l'arbre à cames sont alignés comme illustré **2**.

Sinon, tournez l'arbre moteur de 360°.

- Insérez l'outil d'alignement d'arbre à cames **3**.

! Si l'outil d'alignement d'arbre à cames ne peut pas être inséré, le calage de la chaîne de distribution n'est pas correct.

- Appuyez sur le tendeur de chaîne et bloquez-le avec la goupille de blocage **4**.

- Démontez le pignon d'arbre à cames et la chaîne.
- Alignez les arbres à cames. Utilisez l'outil adapté **3**.

- Montez le pignon d'arbre à cames et la chaîne de distribution.
 - **Moteurs avec système de distribution à calage variable :** Mettez une nouvelle vis. Serrez la vis du dispositif de réglage de l'arbre à cames d'admission **5**. Couple de serrage : 40 Nm + 90°.

! La vis du pignon d'arbre à cames d'admission est fileté en sens inverse.

- **Moteurs sans système de distribution à calage variable :** Serrez la vis du pignon d'arbre à cames d'admission **6**. Couple de serrage : 50 Nm + 90°.
- Serrez la vis du pignon d'arbre à cames d'échappement. Couple de serrage : 50 Nm + 90°.
- Serrez la vis de poulie d'arbre moteur. Couple de serrage **7** :

- A = 150 Nm + 180°
- B = 90 Nm + 90°

! La vis de poulie d'arbre moteur et toutes les vis de pignon d'arbre à cames **DOIVENT** être utilisés une seule fois.

- Démontez l'outil d'alignement d'arbre à cames. Tournez l'arbre moteur dans le sens des aiguilles d'une montre pendant deux tours.
- Vérifiez le calage de la chaîne de distribution **3**.

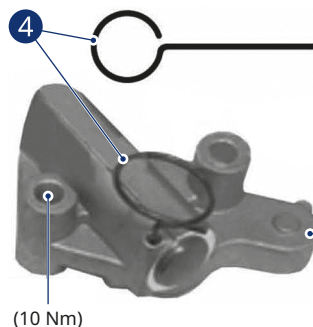
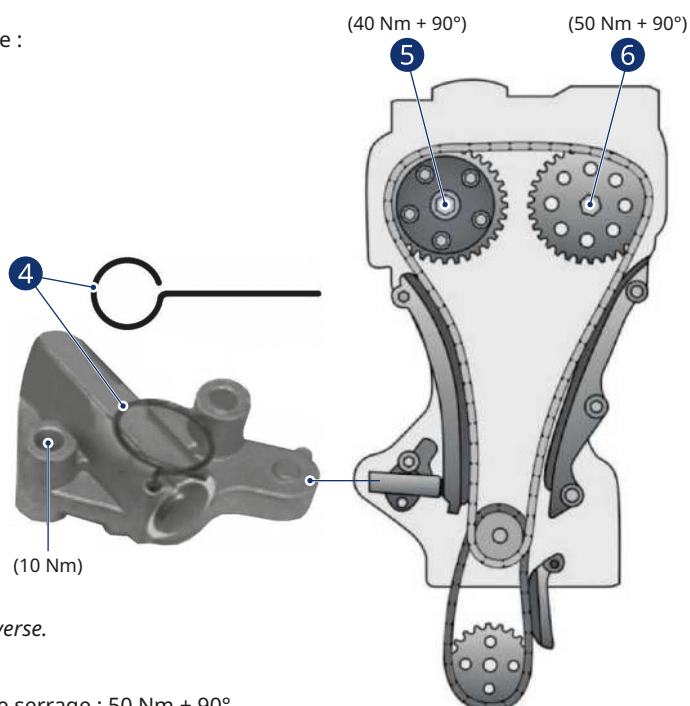
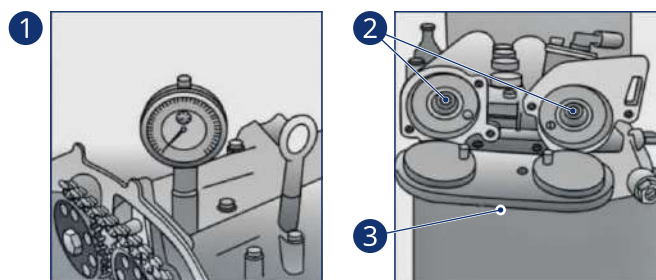

(10 Nm)

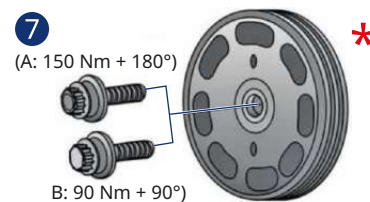

(A: 150 Nm + 180°)

B: 90 Nm + 90°

! Le tendeur de chaîne fourni dans ce kit est à ressort et peut causer des dommages s'il n'est pas manipulé correctement. **NE PAS** retirer la goupille avant qu'elle ne soit complètement installée et assurez-vous toujours que le piston est dirigé loin de vous ou de toute autre personne dans un rayon de 20 mètres.

Les instructions, les recommandations et les informations contenues dans cette publication ont été préparées avec la plus grande attention. Marelli Aftermarket Italy S.p.A., au nom et pour le compte de ses filiales, n'assume aucune responsabilité pour tout type de dommage, même dérivant d'une mauvaise interprétation des informations qui y sont contenues.

* PRÉCISION SUR LE COUPLE DE SERRAGE DES VIS

Le bulletin technique contient les informations suivantes :

- Serrez la vis de poulie d'arbre moteur.
Couple de serrage ⑦ :

- A = 150 Nm + 180°
- B = 90 Nm + 90°.

Deux couples de serrage pour une seule vis. Lequel ?

A

Si, sur le véhicule est installée une **vis combinée dodécaèdre**, à tête alésée, résistance/catégorie 10.9, dimensions M14x1,5x100, OE. : N91048601 comme celle montrée ci-dessous :



Le couple de serrage maximal doit être fixé à : **150 Nm + 180°** (cas A)

B

Si, sur le véhicule est installée une vis différente « **sans tête de vis** », le couple de serrage maximal doit être fixé à : **90 Nm + 90°** (cas B)



VW FSI- und TFSI-Motoren

ANLEITUNG ZUR KORREKTEN IDENTIFIZIERUNG VON REPARATURSÄTZEN

Die Motoren FSI und TFSI der VW Gruppe sind durch eine hohe Komplexität und Komponenten-Variabilität gekennzeichnet, welche die Identifizierung der richtigen Steuerkette als äußerst schwierig gestaltet. Nachfolgend finden Sie ein Schema, das unter Berücksichtigung der am Fahrzeug verbauten Komponenten hilft, das richtige Kit zu identifizieren.

Moteurs VW FSI et TFSI

GUIDE D'IDENTIFICATION DU BON KIT DE RÉPARATION

Les moteurs de type FSI et TFSI du groupe VW se caractérisent par une grande complexité et une grande variabilité des composants qui rendent difficile l'identification du bon kit de réparation / remplacement de la chaîne de distribution. Ci-dessous, un tableau qui, selon les composants installés sur le véhicule, permet d'identifier le bon kit à utiliser.

LEGENDE | LÉGENDE DES SYMBOLES

ANWENDUNGSZEITRAUM DATE DE PRODUCTION	Kompletter Produktionszeitraum Toute la période de production		XXX → XXX Anwendung von Jahr zu Jahr Fabriqué de année à année	
	Automatikgetriebe Transmission automatique		Schaltgetriebe Transmission manuelle	
			DSG-Getriebe Direct-Shift Gearbox (DSG)	
	4WD 4-Rad Antrieb 4 roues motrices (4x4/4WD)		AWD Allradantrieb Traction intégrale (AWD)	
GETRIEBEART TYPE DE TRANSMISSION	FWD Frontantrieb 2 roues motrices (FWD)			
	Ritzel Pignon		Kettenglieder Chaîne	
ANTRIEBSART TYPE DE TRACTION			Kettenspanner Tendeur	
	PRODUKTBESCHREIBUNG DESCRIPTION DES PIÈCES		OE-REFERENZ RÉFÉRENCE OE	
		HINWEIS INFORMATIONS COMPLÉMENTAIRES		
		Fahrgestellnummer Numéro de châssis		
		Motorcode Numéro de moteur		
		→ XXX Von - Bis XXX À XXX		
		XXX → Ab XXX De XXX		
		TEILENUMMER MAGNETI MARELLI RÉFÉRENCES MAGNETI MARELLI		
PARTS		OE		
A1 (8X1, 8XK) 1.4 TFSI		(05/10 → 04/15)		
90 kW		CAXA; CNVA		
Fahrzeug Modèle		Baujahr Année de production		
Motorcode Code moteur		Leistung Puissance du moteur		

Die in dieser Publikation enthaltenen Anweisungen, Empfehlungen und Informationen wurden mit größter Sorgfalt erstellt. Marelli Aftermarket Italy S.p.A. übernimmt im Namen und im Auftrag ihrer Tochtergesellschaften keine Verantwortung für Schäden jeglicher Art, die sich auch aus einer falschen Auslegung der darin enthaltenen Informationen ergeben.

Les instructions, les recommandations et les informations contenues dans cette publication ont été préparées avec la plus grande attention. Marelli Aftermarket Italy S.p.A., au nom et pour le compte de ses filiales, n'assume aucune responsabilité pour tout type de dommage, même dérivant d'une mauvaise interprétation des informations qui y sont contenues.



				PARTS	OE			
							COMPLETE KIT	EASY KIT
AUDI								
A1 (8X1, 8XK) 1.4 TFSI (05/10 → 04/15) CAXA; CNVA 90 kW								
				03C 105 209 AQ	Z = 18/18		MCK1210	MCK1240
				03C 115 225 A	54 Kettenglieder/Maillons			
				03C 109 507 AD				
A1 (8X1, 8XK) 1.4 TFSI (01/11 → 04/15) CAVG; CTHG; CTJA 136 kW								
				03C 105 209 AG	Z = 23/18		MCK1200	MCK1240
				03C 115 225	56 Kettenglieder/Maillons			
				03C 109 507 AF				
A1 Sportback (8XA, 8XF) 1.4 TFSI (11/11 → 04/15) CAXA; CNVA 90 kW								
				03C 105 209 AQ	Z = 18/18		MCK1210	MCK1240
				03C 115 225 A	54 Kettenglieder/Maillons			
				03C 109 507 AD				
A1 Sportback (8XA, 8XF) 1.4 TFSI (11/11 → 04/15) CAVG; CTHG; CTJA 136 kW								
				03C 105 209 AG	Z = 23/18		MCK1200	MCK1240
				03C 115 225	56 Kettenglieder/Maillons			
				03C 109 507 AF				
A3 (8P1) 1.6 FSI (08/03 → 09/07) BAG; BLF; BLP 85 kW								
				03C 105 209 AC / BE	Z = 18/18		MCK0580	MCK1240
				03C 115 230 C	54 Kettenglieder/Maillons			
				03C 109 507 AE / J				
A3 Sportback (8PA) 1.6 FSI (09/04 → 09/07) BLF; BLP 85 kW								
				03C 105 209 AC / BE	Z = 18/18		MCK0580	MCK1240
				03C 115 230 C	54 Kettenglieder/Maillons			
				03C 109 507 AE / J				
A3 (8P1) 1.4 TFSI (09/07 → 08/12) CAXC; CMSA 92 kW								
2007 → 2008				03C 105 209 AK	Z = 23/18; → 30/10/2007		MCK1200	MCK1240
				03C 115 225	56 Kettenglieder/Maillons; → 30/10/2007			
				03C 109 507 AF				
2007 → 2008				03C 105 209 AC / BE	Z = 18/18; 30/10/2007 →		MCK0580	MCK1240
				03C 115 230 C	54 Kettenglieder/Maillons; 30/10/2007 →			
				03C 109 507 AE / J				
2007 → 2008				03C 105 209 AM / BE	Z = 18/18		MCK0580	MCK1240
				03C 115 230 C	54 Kettenglieder/Maillons; → 30/10/2007			
				03C 109 507 AE / J				
2008 → 2012				03C 105 209 AC / BE	Z = 18/18; → 21/07/2008		MCK0580	MCK1240
				03C 115 230 C	54 Kettenglieder/Maillons; → 21/07/2008			
				03C 109 507 AE / J				
				03C 105 209 AQ	Z = 18/18; 21/07/2008 →			
				03C 115 225 A	54 Kettenglieder/Maillons; 21/07/2008 →			
				03C 109 507 AD				



		PARTS	OE		MAGNETI MARELLI PARTS & SERVICES	
					COMPLETE KIT	EASY KIT
AUDI						
A3 Sportback (8PA) 1.4 TFSI (09/07 → 03/13) CAXC; CMSA 92 kW						
2007 → 2008			03C 105 209 AK	Z = 23/18; → 30/10/2007	MCK1200	MCK1240
			03C 115 225	56 Kettenglieder/Maillons; → 30/10/2007		
			03C 109 507 AF			
			03C 105 209 AC / BE	Z = 18/18; 30/10/2007 →	MCK0580	MCK1240
			03C 115 230 C	54 Kettenglieder/Maillons; 30/10/2007 →		
			03C 105 209 AM / BE	Z = 18/18	MCK0580	MCK1240
		03C 115 230 C	54 Kettenglieder/Maillons; → 30/10/2007			
2009 → 2013			03C 105 209 AC / BE	Z = 18/18; → 21/07/2008	MCK0580	MCK1240
			03C 115 230 C	54 Kettenglieder/Maillons; → 21/07/2008		
			03C 109 507 AE / J			
			03C 105 209 AQ	Z = 18/18; 21/07/2008 →	MCK1210	MCK1240
			03C 115 225 A	54 Kettenglieder/Maillons; 21/07/2008 →		
			03C 109 507 AD			
A3 Cabriolet (8P7) 1.4 TFSI (02/11 → 05/13) CAXC 92 kW						
		03C 105 209 AQ / AR	Z = 18/18	MCK1210	MCK1240	
		03C 115 225 A	54 Kettenglieder/Maillons			
		03C 109 507 AD				
SEAT						
ALHAMBRA (710, 711) 1.4 TSI (06/10 →) CAVA; CNWB; CTHA 110 kW						
2011 → 2015			03C 105 209 AR	Z = 18/18	MCK1210	MCK1240
			03C 115 225 A	54 Kettenglieder/Maillons		
			03C 109 507 AD			
ALTEA (5P1) 1.4 TSI (11/07 →) CAXC 92 kW						
2007 → 2010			03C 105 209 AC / BE	Z = 18/18; → 1P-9-023 795	MCK0580	MCK1240
			03C 115 230 C	54 Kettenglieder/Maillons; → 5P-9-011 823		
			03C 109 507 AE / J			
			03C 105 209 AQ	Z = 18/18; 1P-9-023 795 →	MCK1210	MCK1240
			03C 115 225 A	54 Kettenglieder/Maillons; 5P-9-011 823 →		
			03C 109 507 AD			
2011 → 2015			03C 105 209 AQ	Z = 18/18	MCK1210	MCK1240
			03C 115 225 A	54 Kettenglieder/Maillons		
			03C 109 507 AD			
ALTEA XL (5P5, 5P8) 1.4 TSI (11/07 →) CAXC 92 kW						
2007 → 2010			03C 105 209 AC / BE	Z = 18/18; → 1P-9-023 795	MCK0580	MCK1240
			03C 115 230 C	54 Kettenglieder/Maillons; → 5P-9-011 823		
			03C 109 507 AE / J			
			03C 105 209 AQ	Z = 18/18; 1P-9-023 795 →	MCK1210	MCK1240
			03C 115 225 A	54 Kettenglieder/Maillons; 5P-9-011 823 →		
			03C 109 507 AD			
2011 → 2015			03C 105 209 AQ	Z = 18/18	MCK1210	MCK1240
			03C 115 225 A	54 Kettenglieder/Maillons		
			03C 109 507 AD			
CORDOBA (6L2) 1.6 16V (11/06 → 11/09) BTS 77 kW						
		03C 105 209 AC / BE	Z = 18/18	MCK0580	MCK1240	
		03C 115 230 C	54 Kettenglieder/Maillons			
		03C 109 507 AE / J				



		PARTS	OE		COMPLETE KIT	EASY KIT
SEAT						
IBIZA III (6L1) 1.6 16V (11/06 → 11/09) BTS 77 kW						
			03C 105 209 AC / BE	Z = 18/18	MCK0580	MCK1240
			03C 115 230 C	54 Kettenglieder/Maillons		
			03C 109 507 AE / J			
IBIZA IV (6J5, 6P1) 1.6 (05/08 → 03/12) BTS 77 kW						
			03C 105 209 AC / BE	Z = 18/18	MCK0580	MCK1240
			03C 115 230 C	54 Kettenglieder/Maillons		
			03C 109 507 AE / J			
IBIZA IV SPORTCOUPE (6J1, 6P5) 1.6 (07/08 → 05/15) BTS 77 kW						
			03C 105 209 AC / BE	Z = 18/18	MCK0580	MCK1240
			03C 115 230 C	54 Kettenglieder/Maillons		
			03C 109 507 AE / J			
IBIZA IV (6J5, 6P1), IBIZA IV SPORTCOUPE (6J1, 6P5) 1.4 TSI (01/09 → 05/15) CAVF; CNUB; CTHF; CTJB 110 kW						
			03C 105 209 AG	Z = 23/18	MCK1200	MCK1240
			03C 115 225	56 Kettenglieder/Maillons		
			03C 109 507 AF			
IBIZA IV SPORTCOUPE (6J1, 6P5) 1.4 TSI Cupra (06/09 → 05/15) CAVE; CTHE; CTJC 132 kW						
			03C 105 209 AG	Z = 23/18	MCK1200	MCK1240
			03C 115 225	56 Kettenglieder/Maillons		
			03C 109 507 AF			
IBIZA IV (6J5, 6P1); IBIZA IV SPORTCOUPE (6J1, 6P5) 1.6 LPG (05/11 → 05/15) CNKA 60 kW						
			03C 105 209 AC / BE	Z = 18/18	MCK0580	MCK1240
			03C 115 230 C	54 Kettenglieder/Maillons		
			03C 109 507 AE / J			
IBIZA IV ST (6J8, 6P8) 1.4 TSI (02/12 → 05/15) CAVF; CNUB; CTHF; CTJB 110 kW						
			03C 105 209 AG	Z = 23/18	MCK1200	MCK1240
			03C 115 225	56 Kettenglieder/Maillons		
			03C 109 507 AF			
LEON (1P1) 1.4 TSI (11/07 → 12/12) CAXC 92 kW						
2007 → 2010			03C 105 209 AC / BE	Z = 18/18; → 1P-9-023 795	MCK0580	MCK1240
			03C 115 230 C	54 Kettenglieder/Maillons; → 1P-9-023 795		
			03C 109 507 AE / J			
			03C 105 209 AQ	Z = 18/18; 1P-9-023 796 →	MCK1210	MCK1240
			03C 115 225 A	54 Kettenglieder/Maillons; 1P-9-023 796 →		
			03C 109 507 AD			
2011 → 2012			03C 105 209 AQ	Z = 18/18	MCK1210	MCK1240
			03C 115 225 A	54 Kettenglieder/Maillons		
			03C 109 507 AD			
TOLEDO IV (KG3) 1.4 TSI (07/12 → 06/15) CAXA 90 kW						
			03C 105 209 AQ	Z = 18/18	MCK1210	MCK1240
			03C 115 225 A	54 Kettenglieder/Maillons		
			03C 109 507 AD			
TOLEDO IV (KG3) 1.6 (07/13 → 06/15) CFNA 77 kW						
			03C 105 209 AC / BE	Z = 18/18	MCK0580	MCK1240
			03C 115 230 C	54 Kettenglieder/Maillons		
			03C 109 507 AE / J			



				PARTS	OE			
				COMPLETE KIT	EASY KIT			
SKODA								
FABIA II (542); FABIA II Combi (545) 1.6 (04/07 → 12/14) BTS; CFNA 77 kW								
			03C 105 209 AC / BE	Z = 18/18	MCK0580	MCK1240		
			03C 115 230 C	54 Kettenglieder/Maillons				
			03C 109 507 AE / J					
FABIA II (542); FABIA II Combi (545) 1.4 TSI RS (05/10 → 12/14) CAVE; CTHE 132 kW								
			03C 105 209 AG	Z = 23/18	MCK1200	MCK1240		
			03C 115 225	56 Kettenglieder/Maillons				
			03C 109 507 AF					
OCTAVIA II (1Z3); OCTAVIA II Combi (1Z5) 1.6 FSI (02/04 → 10/08) BLF 85 kW								
			03C 105 209 AC / BE	Z = 18/18	MCK0580	MCK1240		
			03C 115 230 C	54 Kettenglieder/Maillons				
			03C 109 507 AE / J					
OCTAVIA II (1Z3); OCTAVIA II Combi (1Z5) 1.4 TSI (11/08 → 06/13) CAXA 90 kW								
			03C 105 209 AQ	Z = 18/18; → 11/05/2015	MCK1210	MCK1240		
			03C 115 225 A	54 Kettenglieder/Maillons				
			03C 109 507 AD					
			03C 105 209 BD	Z = 19/18; 11/05/2015 →	MCK1220	MCK1250		
			03C 115 225 A	54 Kettenglieder/Maillons				
			03C 109 507 AD					
RAPID (NH3); RAPID Spaceback (NH1) 1.4 TSI (07/12 → 06/15) CAXA 90 kW								
			03C 105 209 AQ	Z = 18/18; → 11/05/2015	MCK1210	MCK1240		
			03C 115 225 A	54 Kettenglieder/Maillons				
			03C 109 507 AD					
			03C 105 209 BD	Z = 19/18; 11/05/2015 →	MCK1220	MCK1250		
			03C 115 225 A	54 Kettenglieder/Maillons				
			03C 109 507 AD					
RAPID (NH3); RAPID Spaceback (NH1) 1.6 (07/12 → 06/15) CFNA 77 kW								
			03C 105 209 AC / BE	Z = 18/18	MCK0580	MCK1240		
			03C 115 230 C	54 Kettenglieder/Maillons				
			03C 109 507 AE / J					
ROOMSTER (5J7) 1.6 (09/06 → 05/15) BTS; CFNA 77 kW								
			03C 105 209 AC / BE	Z = 18/18	MCK0580	MCK1240		
			03C 115 230 C	54 Kettenglieder/Maillons				
			03C 109 507 AE / J					
ROOMSTER (5J7) 1.6 LPG (06/06 → 07/10) BTS 77 kW								
			03C 105 209 AC / BE	Z = 18/18	MCK0580	MCK1240		
			03C 115 230 C	54 Kettenglieder/Maillons				
			03C 109 507 AE / J					
SUPERB II (3T4); SUPERB II Station wagon (3T5) 1.4 TSI (07/08 → 05/15) CAXC 92 kW								
2008 → 2013			03C 105 209 AQ	Z = 18/18; → 11/05/2015	MCK1210	MCK1240		
			03C 115 225 A	54 Kettenglieder/Maillons; 01/08/2008 →				
			03C 109 507 AD					
			03C 105 209 BD	Z = 19/18; 11/05/2015 →	MCK1220	MCK1250		
			03C 115 225 A	54 Kettenglieder/Maillons				
			03C 109 507 AD					



				PARTS	OE			
							COMPLETE KIT	EASY KIT
SKODA								
YETI (5L) 1.4 TSI (06/10 → 05/15) CAXA 90 kW								
				03C 105 209 AQ	Z = 18/18; → 11/05/2015			
				03C 115 225 A	54 Kettenglieder/Maillons		MCK1210	MCK1240
				03C 109 507 AD				
				03C 105 209 BD	Z = 19/18; 11/05/2015 →			
				03C 115 225 A	54 Kettenglieder/Maillons		MCK1220	MCK1250
				03C 109 507 AD				
VOLKSWAGEN								
BEETLE (5C1, 5C2; BEETLE Cabriolet (5C7, 5C8) 1.4 TSI (10/11 → 07/16) CAVD; CNWA; CTHD; CTKA 118 kW								
				03C 105 209 AR / AQ	Z = 18/18; → 11/05/2015			
				03C 115 225 A	54 Kettenglieder/Maillons		MCK1210	MCK1240
				03C 109 507 AD				
				03C 105 209 BD	Z = 19/18; 11/05/2015 →			
				03C 115 225 A	54 Kettenglieder/Maillons		MCK1220	MCK1250
				03C 109 507 AD				
CC (358) 1.4 TSI (11/11 → 12/16) CTHD 118 kW								
2012 → 2015								
				03C 105 209 AR / AQ	Z = 18/18; → 24/05/2015			
				03C 115 225 A	54 Kettenglieder/Maillons		MCK1210	MCK1240
				03C 109 507 AD				
				03C 105 209 BD	Z = 19/18; 25/05/2015 →			
				03C 115 225 A	54 Kettenglieder/Maillons		MCK1220	MCK1250
				03C 109 507 AD				
CC (358) 1.4 TSI MultiFuel (11/11 → 12/16) CKMA 118 kW								
2012 → 2015								
				03C 105 209 AR / AQ	Z = 18/18; → 24/05/2015			
				03C 115 225	54 Kettenglieder/Maillons		MCK1210	MCK1240
				03C 109 507 AD				
				03C 105 209 BD	Z = 19/18; 25/05/2015 →			
				03C 115 225A	54 Kettenglieder/Maillons		MCK1220	MCK1250
				03C 109 507 AD				
EOS (1F7, 1F8) 1.6 FSI (06/06 → 05/08) BLF 85 kW								
				03C 105 209 AC / BE	Z = 18/18			
				03C 115 230 C	54 Kettenglieder/Maillons		MCK0580	MCK1240
				03C 109 507 AE / J				
EOS (1F7, 1F8) 1.4 TSI (11/07 → 08/15) CAXA 90 kW								
2007 → 2008								
				03C 105 209 AC / BE	Z = 18/18			
				03C 115 230 C	54 Kettenglieder/Maillons		MCK0580	MCK1240
				03C 109 507 AE / J				
2009 → 2011								
				03C 105 209 AC	Z = 18/18; → 31/07/2008			
				03C 115 230 C	54 Kettenglieder/Maillons; → 31/07/2008		MCK0580	MCK1240
				03C 109 507 AE / J				
				03C 105 209 AQ	Z = 18/18; 01/08/2008 →			
				03C 115 225 A	54 Kettenglieder/Maillons; 01/08/2008 →		MCK1210	MCK1240
				03C 109 507 AD				
2012 → 2015								
				03C 105 209 AR / AQ	Z = 18/18; → 24/05/2015			
				03C 115 225 A	54 Kettenglieder/Maillons		MCK1210	MCK1240
				03C 109 507 AD				
				03C 105 209 BD	Z = 19/18; 25/05/2015 →			
				03C 115 225 A	54 Kettenglieder/Maillons		MCK1220	MCK1250
				03C 109 507 AD				



				PARTS	OE			COMPLETE KIT	EASY KIT	
VOLKSWAGEN										
EOS (1F7, 1F8) 1.4 TSI → 05/2015 (05/08 → 08/15) CAVD; CTHD 118 kW										
2009 → 2011				03C 105 209 AG	Z = 23/18; → 30/06/2008			MCK1200	MCK1240	
				03C 115 225	56 Kettenglieder/Maillons; → 30/06/2008					
				03C 109 507 AF						
				03C 105 209 AR / AQ	Z = 18/18; 01/07/2008 →					
				03C 115 225 A	54 Kettenglieder/Maillons; 01/07/2008 →					
2011 → 2015				03C 105 209 AR / AQ	Z = 18/18; → 24/05/2015			MCK0580	MCK1240	
				03C 115 225 A	54 Kettenglieder/Maillons					
				03C 109 507 AD						
				03C 105 209 BD	Z = 19/18; 25/05/2015 →					
				03C 115 225 A	54 Kettenglieder/Maillons					
GOLF PLUS (5M1, 521) 1.6 FSI (12/04 → 05/08) BLF 85 kW				03C 105 209 AC / BE	Z = 18/18			MCK0580	MCK1240	
				03C 115 230 C	54 Kettenglieder/Maillons					
				03C 109 507 AE / J						
GOLF PLUS (5M1, 521) 1.4 FSI (07/05 → 11/06) BLN 66 kW				03C 105 209 AC / BE	Z = 18/18			MCK0580	MCK1240	
				03C 115 230 C	54 Kettenglieder/Maillons					
				03C 109 507 AE / J						
GOLF PLUS (5M1, 521) 1.4 TSI (05/06 → 06/08) BMY; BLG 103; 125 kW				03C 105 209 AG	Z = 23/18			MCK1200	MCK1240	
				03C 115 225	56 Kettenglieder/Maillons					
				03C 109 507 AF						
GOLF PLUS (5M1, 521) 1.4 TSI (06/07 → 12/13) CAXA 90 kW	2008 → 2009				03C 105 209 AK / AG	Z = 23/18; → 1K-8-546 000			MCK1200	MCK1240
					03C 115 225	56 Kettenglieder/Maillons; → 1K-8-546 000				
					03C 109 507 AF					
				03C 105 209 AC / BE	Z = 18/18; 1K-8-546 001 → 1K-9-825 000			MCK0580	MCK1240	
				03C 115 230 C	54 Kettenglieder/Maillons; 1K-8-546 001 → 1K-9-825 000					
				03C 109 507 AE / J						
				03C 105 209 AQ	Z = 18/18; 1K-9-825 001 →			MCK1210	MCK1240	
				03C 115 225 A	54 Kettenglieder/Maillons; 1K-9-825 001 →					
				03C 109 507 AD						
				03C 105 209 AC / BE	Z = 18/18; → 1K-9-825 000			MCK0580	MCK1240	
				03C 115 230 C	→ 1K-9-825 000					
				03C 109 507 AE / J						
				03C 105 209 AQ	Z = 18/18; 1K-9-825 001 →			MCK1210	MCK1240	
				03C 115 225 A	1K-9-825 001 →					
				03C 109 507 AD						
2009 → 2013				03C 105 209 AQ	Z = 18/18			MCK1210	MCK1240	
				03C 115 225 A	54 Kettenglieder/Maillons					
				03C 109 507 AD						



		PARTS		OE				MAGNETI MARELLI PARTS & SERVICES		
								COMPLETE KIT	EASY KIT	
VOLKSWAGEN										
GOLF PLUS (5M1, 521) 1.4 TSI (06/08 → 12/13) CAVD; CNWA; CTHD 118 kW										
			03C 105 209 AR / AQ	Z = 18/18	MCK1210	MCK1240				
			03C 115 225 A	54 Kettenglieder/Maillons						
			03C 109 507 AD							
GOLF V (1K1) 1.4 FSI (10/03 → 07/06) BKG; BLN 66 kW										
			03C 105 209 AC / BE	Z = 18/18	MCK0580	MCK1240				
			03C 115 230 C	54 Kettenglieder/Maillons						
			03C 109 507 AE / J							
GOLF V (1K1) 1.6 FSI (10/03 → 07/08) BAG; BLF; BLP 85 kW										
			03C 105 209 AC / BE	Z = 18/18	MCK0580	MCK1240				
			03C 115 230 C	54 Kettenglieder/Maillons						
			03C 109 507 AE / J							
GOLF V (1K1) 1.4 TSI (05/07 → 11/08) CAXA 90 kW										
			03C 105 209 AK / AG	Z = 23/18; → 1K-8P050 000, → 1K-8U010 000, → 1K-8W150 000	MCK1200	MCK1240				
			03C 115 225	56 Kettenglieder/Maillons						
			03C 109 507 AF							
			03C 105 209 AC / BE	Z = 18/18; 1K-8P050 001 →, → 1K-9P025 000, 1K-8U010 001 →, → 1K-9U008 000, 1K-8W150 001 →, → 1K-9W090 000	MCK0580	MCK1240				
			03C 115 230 C	54 Kettenglieder/Maillons						
			03C 109 507 AE / J							
			03C 105 209 AQ	Z = 18/18; 1K-9P025 001 →, 1K-9U008 001 →, 1K-9W090 001 →	MCK1210	MCK1240				
			03C 115 225 A	54 Kettenglieder/Maillons						
			03C 109 507 AD							
			03C 105 209 AC / BE	Z = 18/18; → 1K-9P025 000, → 1K-9U008 000, → 1K-9W090 000	MCK0580	MCK1240				
			03C 115 230 C	54 Kettenglieder/Maillons						
			03C 109 507 AE / J							
			03C 105 209 AQ	Z = 18/18; 1K-9P025 001 →, 1K-9U008 001 →, 1K-9W090 001 →	MCK1210	MCK1240				
			03C 115 225 A	54 Kettenglieder/Maillons						
			03C 109 507 AD							
	GOLF V Variant (1K5) 1.4 TSI (06/07 → 07/09) CAXA 90 kW									
				03C 105 209 AK / AG	Z = 23/18; → 31/10/2007	MCK1200	MCK1240			
				03C 115 225	56 Kettenglieder/Maillons					
				03C 109 507 AF						
				03C 105 209 AC / BE	Z = 18/18; 01/11/2007 → 31/07/2008	MCK0580	MCK1240			
				03C 115 230 C	54 Kettenglieder/Maillons					
			03C 109 507 AE / J							
			03C 105 209 AQ	Z = 18/18; 01/08/2008 → 31/06/2009	MCK1210	MCK1240				
			03C 115 225 A	54 Kettenglieder/Maillons						
			03C 109 507 AD							



**MAGNETI
MARELLI**

PARTS & SERVICES

		PARTS	OE			COMPLETE KIT	EASY KIT
VOLKSWAGEN							
GOLF VI (5K1) 1.4 TSI (10/08 → 11/12) CAXA 90 kW							
2008 → 2009			03C 105 209 AK / AG	Z = 23/18; → 1K-8P050 000, → 1K-8U010 000, → 1K-8W150 000	MCK1200	MCK1240	
			03C 115 225	56 Kettenglieder/Maillons			
			03C 109 507 AF				
			03C 105 209 AC / BE	Z = 18/18; 1K-8P050 001 →, → 1K-9P025 000, 1K-8U010 001 →, → 1K-9U008 000, 1K-8W150 001 →, → 1K-9W090 000	MCK0580	MCK1240	
			03C 115 230 C	54 Kettenglieder/Maillons			
			03C 109 507 AE / J				
			03C 105 209 AQ	Z = 18/18; 1K-9P025 001 →, 1K-9U008 001 →, 1K-9W090 001 →	MCK1210	MCK1240	
			03C 115 225 A	54 Kettenglieder/Maillons			
			03C 109 507 AD				
			03C 105 209 AC / BE	Z = 18/18; → 1K-9P025 000, → 1K-9U008 000, → 1K-9W090 000	MCK0580	MCK1240	
			03C 115 230 C	54 Kettenglieder/Maillons			
			03C 109 507 AE / J				
			03C 105 209 AQ	Z = 18/18; 1K-9P025 001 →, 1K-9U008 001 →, 1K-9W090 001 →	MCK1210	MCK1240	
			03C 115 225 A	54 Kettenglieder/Maillons			
			03C 109 507 AD				
2009 → 2012		03C 105 209 AQ	Z = 18/18	MCK1210	MCK1240		
		03C 115 225 A	54 Kettenglieder/Maillons				
		03C 109 507 AD					
GOLF VI (5K1) 1.4 TSI (10/08 → 11/12) CAVD; CNWA; CTHD 118 kW							
		03C 105 209 AQ / AR	Z = 18/18	MCK1210	MCK1240		
		03C 115 225 A	54 Kettenglieder/Maillons				
		03C 109 507 AD					
GOLF VI Cabriolet (517) 1.4 TSI (03/11 → 05/16) CAVD; CNWA; CTHD; CTKA 118 kW							
		03C 105 209 AR / AQ	Z = 18/18; → 24/05/2015	MCK1210	MCK1240		
		03C 115 225 A	54 Kettenglieder/Maillons				
		03C 109 507 AD					
		03C 105 209 BD	Z = 19/18; 25/05/2015 →	MCK1220	MCK1250		
		03C 115 225 A	54 Kettenglieder/Maillons				
	03C 109 507 AD						
GOLF VI Cabriolet (517) 1.4 TSI (11/11 → 05/16) CAXA 90 kW							
		03C 105 209 AR / AQ	Z = 18/18; → 24/05/2015	MCK1210	MCK1240		
		03C 115 225 A	54 Kettenglieder/Maillons				
		03C 109 507 AD					
		03C 105 209 BD	Z = 19/18; 25/05/2015 →	MCK1220	MCK1250		
		03C 115 225 A	54 Kettenglieder/Maillons				
	03C 109 507 AD						
JETTA III (1K2) 1.6 FSI (09/05 → 10/10) BLF 85 kW							
		03C 105 209 AC / BE	Z = 18/18	MCK0580	MCK1240		
		03C 115 230 C	54 Kettenglieder/Maillons				
		03C 109 507 AE / J					
JETTA III (1K2) 1.4 TSI (07/06 → 10/10) BMY; BLG 103; 125 kW							
		03C 105 209 AG	Z = 23/18	MCK1200	MCK1240		
		03C 115 225	56 Kettenglieder/Maillons				
		03C 109 507 AF					



		PARTS	OE		MAGNETI MARELLI PARTS & SERVICES			
					COMPLETE KIT	EASY KIT		
VOLKSWAGEN								
JETTA III (1K2) 1.4 TSI (05/07 → 10/10) CAXA 90 kW								
2007 → 2008			03C 105 209 AK / AG	Z = 23/18	MCK1200	MCK1240		
			03C 115 225	56 Kettenglieder/Maillons				
			03C 109 507 AF					
			03C 105 209 AC / BE	Z = 18/18	MCK0580	MCK1240		
			03C 115 230 C	54 Kettenglieder/Maillons				
			03C 109 507 AE / J					
2009 → 2010			03C 105 209 AC	Z = 18/18; → 31/07/2008	MCK0580	MCK1240		
			03C 115 230 C	54 Kettenglieder/Maillons				
			03C 109 507 AE / J					
					03C 105 209 AQ	Z = 18/18; 01/08/2008 →	MCK1210	MCK1240
					03C 115 225 A	54 Kettenglieder/Maillons		
			03C 109 507 AD					
JETTA IV (162, 163, AV3, AV2) 1.4 TSI (05/11 →) CAXA; CMSB; CAVA; CTHA; CAVD; CTHD 90; 110; 118 kW								
2011 → 2014			03C 105 209 AQ / AR	Z = 18/18	MCK1210	MCK1240		
			03C 115 225 A	54 Kettenglieder/Maillons				
			03C 109 507 AD					
2015 → 2018			03C 105 209 AR / AQ	Z = 18/18; → 11/05/2015	MCK1210	MCK1240		
			03C 115 225 A	54 Kettenglieder/Maillons				
			03C 109 507 AD					
					03C 105 209 BD	Z = 19/18; 12/05/2015 →	MCK1220	MCK1250
					03C 115 225 A	54 Kettenglieder/Maillons		
			03C 109 507 AD					
JETTA IV (162, 163, AV3, AV2) 1.6 (12/11 →) CFNA; CLRA 77 kW								
			03C 105 209 AC / BE	Z = 18/18	MCK0580	MCK1240		
			03C 115 230 C	54 Kettenglieder/Maillons				
			03C 109 507 AE / J					
PASSAT (3C2) 1.6 FSI (03/05 → 06/08) BLF 85 kW								
			03C 105 209 AC / BE	Z 18/18	MCK0580	MCK1240		
			03C 115 230 C	54 Kettenglieder/Maillons				
			03C 109 507 J / AE					
PASSAT (3C2) 1.4 TSI (05/07 → 07/10) CAXA 90 kW								
2007 → 2008			03C 105 209 AK	Z = 23/18; → 3C-8E110 000, → 3C-8P060 000	MCK1200	MCK1240		
			03C 115 225	56 Kettenglieder/Maillons				
					03C 109 507 AB/ AF			
					03C 105 209 AC / BE	Z = 18/18; 3C-8E110 001 →, 3C-8P060 001 →	MCK0580	MCK1240
					03C 115 230 C	54 Kettenglieder/Maillons		
			03C 109 507 AE					
2009 → 2010			03C 105 209 AC / BE	Z = 18/18; → 31/07/2008	MCK0580	MCK1240		
			03C 115 230 C	54 Kettenglieder/Maillons				
			03C 109 507 AE					
					03C 105 209 AQ	Z = 18/18; 01/08/2008 →	MCK1210	MCK1240
					03C 115 225 A	54 Kettenglieder/Maillons		
			03C 109 507 AD					
PASSAT (3C2) 1.4 TSI EcoFuel (01/09 → 07/10) CDGA 110 kW								
			03C 105 209 AG	Z = 23/18	MCK1200	MCK1240		
			03C 115 225	56 Kettenglieder/Maillons				
			03C 109 507 AF					



				PARTS	OE			COMPLETE KIT	EASY KIT
VOLKSWAGEN									
*	PASSAT (362) 1.4 TSI	(08/10 → 12/14)		CAXA	90 kW				
	2010 → 2011			03C 105 209 AC / BE	Z = 18/18; → 31/07/2008				
				03C 115 230 C	54 Kettenglieder/Maillons		MCK0580	MCK1240	
				03C 109 507 AE / J					
				03C 105 209 AQ	Z = 18/18; 01/08/2008 →				
				03C 115 225 A	54 Kettenglieder/Maillons		MCK1210	MCK1240	
				03C 109 507 AD					
	2012 → 2014			03C 105 209 AQ	Z = 18/18				
				03C 115 225 A	54 Kettenglieder/Maillons		MCK1210	MCK1240	
				03C 109 507 AD					
*	PASSAT (362) 1.4 TSI EcoFuel	(08/10 → 12/14)		CDGA	110 kW				
				03C 105 209 AG	Z = 23/18				
				03C 115 225	56 Kettenglieder/Maillons		MCK1200	MCK1240	
				03C 109 507 AF					
*	PASSAT (362) 1.4 TSI MultiFuel	(11/10 → 12/14)		CKMA	118 kW				
				03C 105 209 AG	Z = 23/18				
				03C 115 225	56 Kettenglieder/Maillons		MCK1200	MCK1240	
				03C 109 507 AF					
*	PASSAT (362) 1.4 TSI	(11/12 → 12/14)		CTHD	118 kW				
				03C 105 209 AG	Z = 23/18				
				03C 115 225	56 Kettenglieder/Maillons		MCK1200	MCK1240	
				03C 109 507 AF					
	PASSAT CC (357) 1.4 TSI MultiFuel	(01/11 → 01/12)		CKMA	118 kW				
				03C 105 209 AG	Z = 23/18				
				03C 115 225	56 Kettenglieder/Maillons		MCK1200	MCK1240	
				03C 109 507 AF					
	PASSAT Variant (3C5) 1.6 FSI	(08/05 → 06/08)		BLF	85 kW				
				03C 105 209 AC / BE	Z = 18/18				
				03C 115 230 C	54 Kettenglieder/Maillons		MCK0580	MCK1240	
				03C 109 507 J / AE					
	PASSAT Variant (3C5) 1.4 TSI	(05/07 → 11/10)		CAXA	90 kW				
	2007 → 2008			03C 105 209 AK	Z = 23/18; → 3C-8E110 000, → 3C-8P060 000				
				03C 115 225	56 Kettenglieder/Maillons		MCK1200	MCK1240	
				03C 109 507 AB/ AF					
				03C 105 209 AC / BE	Z = 18/18; 3C-8E110 001 →, 3C-8P060 001 →				
				03C 115 230 C	54 Kettenglieder/Maillons		MCK0580	MCK1240	
				03C 109 507 AE					
	2009 → 2010			03C 105 209 AC / BE	Z = 18/18; → 31/07/2008				
				03C 115 230 C	54 Kettenglieder/Maillons		MCK0580	MCK1240	
				03C 109 507 AE					
				03C 105 209 AQ	Z = 18/18; 01/08/2008 →				
				03C 115 225 A	54 Kettenglieder/Maillons		MCK1210	MCK1240	
				03C 109 507 AD					
	PASSAT Variant (3C5) 1.4 TSI EcoFuel	(01/09 → 11/10)		CDGA	110 kW				
				03C 105 209 AG	Z = 23/18				
				03C 115 225	56 Kettenglieder/Maillons		MCK1200	MCK1240	
				03C 109 507 AF					



		PARTS	OE			COMPLETE KIT	EASY KIT
VOLKSWAGEN							
* PASSAT Variant (365) 1.4 TSI (08/10 → 12/14) CAXA 90 kW							
2010 → 2011			03C 105 209 AC / BE	Z 18/18; → 31/07/2008		MCK0580	MCK1240
			03C 115 230 C	54 Kettenglieder/Maillons			
			03C 109 507 AE				
			03C 105 209 AQ	Z = 18/18; 01/08/2008 →			
			03C 115 225 A	54 Kettenglieder/Maillons			
2011 → 2014			03C 109 507 AD			MCK120	MCK1240
			03C 105 209 AQ	Z = 18/18; 01/08/2008 →			
			03C 115 225 A	54 Kettenglieder/Maillons			
* PASSAT Variant (365) 1.4 TSI EcoFuel (08/10 → 12/14) CDGA 110 kW							
			03C 105 209 AG	Z = 23/18		MCK1200	MCK1240
			03C 115 225	56 Kettenglieder/Maillons			
			03C 109 507 AF				
* PASSAT Variant (365) 1.4 TSI MultiFuel (11/10 → 12/14) CKMA 118 kW							
			03C 105 209 AG	Z = 23/18		MCK1200	MCK1240
			03C 115 225	56 Kettenglieder/Maillons			
			03C 109 507 AF				
* PASSAT Variant (365) 1.4 TSI (11/12 → 12/14) CTHD 118 kW							
			03C 105 209 AG	Z = 23/18		MCK1200	MCK1240
			03C 115 225	56 Kettenglieder/Maillons			
			03C 109 507 AF				
POLO (9N_) 1.4 FSI (02/02 → 07/06) AXU 63 kW							
			03C 105 209 AC / BE	Z = 18/18		MCK0580	MCK1240
			03C 115 230 C	54 Kettenglieder/Maillons			
			03C 109 507 AE				
POLO (9N_) 1.6 16V (05/06 → 11/09) BTS 77 kW							
			03C 105 209 AC / BE	Z = 18/18		MCK0580	MCK1240
			03C 115 230 C	54 Kettenglieder/Maillons			
			03C 109 507 AE				
POLO (6R1, 6C1) 1.4 (6R1) (03/09 → 05/14) ; CLPA 63 kW							
			03C 105 209 AC / BE	Z = 18/18		MCK0580	MCK1240
			03C 115 230 C	54 Kettenglieder/Maillons			
			03C 109 507 AE				
POLO (6R1, 6C1) 1.4 GTI (05/10 →) CAVE; CTHE 132 kW							
			03C 105 209 AG	Z = 23/18		MCK1200	MCK1240
			03C 115 225	56 Kettenglieder/Maillons			
			03C 109 507 AF				
POLO (6R1, 6C1) 1.6 BiFuel (01/11 →) CNKA 60 kW							
			03C 105 209 AC / BE	Z = 18/18		MCK0580	MCK1240
			03C 115 230 C	54 Kettenglieder/Maillons			
			03C 109 507 AE				



		PARTS	OE		COMPLETE KIT	EASY KIT
VOLKSWAGEN						
SCIROCCO (137, 138) 1.4 TSI (08/08 → 11/17) CAXA; CMSB 90 kW						
2008 → 2015		03C 105 209 AQ	Z = 18/18			
		03C 115 225 A	54 Kettenglieder/Maillons		MCK1210	MCK1240
		03C 109 507 AD				
2015 → 2018		03C 105 209 AQ	Z = 18/18; → 24/05/2015			
		03C 115 225 A	54 Kettenglieder/Maillons		MCK1210	MCK1240
		03C 109 507 AD				
		03C 105 209 BD	Z = 19/18; 25/05/2015 →			
		03C 115 225 A	54 Kettenglieder/Maillons		MCK1220	MCK1250
		03C 109 507 AD				
SCIROCCO (137, 138) 1.4 TSI (05/08 → 11/17) CAVD; CNWA; CTHD; CTKA 118 kW						
2008 → 2014		03C 105 209 AG	Z = 23/18; → 30/06/2008			
		03C 115 225	56 Kettenglieder/Maillons		MCK1200	MCK1240
		03C 109 507 AF				
		03C 105 209 AR / AQ	Z = 18/18; 01/07/2008 →			
		03C 115 225 A	54 Kettenglieder/Maillons		MCK1210	MCK1240
2015 → 2018		03C 105 209 AQ	Z = 18/18; → 24/05/2015			
		03C 115 225 A	54 Kettenglieder/Maillons		MCK1210	MCK1240
		03C 109 507 AD				
		03C 105 209 BD	Z = 19/18; 25/05/2015 →			
		03C 115 225 A	54 Kettenglieder/Maillons		MCK1220	MCK1250
		03C 109 507 AD				
SHARAN (7N1, 7N2) 1.4 TSI (05/10 →) CAVA; CNWB; CTHA 110 kW						
2010 → 2016		03C 105 209 AR	Z = 18/18; → 24/05/2015			
		03C 115 225 A	54 Kettenglieder/Maillons		MCK1210	MCK1240
		03C 109 507 AD				
		03C 105 209 BD	Z = 19/18; 25/05/2015 →			
		03C 115 225 A	54 Kettenglieder/Maillons		MCK1220	MCK1250
2010 → 2011		03C 109 507 AD				
		03C 105 209 AR / AQ	Z = 18/18; → 24/05/2015			
		03C 115 225 A	54 Kettenglieder/Maillons		MCK1210	MCK1240
		03C 109 507 AD				
		03C 105 209 BD	Z = 19/18; 25/05/2015 →			
		03C 115 225 A	54 Kettenglieder/Maillons		MCK1220	MCK1250
TIGUAN (5N_) 1.4 TSI (08/10 → 07/18) CAXA 90 kW						
2010 → 2011		03C 105 209 AQ	Z = 18/18			
		03C 115 225 A	54 Kettenglieder/Maillons		MCK1210	MCK1240
		03C 109 507 AD				
2010 → 2011		03C 105 209 AR / AQ	Z = 18/18; → 24/05/2015			
		03C 115 225 A	54 Kettenglieder/Maillons		MCK1210	MCK1240
		03C 109 507 AD				
		03C 105 209 BD	Z = 19/18; 25/05/2015 →			
		03C 115 225 A	54 Kettenglieder/Maillons		MCK1220	MCK1250
		03C 109 507 AD				



**MAGNETI
MARELLI**

PARTS & SERVICES

				PARTS	OE			
							COMPLETE KIT	EASY KIT
VOLKSWAGEN								
TIGUAN (5N_) 1.4 TSI 4motion (09/07 → 07/18) BWK; CAVA; CTHA 110 kW								
2008 → 2011	AWD/4WD		03C 105 209 AG	Z = 23/18; → 02/11/2008				
			03C 115 225	56 Kettenglieder/Maillons		MCK1200	MCK1240	
			03C 109 507 AF					
			03C 105 209 AR	Z = 18/18; 03/11/2008 →				
			03C 115 225 A	54 Kettenglieder/Maillons		MCK1210	MCK1240	
			03C 109 507 AD					
2012 → 2018			03C 105 209 AR / AQ	Z = 18/18; → 24/05/2015				
			03C 115 225 A	54 Kettenglieder/Maillons		MCK1210	MCK1240	
			03C 109 507 AD					
			03C 105 209 BD	Z = 19/18; 25/05/2015 →				
			03C 115 225 A	54 Kettenglieder/Maillons		MCK1220	MCK1250	
			03C 109 507 AD					
TIGUAN (5N_) 1.4 TSI (05/08 → 07/18) CAVA, CTHA 110 kW								
2008 → 2011	AWD/4WD		03C 105 209 AG	Z = 23/18; → 02/11/2008 (4 motion)				
			03C 115 225	56 Kettenglieder/Maillons		MCK1200	MCK1240	
			03C 109 507 AF					
	FWD		03C 105 209 AR	Z = 18/18; → 02/11/2008 (FWD)				
			03C 115 225 A	54 Kettenglieder/Maillons		MCK1210	MCK1240	
			03C 109 507 AD					
2012 → 2018			03C 105 209 AR / AQ	Z = 18/18; → 24/05/2015				
			03C 115 225 A	54 Kettenglieder/Maillons		MCK1210	MCK1240	
			03C 109 507 AD					
			03C 105 209 BD	Z = 19/18; 25/05/2015 →				
			03C 115 225 A	54 Kettenglieder/Maillons		MCK1220	MCK1250	
			03C 109 507 AD					
TIGUAN (5N_) 1.4 TSI; 1.4 TSI 4motion (05/11 → 07/18) CAVD; CTHD 118 kW								
			03C 105 209 AR / AQ	Z = 18/18; → 24/05/2015				
			03C 115 225 A	54 Kettenglieder/Maillons		MCK1210	MCK1240	
			03C 109 507 AD					
			03C 105 209 BD	Z = 19/18; 25/05/2015 →				
			03C 115 225 A	54 Kettenglieder/Maillons		MCK1220	MCK1250	
			03C 109 507 AD					
TOURAN (1T1, 1T2) 1.6 FSI (02/03 → 01/07) BAG; BLF; BLP 85 kW								
			03C 105 209 AC / BE	Z = 18/18				
			03C 115 230 C	56 Kettenglieder/Maillons		MCK0580	MCK1240	
			03C 109 507 J / AE					
TOURAN (1T1, 1T2) 1.4 TSI (02/06 → 05/10) BMY; CAVC 103 kW								
2006 → 2008			03C 105 209 AF / AG	Z = 23/18				
			03C 115 225	56 Kettenglieder/Maillons		MCK1200	MCK1240	
			03C 109 507 AF					
2009 → 2010			03C 105 209 AF / AG	Z = 23/18; → 1T-9-150 000				
			03C 115 225	56 Kettenglieder/Maillons		MCK1200	MCK1240	
			03C 109 507 AF					
			03C 105 209 AR	Z = 18/18; 1T-9-150 001 →				
			03C 115 225 A	54 Kettenglieder/Maillons		MCK1210	MCK1240	
			03C 109 507 AD					



			PARTS	OE			
						COMPLETE KIT	EASY KIT
VOLKSWAGEN							
TOURAN (1T1, 1T2) 1.4 FSI (11/06 → 05/10) BLG; CAVB 125 kW							
2006 → 2008			03C 105 209 AF / AG	Z = 23/18		MCK1200	MCK1240
			03C 115 225	56 Kettenglieder/Maillons			
			03C 109 507 AF				
2009 → 2010			03C 105 209 AF / AG	Z = 23/18; → 1T-9-150 000		MCK1200	MCK1240
			03C 115 225	56 Kettenglieder/Maillons			
			03C 109 507 AF				
			03C 105 209 AR	Z = 18/18; 1T-9-150 001 →		MCK1210	MCK1240
			03C 115 225 A	54 Kettenglieder/Maillons			
			03C 109 507 AD				
TOURAN (1T1, 1T2) 1.4 TSI EcoFuel (05/09 → 05/10) CDGA 110 kW							
			03C 105 209 AG	Z = 23/18		MCK1200	MCK1240
			03C 115 225	56 Kettenglieder/Maillons			
			03C 109 507 AF				
TOURAN (1T3) 1.4 TSI (05/10 → 05/15) CAVC; CTHC 103 kW							
2010			03C 105 209 AF / AG	Z = 23/18; → 1T-9-150 000		MCK1200	MCK1240
			03C 115 225	56 Kettenglieder/Maillons			
			03C 109 507 AF				
			03C 105 209 AR	Z = 18/18; 1T-9-150 001 →		MCK1210	MCK1240
			03C 115 225 A	54 Kettenglieder/Maillons			
			03C 109 507 AD				
2011 → 2015			03C 105 209 AR	Z = 18/18		MCK1210	MCK1240
			03C 115 225 A	54 Kettenglieder/Maillons			
			3C 109 507 AD				
TOURAN (1T3) 1.4 TSI (05/10 → 05/15) CAVB; CTHB 125 kW							
2010			03C 105 209 AF / AG	Z = 23/18; → 1T-9-150 000		MCK1200	MCK1240
			03C 115 225	56 Kettenglieder/Maillons			
			03C 109 507 AF				
			03C 105 209 AR	Z = 18/18; 1T-9-150 001 →		MCK1210	MCK1240
			03C 115 225 A	54 Kettenglieder/Maillons			
			03C 109 507 AD				
2011 → 2015			03C 105 209 AR	Z = 18/18		MCK1210	MCK1240
			03C 115 225 A	54 Kettenglieder/Maillons			
			3C 109 507 AD				
TOURAN (1T3) 1.4 TSI EcoFuel (05/10 → 05/15) CDGA 110 kW							
			03C 105 209 AG	Z = 23/18		MCK1200	MCK1240
			03C 115 225	56 Kettenglieder/Maillons			
			03C 109 507 AF				



* Die Fahrzeuge **VOLKSWAGEN PASSAT (362) 1.4 TSI**, produziert von 08/2010 bis 12/2014 und **VOLKSWAGEN PASSAT Variant (365) 1.4 TSI**, produziert von 08/2010 bis 12/2014, die im Zweijahreszeitraum 2010-2011 gebaut wurden, liegen in dem Generationswechsel von der sechsten (B6) zur siebten (B7) Generation.

Laut dem OE-Programm, könnte eine Ritzel - Kurbelwellen Konfiguration der vorherigen Generation installiert sein.

Bei diesen Fahrzeugen ist die Wahl des richtigen Steuerketzensatzes abhängig von dem Baujahr und Monat der Produktion, was keine einfache Aufgabe ist, da es möglich ist, dass sich dies vom Zulassungsjahr im Fahrzeugschein unterscheiden kann.

Nachfolgend finden Sie eine zusätzliche Einschränkungstabelle die zu berücksichtigen ist:

*Les véhicules **VOLKSWAGEN PASSAT (362) 1.4 TSI**, fabriqués à partir de 08/2010 à 12/2014 et **VOLKSWAGEN PASSAT Variant (365) 1.4 TSI**, fabriqués à partir de 08/2010 à 12/2014, assemblés au cours de la période 2010-2011, sont au cœur du changement de génération, qui passe de la sixième (B6) à la septième (B7).*

Pour cette raison, selon les références OE, la configuration pignon-vilebrequin installée pourrait être celle de la génération précédente.

Sur ces véhicules, le choix du bon kit de chaîne de distribution est lié à l'identification du mois et de l'année de production, ce qui n'est pas évident (elle peut être différente de la date de mise en circulation inscrite sur la carte grise du véhicule).

Voici ci-dessous un tableau des informations supplémentaires à prendre en compte :

		KOMPONENTEN COMPOSANTS	OE		MAGNETI MARELLI PARTS & SERVICES	
					COMPLETE KIT	EASY KIT
→ 2009 (D>>-MJ 2009)		Ritzel Pignon	03C 105 209 AC / BE	Z =18/18; → 31/07/2008	MCK0580	MCK1240
		Kurbelwelle Vilebrequin	03C 105 101 BF/BM			
		Axial Lager Palier de butée	06B 105 313 D			
		Ritzel Pignon	03C 105 209 AQ	Z =18/18; 01/08/2008 →	MCK1210	MCK1240
		Kurbelwelle Vilebrequin	03C 105 101 BF/BM			
		Axial Lager Palier de butée	06B 105 313 D			
2010 (D-MJ 2010>>>) → 2012		Ritzel Pignon	03C 105 209 AQ	Z = 18/18	MCK1210	MCK1240
		Kurbelwelle Vilebrequin	03C 105 101 BF/BM			
		Axial Lager Palier de butée	06B 105 313 D			
2012 →		Ritzel Pignon	03C 105 209 AQ	Z = 18/18	MCK1210	MCK1240
		Kurbelwelle Vilebrequin	03C 105 101 BM			
		Axial Lager Palier de butée	06B 105 313 D			

In Anbetracht all dieser verschiedenen Variablen empfehlen wir dringend anhand der OE-Referenzen die am Fahrzeug verbauten Komponenten zu überprüfen, um den richtigen Steuerketten Ersatz zu identifizieren.

Compte tenu de toutes ces différentes variables, nous vous recommandons fortement de vérifier, grâce aux références OE, les composants installés sur le véhicule, afin d'identifier le bon kit de remplacement de chaîne de distribution.



Fahrzeugproduktionsjahre | *Années de production du véhicule*

**MAGNETI
MARELLI**

PARTS & SERVICES

Joint d'étanchéité FPM et PTFE

INSTRUCTIONS ET PRÉCAUTIONS POUR UNE BONNE INSTALLATION

Les kits chaîne Magneti Marelli Parts & Services comprennent deux types de joint d'étanchéité : le premier en **FPM** (caoutchouc fluoré) et le second en **PTFE** (polytétrafluoréthylène).

Les deux joints d'étanchéité diffèrent non seulement par le matériau dans lequel ils sont fabriqués, mais également par la méthode d'installation qui doit être suivie, tout en prenant en compte les précautions nécessaires.

Joint d'étanchéité FPM (caoutchouc fluoré)

Caractéristiques

- Ces joints d'étanchéité sont considérés comme étant de type « traditionnel »,
- Ils créent une barrière physique entre l'environnement interne (en contact avec le fluide) et l'environnement externe,
- Ils ont un ressort métallique à l'intérieur qui applique une pression sur toute la circonférence de la lèvre inférieure du joint, améliorant ainsi son étanchéité.

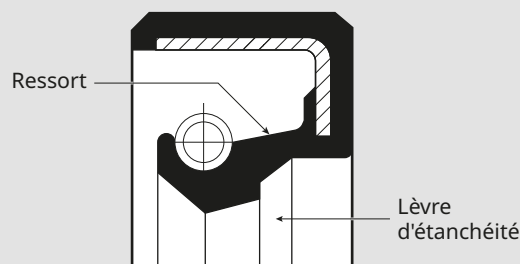

Notice d'installation

- Vérifier les informations du joint (taille et sens de rotation) et le type de matériau du joint d'étanchéité à remplacer,
- Retirer toute saleté et débris de toutes les surfaces métalliques qui entre en contact avec le joint d'étanchéité,
- **Ne pas appliquer de graisse ou de lubrifiant sur la surface extérieure du joint ou du boîtier de joint.** Si ces surfaces sont contaminées, l'étanchéité externe sera compromise dès l'installation du joint,
- **Appliquer de la graisse sur la lèvre d'étanchéité inférieure du joint et sur la surface glissante de l'arbre uniquement,**
- Mettre le joint en place avec les outils adaptés. Le côté montrant les informations du joint doit être tourné vers l'extérieur.



Le joint d'étanchéité est efficace presque immédiatement et le moteur peut être démarré après dix minutes.

Joint d'étanchéité PTFE (polytétrafluoréthylène)

Caractéristiques

Malgré l'absence de ressort métallique interne, ces joints d'étanchéité présentent les caractéristiques suivantes :

- Surface d'étanchéité en contact avec le métal plus large, offrant une étanchéité accrue,
- Amélioration de la résistance mécanique face aux contraintes, même à des vitesses de rotation élevées,
- Amélioration de la résistance chimique aux lubrifiants avec additifs,
- Meilleure résistance aux températures élevées,
- Réduction significative des fuites dues au frottement.

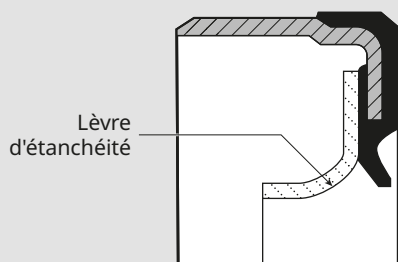

Notice d'installation



Ces joints d'étanchéité sont installés différemment des joints d'étanchéité de type « traditionnel » en FPM. La lèvre intérieure est protégée par une douille en plastique qui maintient la forme du joint et assure une parfaite adhérence à l'arbre. **La douille ne doit être retirée qu'au moment de l'installation du joint d'étanchéité.**

- Des outils spécifiques sont nécessaires pour installer le joint d'étanchéité. **Il ne faut en aucun cas endommager la lèvre intérieure du joint,**
- Le joint d'étanchéité en PTFE doit être installé à sec, sans utilisation de graisse et/ou de lubrifiant. **Ce type de joint d'étanchéité ne doit jamais être lubrifié,**
- Vérifier les informations du joint (taille et sens de rotation) et le type de matériau du joint d'étanchéité à remplacer,
- Retirer toute saleté et débris de toutes les surfaces métalliques qui entre en contact avec le joint d'étanchéité,
- Vérifier la surface de l'arbre en vous assurant qu'il est exempt de rainures ou d'autres dommages. Toute irrégularité doit être supprimée,
- Placer l'extrémité rainurée de la douille sur l'arbre. Insérer le joint d'étanchéité dans son logement en le faisant glisser le long de la douille. Une fois le joint d'étanchéité positionné dans son logement, retirer la douille.



Le joint d'étanchéité PTFE n'est pas efficace immédiatement. Il est nécessaire d'attendre jusqu'à 4 heures après le montage, avant de démarrer le moteur pour permettre au joint de s'adapter à l'arbre et d'obtenir une étanchéité totale.

Les instructions, les recommandations et les informations contenues dans cette publication ont été préparées avec la plus grande attention. Magneti Marelli Aftermarket Italy S.p.A., au nom et pour le compte de ses filiales, n'assume aucune responsabilité pour tout type de dommage, même dérivant d'une mauvaise interprétation des informations qui y sont contenues.

**MAGNETI
MARELLI**

PARTS & SERVICES

MCK0580

PROCEDIMIENTO DE REGULACIÓN DE LA VÁLVULA

Marcas: **Audi, Volkswagen**Modelos: **Audi A3, Volkswagen EOS, Golf V, Golf Plus, Jetta III, Passat VI, Touran**Códigos de motor: **BAG, BLF, BLG, BLP, BMY**Potencia: **1.4 FSI, 1.4 TSI, 1.6 FSI (115, 140, 170 CV)**Año: **02/2003** →

Precauciones generales

- Desconecte siempre el cable de tierra de la batería.
- Quitar las bujías para permitir que el motor gire con mayor libertad.
- Gire siempre el motor en el sentido normal de rotación (a menos que se indique específicamente lo contrario).
- **NO use** el equipo especial mencionado anteriormente para bloquear el motor cuando el piñón o los pernos de la polea estén aflojados.
- Respete los pares de apriete.
- Si está instalado: tenga en cuenta la posición del sensor de posición del eje del motor antes de desmontarlo.
- **NO gire** el eje del motor girando el árbol de levas u otros piñones.
- **NO gire** el eje del motor o el árbol de levas sin la cadena de distribución.

Procedimiento de sincronización de válvulas

- Para desmontar/montar la cadena de distribución es necesario:
 - Retirar la tapa de distribución.
 - Retirar el tapón.

! Marque el sentido de rotación en las cadenas.

- Colocar el manómetro y su soporte en el agujero de la bujía del cilindro n. 1. Asegúrese de que el motor esté en el PMS del cilindro n. 1 **1**.

- Asegúrese de que las marcas de distribución del árbol de levas estén alineadas como se muestra **2**.

De lo contrario, gire el eje del motor 360°.

- Montar la herramienta de alineación del árbol de levas **3**.

! Si no se puede insertar la herramienta de alineación del árbol de levas, la sincronización de la válvula no es correcta.

- Presione el tensor de la cadena y bloquéelo con el pasador de bloqueo **4**.

- Desmontar el piñón del árbol de levas y la cadena.

- Alinear los árboles de levas. Utilice la herramienta especial **3**.
- Montar el piñón del árbol de levas y la cadena de distribución.

• Motores con sincronización variable de válvulas:

Coloque un tornillo nuevo. Apriete el tornillo del dispositivo de ajuste del árbol de levas de admisión **5**. Par de apriete: 40 Nm + 90°.

! El tornillo del piñón del árbol de levas de admisión tiene rosca inversa.

• Motores sin sincronización variable de válvulas:

Apriete el tornillo del piñón del árbol de levas de admisión **6**. Par de apriete: 50 Nm + 90°.

- Apretar el tornillo del piñón del árbol de levas de escape. Par de apriete: 50 Nm + 90°.

- Apretar el tornillo de la polea del eje del motor. Par de apriete **7**:

- A = 150 Nm + 180°

- B = 90 Nm + 90°.

! El tornillo de la polea del eje del motor y todos los tornillos del piñón del árbol de levas **DEBEN** usarse una sola vez.

- Desmontar la herramienta de alineación del árbol de levas. Gire el eje del motor en el sentido de las agujas del reloj durante dos vueltas.

- Compruebe la sincronización de la válvula **3**.

Equipamiento especial

- Indicador de pantalla - n. VAS 6079.
- Soporte de indicador de pantalla - n. T10170.
- Herramienta de alineación del árbol de levas - n. T10171.
- Herramienta de bloqueo del piñón del árbol de levas - bomba de aceite - n. T10172.
- Herramienta de bloqueo del eje del motor - n. T10340.
- Herramienta de bloqueo de la polea del eje del motor - n. 3415.
- Pasador de bloqueo del tensor de cadena - n. T40011.

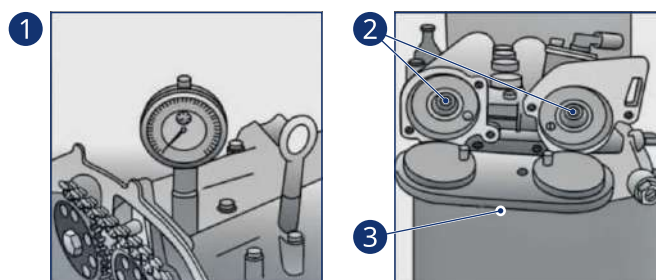

(40 Nm + 90°) (50 Nm + 90°)

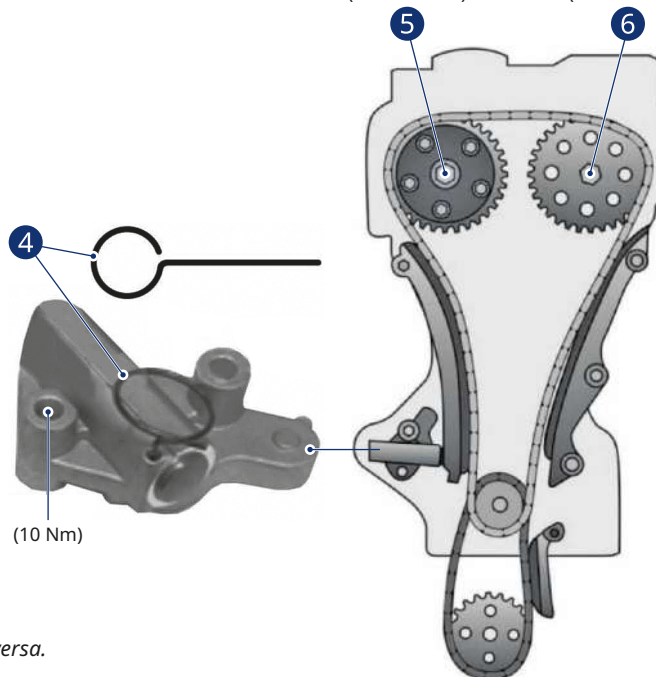

(10 Nm)

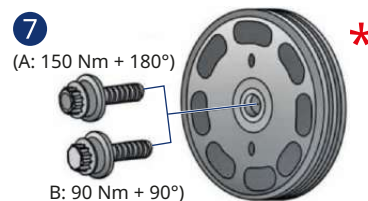

! El tensor de cadena contenido en este kit está cargado por resorte y puede causar daños si no se maneja correctamente. **NO** retire el pasador hasta que esté completamente instalado, y siempre asegúrese de que el pistón apunte lejos de usted o de cualquier otra persona dentro de un rango de 20 metros.

Las instrucciones, recomendaciones e información contenidos en esta publicación han sido preparadas con la mayor atención. Marelli Aftermarket Italy S.p.A., en su propio nombre y en el de sus filiales / subsidiarias, no asume responsabilidad por ningún tipo de daño, incluso derivado de una interpretación incorrecta de la información aquí contenida.

**MAGNETI
MARELLI**

PARTS & SERVICES

* ACLARACIÓN SOBRE EL PAR DE APRIETE DE TORNILLOS

En el boletín técnico se muestra la siguiente información:

- Apriete el tornillo de la polea del eje del motor.
Par de apriete ⑦:

- A = 150 Nm + 180°
- B = 90 Nm + 90°.

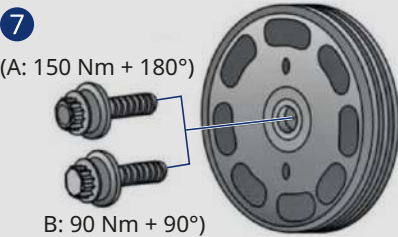

Dos pares de apriete para un solo tornillo. ¿Cuál?

A

Si en el vehículo se instala un **tornillo dodecaedro combinado**, con cabeza perforada, resistencia/categoría 10.9, dimensiones M14x1,5x100, OE n.º: N91048601 como el que se muestra a continuación:



El par de apriete máximo debe fijarse en: **150 Nm + 180°** (Caso A)

B

Si en el vehículo se instala un tornillo diferente "**sin cabeza de tornillo**", el par de apriete máximo debe fijarse en **90 Nm + 90°** (Caso B)



				PARTS	OE			
							COMPLETE KIT	EASY KIT
AUDI								
A1 (8X1, 8XK) 1.4 TFSI (05/10 → 04/15) CAXA; CNVA 90 kW								
				03C 105 209 AQ	Z = 18/18		MCK1210	MCK1240
				03C 115 225 A	54 Links/Bakla			
				03C 109 507 AD				
A1 (8X1, 8XK) 1.4 TFSI (01/11 → 04/15) CAVG; CTHG; CTJA 136 kW								
				03C 105 209 AG	Z = 23/18		MCK1200	MCK1240
				03C 115 225	56 Links/Bakla			
				03C 109 507 AF				
A1 Sportback (8XA, 8XF) 1.4 TFSI (11/11 → 04/15) CAXA; CNVA 90 kW								
				03C 105 209 AQ	Z = 18/18		MCK1210	MCK1240
				03C 115 225 A	54 Links/Bakla			
				03C 109 507 AD				
A1 Sportback (8XA, 8XF) 1.4 TFSI (11/11 → 04/15) CAVG; CTHG; CTJA 136 kW								
				03C 105 209 AG	Z = 23/18		MCK1200	MCK1240
				03C 115 225	56 Links/Bakla			
				03C 109 507 AF				
A3 (8P1) 1.6 FSI (08/03 → 09/07) BAG; BLF; BLP 85 kW								
				03C 105 209 AC / BE	Z = 18/18		MCK0580	MCK1240
				03C 115 230 C	54 Links/Bakla			
				03C 109 507 AE / J				
A3 Sportback (8PA) 1.6 FSI (09/04 → 09/07) BLF; BLP 85 kW								
				03C 105 209 AC / BE	Z = 18/18		MCK0580	MCK1240
				03C 115 230 C	54 Links/Bakla			
				03C 109 507 AE / J				
A3 (8P1) 1.4 TFSI (09/07 → 08/12) CAXC; CMSA 92 kW								
2007 → 2008				03C 105 209 AK	Z = 23/18; → 30/10/2007		MCK1200	MCK1240
				03C 115 225	56 Links/Bakla; → 30/10/2007			
				03C 109 507 AF				
2007 → 2008				03C 105 209 AC / BE	Z = 18/18; 30/10/2007 →		MCK0580	MCK1240
				03C 115 230 C	54 Links/Bakla; 30/10/2007 →			
				03C 109 507 AE / J				
2007 → 2008				03C 105 209 AM / BE	Z = 18/18		MCK0580	MCK1240
				03C 115 230 C	54 Links/Bakla; → 30/10/2007			
				03C 109 507 AE / J				
2008 → 2012				03C 105 209 AC / BE	Z = 18/18; → 21/07/2008		MCK0580	MCK1240
				03C 115 230 C	54 Links/Bakla; → 21/07/2008			
				03C 109 507 AE / J				
				03C 105 209 AQ	Z = 18/18; 21/07/2008 →			
				03C 115 225 A	54 Links/Bakla; 21/07/2008 →			
				03C 109 507 AD		MCK1210	MCK1240	



		PARTS	OE		MAGNETI MARELLI PARTS & SERVICES	
					COMPLETE KIT	EASY KIT
AUDI						
A3 Sportback (8PA) 1.4 TFSI (09/07 → 03/13) CAXC; CMSA 92 kW						
2007 → 2008	M		03C 105 209 AK	Z = 23/18; → 30/10/2007	MCK1200	MCK1240
			03C 115 225	56 Links/Bakla; → 30/10/2007		
			03C 109 507 AF			
	M		03C 105 209 AC / BE	Z = 18/18; 30/10/2007 →	MCK0580	MCK1240
			03C 115 230 C	54 Links/Bakla; 30/10/2007 →		
	A		03C 105 209 AM / BE	Z = 18/18	MCK0580	MCK1240
		03C 115 230 C	54 Links/Bakla; → 30/10/2007			
2009 → 2013			03C 105 209 AC / BE	Z = 18/18; → 21/07/2008	MCK0580	MCK1240
			03C 115 230 C	54 Links/Bakla; → 21/07/2008		
			03C 109 507 AE / J			
			03C 105 209 AQ	Z = 18/18; 21/07/2008 →	MCK1210	MCK1240
			03C 115 225 A	54 Links/Bakla; 21/07/2008 →		
			03C 109 507 AD			
A3 Cabriolet (8P7) 1.4 TFSI (02/11 → 05/13) CAXC 92 kW						
			03C 105 209 AQ / AR	Z = 18/18	MCK1210	MCK1240
			03C 115 225 A	54 Links/Bakla		
			03C 109 507 AD			
SEAT						
ALHAMBRA (710, 711) 1.4 TSI (06/10 →) CAVA; CNWB; CTHA 110 kW						
2011 → 2015			03C 105 209 AR	Z = 18/18	MCK1210	MCK1240
			03C 115 225 A	54 Links/Bakla		
			03C 109 507 AD			
ALTEA (5P1) 1.4 TSI (11/07 →) CAXC 92 kW						
2007 → 2010			03C 105 209 AC / BE	Z = 18/18; → 1P-9-023 795	MCK0580	MCK1240
			03C 115 230 C	54 Links/Bakla; → 5P-9-011 823		
			03C 109 507 AE / J			
			03C 105 209 AQ	Z = 18/18; 1P-9-023 795 →	MCK1210	MCK1240
			03C 115 225 A	54 Links/Bakla; 5P-9-011 823 →		
			03C 109 507 AD			
2011 → 2015			03C 105 209 AQ	Z = 18/18	MCK1210	MCK1240
			03C 115 225 A	54 Links/Bakla		
			03C 109 507 AD			
ALTEA XL (5P5, 5P8) 1.4 TSI (11/07 →) CAXC 92 kW						
2007 → 2010			03C 105 209 AC / BE	Z = 18/18; → 1P-9-023 795	MCK0580	MCK1240
			03C 115 230 C	54 Links/Bakla; → 5P-9-011 823		
			03C 109 507 AE / J			
			03C 105 209 AQ	Z = 18/18; 1P-9-023 795 →	MCK1210	MCK1240
			03C 115 225 A	54 Links/Bakla; 5P-9-011 823 →		
			03C 109 507 AD			
2011 → 2015			03C 105 209 AQ	Z = 18/18	MCK1210	MCK1240
			03C 115 225 A	54 Links/Bakla		
			03C 109 507 AD			
CORDOBA (6L2) 1.6 16V (11/06 → 11/09) BTS 77 kW						
			03C 105 209 AC / BE	Z = 18/18	MCK0580	MCK1240
			03C 115 230 C	54 Links/Bakla		
			03C 109 507 AE / J			



				PARTS	OE			COMPLETE KIT	EASY KIT
SEAT									
IBIZA III (6L1) 1.6 16V (11/06 → 11/09) BTS 77 kW									
				03C 105 209 AC / BE	Z = 18/18			MCK0580	MCK1240
				03C 115 230 C	54 Links/Bakla				
				03C 109 507 AE / J					
IBIZA IV (6J5, 6P1) 1.6 (05/08 → 03/12) BTS 77 kW									
				03C 105 209 AC / BE	Z = 18/18			MCK0580	MCK1240
				03C 115 230 C	54 Links/Bakla				
				03C 109 507 AE / J					
IBIZA IV SPORTCOUPE (6J1, 6P5) 1.6 (07/08 → 05/15) BTS 77 kW									
				03C 105 209 AC / BE	Z = 18/18			MCK0580	MCK1240
				03C 115 230 C	54 Links/Bakla				
				03C 109 507 AE / J					
IBIZA IV (6J5, 6P1), IBIZA IV SPORTCOUPE (6J1, 6P5) 1.4 TSI (01/09 → 05/15) CAVF; CNUB; CTHF; CTJB 110 kW									
				03C 105 209 AG	Z = 23/18			MCK1200	MCK1240
				03C 115 225	56 Links/Bakla				
				03C 109 507 AF					
IBIZA IV SPORTCOUPE (6J1, 6P5) 1.4 TSI Cupra (06/09 → 05/15) CAVE; CTHE; CTJC 132 kW									
				03C 105 209 AG	Z = 23/18			MCK1200	MCK1240
				03C 115 225	56 Links/Bakla				
				03C 109 507 AF					
IBIZA IV (6J5, 6P1); IBIZA IV SPORTCOUPE (6J1, 6P5) 1.6 LPG (05/11 → 05/15) CNKA 60 kW									
				03C 105 209 AC / BE	Z = 18/18			MCK0580	MCK1240
				03C 115 230 C	54 Links/Bakla				
				03C 109 507 AE / J					
IBIZA IV ST (6J8, 6P8) 1.4 TSI (02/12 → 05/15) CAVF; CNUB; CTHF; CTJB 110 kW									
				03C 105 209 AG	Z = 23/18			MCK1200	MCK1240
				03C 115 225	56 Links/Bakla				
				03C 109 507 AF					
LEON (1P1) 1.4 TSI (11/07 → 12/12) CAXC 92 kW									
2007 → 2010				03C 105 209 AC / BE	Z = 18/18; → 1P-9-023 795			MCK0580	MCK1240
				03C 115 230 C	54 Links/Bakla; → 1P-9-023 795				
				03C 109 507 AE / J					
				03C 105 209 AQ	Z = 18/18; 1P-9-023 796 →			MCK1210	MCK1240
				03C 115 225 A	54 Links/Bakla; 1P-9-023 796 →				
				03C 109 507 AD					
2011 → 2012				03C 105 209 AQ	Z = 18/18			MCK1210	MCK1240
				03C 115 225 A	54 Links/Bakla				
				03C 109 507 AD					
TOLEDO IV (KG3) 1.4 TSI (07/12 → 06/15) CAXA 90 kW									
				03C 105 209 AQ	Z = 18/18			MCK1210	MCK1240
				03C 115 225 A	54 Links/Bakla				
				03C 109 507 AD					
TOLEDO IV (KG3) 1.6 (07/13 → 06/15) CFNA 77 kW									
				03C 105 209 AC / BE	Z = 18/18			MCK0580	MCK1240
				03C 115 230 C	54 Links/Bakla				
				03C 109 507 AE / J					



		PARTS	OE			COMPLETE KIT	EASY KIT
SKODA							
FABIA II (542); FABIA II Combi (545) 1.6 (04/07 → 12/14) BTS; CFNA 77 kW							
			03C 105 209 AC / BE	Z = 18/18			
			03C 115 230 C	54 Links/Bakla	MCK0580	MCK1240	
			03C 109 507 AE / J				
FABIA II (542); FABIA II Combi (545) 1.4 TSI RS (05/10 → 12/14) CAVE; CTHE 132 kW							
			03C 105 209 AG	Z = 23/18			
			03C 115 225	56 Links/Bakla	MCK1200	MCK1240	
			03C 109 507 AF				
OCTAVIA II (1Z3); OCTAVIA II Combi (1Z5) 1.6 FSI (02/04 → 10/08) BLF 85 kW							
			03C 105 209 AC / BE	Z = 18/18			
			03C 115 230 C	54 Links/Bakla	MCK0580	MCK1240	
			03C 109 507 AE / J				
OCTAVIA II (1Z3); OCTAVIA II Combi (1Z5) 1.4 TSI (11/08 → 06/13) CAXA 90 kW							
			03C 105 209 AQ	Z = 18/18; → 11/05/2015			
			03C 115 225 A	54 Links/Bakla	MCK1210	MCK1240	
			03C 109 507 AD				
			03C 105 209 BD	Z = 19/18; 11/05/2015 →			
			03C 115 225 A	54 Links/Bakla	MCK1220	MCK1250	
			03C 109 507 AD				
RAPID (NH3); RAPID Spaceback (NH1) 1.4 TSI (07/12 → 06/15) CAXA 90 kW							
			03C 105 209 AQ	Z = 18/18; → 11/05/2015			
			03C 115 225 A	54 Links/Bakla	MCK1210	MCK1240	
			03C 109 507 AD				
			03C 105 209 BD	Z = 19/18; 11/05/2015 →			
			03C 115 225 A	54 Links/Bakla	MCK1220	MCK1250	
			03C 109 507 AD				
RAPID (NH3); RAPID Spaceback (NH1) 1.6 (07/12 → 06/15) CFNA 77 kW							
			03C 105 209 AC / BE	Z = 18/18			
			03C 115 230 C	54 Links/Bakla	MCK0580	MCK1240	
			03C 109 507 AE / J				
ROOMSTER (5J7) 1.6 (09/06 → 05/15) BTS; CFNA 77 kW							
			03C 105 209 AC / BE	Z = 18/18			
			03C 115 230 C	54 Links/Bakla	MCK0580	MCK1240	
			03C 109 507 AE / J				
ROOMSTER (5J7) 1.6 LPG (06/06 → 07/10) BTS 77 kW							
			03C 105 209 AC / BE	Z = 18/18			
			03C 115 230 C	54 Links/Bakla	MCK0580	MCK1240	
			03C 109 507 AE / J				
SUPERB II (3T4); SUPERB II Station wagon (3T5) 1.4 TSI (07/08 → 05/15) CAXC 92 kW							
2008 → 2013			03C 105 209 AQ	Z = 18/18; → 11/05/2015			
			03C 115 225 A	54 Links/Bakla; 01/08/2008 →	MCK1210	MCK1240	
			03C 109 507 AD				
			03C 105 209 BD	Z = 19/18; 11/05/2015 →			
			03C 115 225 A	54 Links/Bakla	MCK1220	MCK1250	
			03C 109 507 AD				



		PARTS		OE				MAGNETI MARELLI PARTS & SERVICES	
								COMPLETE KIT	EASY KIT
SKODA									
YETI (5L) 1.4 TSI (06/10 → 05/15) CAXA 90 kW									
			03C 105 209 AQ	Z = 18/18; → 11/05/2015	MCK1210	MCK1240			
			03C 115 225 A	54 Links/Bakla					
			03C 109 507 AD						
			03C 105 209 BD	Z = 19/18; 11/05/2015 →	MCK1220	MCK1250			
			03C 115 225 A	54 Links/Bakla					
			03C 109 507 AD						
VOLKSWAGEN									
BEETLE (5C1, 5C2; BEETLE Cabriolet (5C7, 5C8) 1.4 TSI (10/11 → 07/16) CAVD; CNWA; CTHD; CTKA 118 kW									
			03C 105 209 AR / AQ	Z = 18/18; → 11/05/2015	MCK1210	MCK1240			
			03C 115 225 A	54 Links/Bakla					
			03C 109 507 AD						
			03C 105 209 BD	Z = 19/18; 11/05/2015 →	MCK1220	MCK1250			
			03C 115 225 A	54 Links/Bakla					
			03C 109 507 AD						
CC (358) 1.4 TSI (11/11 → 12/16) CTHD 118 kW									
2012 → 2015			03C 105 209 AR / AQ	Z = 18/18; → 24/05/2015	MCK1210	MCK1240			
			03C 115 225 A	54 Links/Bakla					
			03C 109 507 AD						
			03C 105 209 BD	Z = 19/18; 25/05/2015 →	MCK1220	MCK1250			
			03C 115 225 A	54 Links/Bakla					
			03C 109 507 AD						
CC (358) 1.4 TSI MultiFuel (11/11 → 12/16) CKMA 118 kW									
2012 → 2015			03C 105 209 AR / AQ	Z = 18/18; → 24/05/2015	MCK1210	MCK1240			
			03C 115 225	54 Links/Bakla					
			03C 109 507 AD						
			03C 105 209 BD	Z = 19/18; 25/05/2015 →	MCK1220	MCK1250			
			03C 115 225A	54 Links/Bakla					
			03C 109 507 AD						
EOS (1F7, 1F8) 1.6 FSI (06/06 → 05/08) BLF 85 kW									
			03C 105 209 AC / BE	Z = 18/18	MCK0580	MCK1240			
			03C 115 230 C	54 Links/Bakla					
			03C 109 507 AE / J						
EOS (1F7, 1F8) 1.4 TSI (11/07 → 08/15) CAXA 90 kW									
2007 → 2008			03C 105 209 AC / BE	Z = 18/18	MCK0580	MCK1240			
			03C 115 230 C	54 Links/Bakla					
			03C 109 507 AE / J						
2009 → 2011			03C 105 209 AC	Z = 18/18; → 31/07/2008	MCK0580	MCK1240			
			03C 115 230 C	54 Links/Bakla; → 31/07/2008					
			03C 109 507 AE / J						
			03C 105 209 AQ	Z = 18/18; 01/08/2008 →	MCK1210	MCK1240			
			03C 115 225 A	54 Links/Bakla; 01/08/2008 →					
			03C 109 507 AD						
2012 → 2015			03C 105 209 AR / AQ	Z = 18/18; → 24/05/2015	MCK1210	MCK1240			
			03C 115 225 A	54 Links/Bakla					
			03C 109 507 AD						
			03C 105 209 BD	Z = 19/18; 25/05/2015 →	MCK1220	MCK1250			
			03C 115 225 A	54 Links/Bakla					
			03C 109 507 AD						



**MAGNETI
MARELLI**

PARTS & SERVICES

				PARTS	OE				
							COMPLETE KIT	EASY KIT	
VOLKSWAGEN									
EOS (1F7, 1F8) 1.4 TSI → 05/2015 (05/08 → 08/15) CAVD; CTHD 118 kW									
2009 → 2011				03C 105 209 AG	Z = 23/18; → 30/06/2008		MCK1200	MCK1240	
				03C 115 225	56 Links/Bakla; → 30/06/2008				
				03C 109 507 AF					
				03C 105 209 AR / AQ	Z = 18/18; 01/07/2008 →				
				03C 115 225 A	54 Links/Bakla; 01/07/2008 →				
				03C 109 507 AD					
2011 → 2015				03C 105 209 AR / AQ	Z = 18/18; → 24/05/2015		MCK0580	MCK1240	
				03C 115 225 A	54 Links/Bakla				
				03C 109 507 AD					
				03C 105 209 BD	Z = 19/18; 25/05/2015 →				
				03C 115 225 A	54 Links/Bakla				
				03C 109 507 AD					
GOLF PLUS (5M1, 521) 1.6 FSI (12/04 → 05/08) BLF 85 kW									
				03C 105 209 AC / BE	Z = 18/18		MCK0580	MCK1240	
				03C 115 230 C	54 Links/Bakla				
				03C 109 507 AE / J					
GOLF PLUS (5M1, 521) 1.4 FSI (07/05 → 11/06) BLN 66 kW									
				03C 105 209 AC / BE	Z = 18/18		MCK0580	MCK1240	
				03C 115 230 C	54 Links/Bakla				
				03C 109 507 AE / J					
GOLF PLUS (5M1, 521) 1.4 TSI (05/06 → 06/08) BMY; BLG 103; 125 kW									
				03C 105 209 AG	Z = 23/18		MCK1200	MCK1240	
				03C 115 225	56 Links/Bakla				
				03C 109 507 AF					
GOLF PLUS (5M1, 521) 1.4 TSI (06/07 → 12/13) CAXA 90 kW									
2008 → 2009				03C 105 209 AK / AG	Z = 23/18; → 1K-8-546 000		MCK1200	MCK1240	
				03C 115 225	56 Links/Bakla; → 1K-8-546 000				
				03C 109 507 AF					
				03C 105 209 AC / BE	Z = 18/18; 1K-8-546 001 → 1K-9-825 000		MCK0580	MCK1240	
				03C 115 230 C	54 Links/Bakla; 1K-8-546 001 → 1K-9-825 000				
				03C 109 507 AE / J					
				03C 105 209 AQ	Z = 18/18; 1K-9-825 001 →		MCK1210	MCK1240	
				03C 115 225 A	54 Links/Bakla; 1K-9-825 001 →				
				03C 109 507 AD					
				03C 105 209 AC / BE	Z = 18/18; → 1K-9-825 000		MCK0580	MCK1240	
				03C 115 230 C	→ 1K-9-825 000				
				03C 109 507 AE / J					
				03C 105 209 AQ	Z = 18/18; 1K-9-825 001 →		MCK1210	MCK1240	
				03C 115 225 A	1K-9-825 001 →				
				03C 109 507 AD					
	2009 → 2013				03C 105 209 AQ	Z = 18/18		MCK1210	MCK1240
					03C 115 225 A	54 Links/Bakla			
					03C 109 507 AD				
	GOLF PLUS (5M1, 521) 1.4 TSI (06/08 → 12/13) CAVD; CNWA; CTHD 118 kW								
					03C 105 209 AR / AQ	Z = 18/18		MCK1210	MCK1240
					03C 115 225 A	54 Links/Bakla			
					03C 109 507 AD				



**MAGNETI
MARELLI**

PARTS & SERVICES

		PARTS	OE		 COMPLETE KIT EASY KIT		
VOLKSWAGEN							
GOLF V (1K1) 1.4 FSI (10/03 → 07/06) BKG; BLN 66 kW							
			03C 105 209 AC / BE	Z = 18/18	MCK0580	MCK1240	
			03C 115 230 C	54 Links/Bakla			
			03C 109 507 AE / J				
GOLF V (1K1) 1.6 FSI (10/03 → 07/08) BAG; BLF; BLP 85 kW							
			03C 105 209 AC / BE	Z = 18/18	MCK0580	MCK1240	
			03C 115 230 C	54 Links/Bakla			
			03C 109 507 AE / J				
GOLF V (1K1) 1.4 TSI (05/07 → 11/08) CAXA 90 kW							
			03C 105 209 AK / AG	Z = 23/18; → 1K-8P050 000, → 1K-8U010 000, → 1K-8W150 000	MCK1200	MCK1240	
			03C 115 225	56 Links/Bakla			
			03C 109 507 AF				
				03C 105 209 AC / BE	Z = 18/18; 1K-8P050 001 →, → 1K-9P025 000, 1K-8U010 001 →, → 1K-9U008 000, 1K-8W150 001 →, → 1K-9W090 000	MCK0580	MCK1240
				03C 115 230 C	54 Links/Bakla		
				03C 109 507 AE / J			
				03C 105 209 AQ	Z = 18/18; 1K-9P025 001 →, 1K-9U008 001 →, 1K-9W090 001 →	MCK1210	MCK1240
				03C 115 225 A	54 Links/Bakla		
				03C 109 507 AD			
				03C 105 209 AC / BE	Z = 18/18; → 1K-9P025 000, → 1K-9U008 000, → 1K-9W090 000	MCK0580	MCK1240
				03C 115 230 C	54 Links/Bakla		
				03C 109 507 AE / J			
				03C 105 209 AQ	Z = 18/18; 1K-9P025 001 →, 1K-9U008 001 →, 1K-9W090 001 →	MCK1210	MCK1240
				03C 115 225 A	54 Links/Bakla		
				03C 109 507 AD			
	GOLF V Variant (1K5) 1.4 TSI (06/07 → 07/09) CAXA 90 kW						
				03C 105 209 AK / AG	Z = 23/18; → 31/10/2007	MCK1200	MCK1240
				03C 115 225	56 Links/Bakla		
			03C 109 507 AF				
				03C 105 209 AC / BE	Z = 18/18; 01/11/2007 → 31/07/2008	MCK0580	MCK1240
				03C 115 230 C	54 Links/Bakla		
				03C 109 507 AE / J			
				03C 105 209 AQ	Z = 18/18; 01/08/2008 → 31/06/2009	MCK1210	MCK1240
				03C 115 225 A	54 Links/Bakla		
				03C 109 507 AD			



**MAGNETI
MARELLI**

PARTS & SERVICES

		PARTS		OE				MAGNETI MARELLI PARTS & SERVICES	
								COMPLETE KIT	EASY KIT
VOLKSWAGEN									
GOLF VI (5K1) 1.4 TSI (10/08 → 11/12) CAXA 90 kW									
2008 → 2009			03C 105 209 AK / AG	Z = 23/18; → 1K-8P050 000, → 1K-8U010 000, → 1K-8W150 000	MCK1200	MCK1240		03C 115 225	56 Links/Bakla
			03C 109 507 AF						
			03C 105 209 AC / BE	Z = 18/18; 1K-8P050 001 →, → 1K-9P025 000, 1K-8U010 001 →, → 1K-9U008 000, 1K-8W150 001 →, → 1K-9W090 000					
			03C 105 209 AC / BE	Z = 18/18; 1K-8P050 001 →, → 1K-9P025 000, 1K-8U010 001 →, → 1K-9U008 000, 1K-8W150 001 →, → 1K-9W090 000	MCK0580	MCK1240		03C 115 230 C	54 Links/Bakla
			03C 109 507 AE / J						
			03C 105 209 AQ	Z = 18/18; 1K-9P025 001 →, 1K-9U008 001 →, 1K-9W090 001 →					
			03C 105 209 AQ	Z = 18/18; 1K-9P025 001 →, 1K-9U008 001 →, 1K-9W090 001 →	MCK1210	MCK1240		03C 115 225 A	54 Links/Bakla
			03C 109 507 AD						
			03C 105 209 AC / BE	Z = 18/18; 1K-9P025 000, → 1K-9U008 000, → 1K-9W090 000					
			03C 105 209 AC / BE	Z = 18/18; 1K-9P025 000, → 1K-9U008 000, → 1K-9W090 000	MCK0580	MCK1240		03C 115 230 C	54 Links/Bakla
			03C 109 507 AE / J						
			03C 105 209 AQ	Z = 18/18; 1K-9P025 001 →, 1K-9U008 001 →, 1K-9W090 001 →					
		03C 105 209 AQ	Z = 18/18; 1K-9P025 001 →, 1K-9U008 001 →, 1K-9W090 001 →	MCK1210	MCK1240		03C 115 225 A	54 Links/Bakla	
		03C 109 507 AD							
		03C 105 209 AQ	Z = 18/18						
2009 → 2012		03C 105 209 AQ	Z = 18/18	MCK1210	MCK1240		03C 115 225 A	54 Links/Bakla	
		03C 109 507 AD							
		03C 105 209 AQ / AR	Z = 18/18						
GOLF VI (5K1) 1.4 TSI (10/08 → 11/12) CAVD; CNWA; CTHD 118 kW									
		03C 105 209 AQ / AR	Z = 18/18	MCK1210	MCK1240		03C 115 225 A	54 Links/Bakla	
		03C 109 507 AD							
		03C 105 209 AQ / AR	Z = 18/18; → 24/05/2015						
		03C 115 225 A	54 Links/Bakla	MCK1210	MCK1240		03C 105 209 BD	Z = 19/18; 25/05/2015 →	
		03C 109 507 AD							
		03C 105 209 BD	Z = 19/18; 25/05/2015 →	MCK1220	MCK1250		03C 115 225 A	54 Links/Bakla	
		03C 109 507 AD							
GOLF VI Cabriolet (517) 1.4 TSI (03/11 → 05/16) CAVD; CNWA; CTHD; CTKA 118 kW									
		03C 105 209 AR / AQ	Z = 18/18; → 24/05/2015	MCK1210	MCK1240		03C 115 225 A	54 Links/Bakla	
		03C 109 507 AD							
		03C 105 209 BD	Z = 19/18; 25/05/2015 →						
		03C 115 225 A	54 Links/Bakla	MCK1220	MCK1250		03C 105 209 BD	Z = 19/18; 25/05/2015 →	
		03C 109 507 AD							
		03C 105 209 BD	Z = 19/18; 25/05/2015 →	MCK1220	MCK1250		03C 115 225 A	54 Links/Bakla	
		03C 109 507 AD							
GOLF VI Cabriolet (517) 1.4 TSI (11/11 → 05/16) CAXA 90 kW									
		03C 105 209 AR / AQ	Z = 18/18; → 24/05/2015	MCK1210	MCK1240		03C 115 225 A	54 Links/Bakla	
		03C 109 507 AD							
		03C 105 209 BD	Z = 19/18; 25/05/2015 →						
		03C 115 225 A	54 Links/Bakla	MCK1220	MCK1250		03C 105 209 BD	Z = 19/18; 25/05/2015 →	
		03C 109 507 AD							
		03C 105 209 BD	Z = 19/18; 25/05/2015 →	MCK1220	MCK1250		03C 115 225 A	54 Links/Bakla	
		03C 109 507 AD							
JETTA III (1K2) 1.6 FSI (09/05 → 10/10) BLF 85 kW									
		03C 105 209 AC / BE	Z = 18/18	MCK0580	MCK1240		03C 115 230 C	54 Links/Bakla	
		03C 109 507 AE / J							
		03C 105 209 AC / BE	Z = 18/18						
		03C 115 230 C	54 Links/Bakla	MCK0580	MCK1240		03C 105 209 AG	Z = 23/18	
		03C 109 507 AE / J							
		03C 105 209 AG	Z = 23/18	MCK1200	MCK1240		03C 115 225	56 Links/Bakla	
		03C 109 507 AF							
JETTA III (1K2) 1.4 TSI (07/06 → 10/10) BMY; BLG 103; 125 kW									
		03C 105 209 AG	Z = 23/18	MCK1200	MCK1240		03C 115 225	56 Links/Bakla	
		03C 109 507 AF							
		03C 105 209 AG	Z = 23/18						



		PARTS	OE		MAGNETI MARELLI PARTS & SERVICES	
					COMPLETE KIT	EASY KIT
VOLKSWAGEN						
JETTA III (1K2) 1.4 TSI (05/07 → 10/10) CAXA 90 kW						
2007 → 2008			03C 105 209 AK / AG	Z = 23/18	MCK1200	MCK1240
			03C 115 225	56 Links/Bakla		
			03C 109 507 AF			
			03C 105 209 AC / BE	Z = 18/18	MCK0580	MCK1240
			03C 115 230 C	54 Links/Bakla		
			03C 109 507 AE / J			
2009 → 2010			03C 105 209 AC	Z = 18/18; → 31/07/2008	MCK0580	MCK1240
			03C 115 230 C	54 Links/Bakla		
			03C 109 507 AE / J			
			03C 105 209 AQ	Z = 18/18; 01/08/2008 →		
			03C 115 225 A	54 Links/Bakla		
			03C 109 507 AD		MCK1210	MCK1240
JETTA IV (162, 163, AV3, AV2) 1.4 TSI (05/11 →) CAXA; CMSB; CAVA; CTHA; CAVD; CTHD 90; 110; 118 kW						
2011 → 2014			03C 105 209 AQ / AR	Z = 18/18	MCK1210	MCK1240
			03C 115 225 A	54 Links/Bakla		
			03C 109 507 AD			
2015 → 2018			03C 105 209 AR / AQ	Z = 18/18; → 11/05/2015	MCK1210	MCK1240
			03C 115 225 A	54 Links/Bakla		
			03C 109 507 AD			
			03C 105 209 BD	Z = 19/18; 12/05/2015 →		
			03C 115 225 A	54 Links/Bakla		
			03C 109 507 AD		MCK1220	MCK1250
JETTA IV (162, 163, AV3, AV2) 1.6 (12/11 →) CFNA; CLRA 77 kW						
			03C 105 209 AC / BE	Z = 18/18	MCK0580	MCK1240
			03C 115 230 C	54 Links/Bakla		
			03C 109 507 AE / J			
PASSAT (3C2) 1.6 FSI (03/05 → 06/08) BLF 85 kW						
			03C 105 209 AC / BE	Z 18/18	MCK0580	MCK1240
			03C 115 230 C	54 Links/Bakla		
			03C 109 507 J / AE			
PASSAT (3C2) 1.4 TSI (05/07 → 07/10) CAXA 90 kW						
2007 → 2008			03C 105 209 AK	Z = 23/18; → 3C-8E110 000, → 3C-8P060 000	MCK1200	MCK1240
			03C 115 225	56 Links/Bakla		
			03C 109 507 AB/ AF			
			03C 105 209 AC / BE	Z = 18/18; 3C-8E110 001 →, 3C-8P060 001 →		
			03C 115 230 C	54 Links/Bakla		
			03C 109 507 AE		MCK0580	MCK1240
2009 → 2010			03C 105 209 AC / BE	Z = 18/18; → 31/07/2008	MCK0580	MCK1240
			03C 115 230 C	54 Links/Bakla		
			03C 109 507 AE			
			03C 105 209 AQ	Z = 18/18; 01/08/2008 →		
			03C 115 225 A	54 Links/Bakla		
			03C 109 507 AD		MCK1210	MCK1240
PASSAT (3C2) 1.4 TSI EcoFuel (01/09 → 07/10) CDGA 110 kW						
			03C 105 209 AG	Z = 23/18	MCK1200	MCK1240
			03C 115 225	56 Links/Bakla		
			03C 109 507 AF			



				PARTS	OE			
							COMPLETE KIT	EASY KIT
VOLKSWAGEN								
*	PASSAT (362) 1.4 TSI	(08/10 → 12/14)		CAXA	90 kW			
	2010 → 2011			03C 105 209 AC / BE	Z = 18/18; → 31/07/2008		MCK0580	MCK1240
				03C 115 230 C	54 Links/Bakla			
				03C 109 507 AE / J				
				03C 105 209 AQ	Z = 18/18; 01/08/2008 →		MCK1210	MCK1240
				03C 115 225 A	54 Links/Bakla			
				03C 109 507 AD				
	2012 → 2014			03C 105 209 AQ	Z = 18/18		MCK1210	MCK1240
				03C 115 225 A	54 Links/Bakla			
				03C 109 507 AD				
*	PASSAT (362) 1.4 TSI EcoFuel	(08/10 → 12/14)		CDGA	110 kW			
				03C 105 209 AG	Z = 23/18		MCK1200	MCK1240
				03C 115 225	56 Links/Bakla			
				03C 109 507 AF				
*	PASSAT (362) 1.4 TSI MultiFuel	(11/10 → 12/14)		CKMA	118 kW			
				03C 105 209 AG	Z = 23/18		MCK1200	MCK1240
				03C 115 225	56 Links/Bakla			
				03C 109 507 AF				
*	PASSAT (362) 1.4 TSI	(11/12 → 12/14)		CTHD	118 kW			
				03C 105 209 AG	Z = 23/18		MCK1200	MCK1240
				03C 115 225	56 Links/Bakla			
				03C 109 507 AF				
	PASSAT CC (357) 1.4 TSI MultiFuel	(01/11 → 01/12)		CKMA	118 kW			
				03C 105 209 AG	Z = 23/18		MCK1200	MCK1240
				03C 115 225	56 Links/Bakla			
				03C 109 507 AF				
	PASSAT Variant (3C5) 1.6 FSI	(08/05 → 06/08)		BLF	85 kW			
				03C 105 209 AC / BE	Z = 18/18		MCK0580	MCK1240
				03C 115 230 C	54 Links/Bakla			
				03C 109 507 J / AE				
	PASSAT Variant (3C5) 1.4 TSI	(05/07 → 11/10)		CAXA	90 kW			
	2007 → 2008			03C 105 209 AK	Z = 23/18; → 3C-8E110 000, → 3C-8P060 000		MCK1200	MCK1240
				03C 115 225	56 Links/Bakla			
				03C 109 507 AB/ AF				
				03C 105 209 AC / BE	Z = 18/18; 3C-8E110 001 →, 3C-8P060 001 →		MCK0580	MCK1240
				03C 115 230 C	54 Links/Bakla			
				03C 109 507 AE				
	2009 → 2010			03C 105 209 AC / BE	Z = 18/18; → 31/07/2008		MCK0580	MCK1240
				03C 115 230 C	54 Links/Bakla			
				03C 109 507 AE				
				03C 105 209 AQ	Z = 18/18; 01/08/2008 →		MCK1210	MCK1240
				03C 115 225 A	54 Links/Bakla			
				03C 109 507 AD				
	PASSAT Variant (3C5) 1.4 TSI EcoFuel	(01/09 → 11/10)		CDGA	110 kW			
				03C 105 209 AG	Z = 23/18		MCK1200	MCK1240
				03C 115 225	56 Links/Bakla			
				03C 109 507 AF				



**MAGNETI
MARELLI**

PARTS & SERVICES

				PARTS	OE			
							COMPLETE KIT	EASY KIT
VOLKSWAGEN								
* PASSAT Variant (365) 1.4 TSI (08/10 → 12/14) CAXA 90 kW								
2010 → 2011				03C 105 209 AC / BE	Z = 18/18; → 31/07/2008		MCK0580	MCK1240
				03C 115 230 C	54 Links/Bakla			
				03C 109 507 AE				
				03C 105 209 AQ	Z = 18/18; 01/08/2008 →			
				03C 115 225 A	54 Links/Bakla			
2011 → 2014				03C 109 507 AD			MCK120	MCK1240
				03C 105 209 AQ	Z = 18/18; 01/08/2008 →			
				03C 115 225 A	54 Links/Bakla			
* PASSAT Variant (365) 1.4 TSI EcoFuel (08/10 → 12/14) CDGA 110 kW								
				03C 105 209 AG	Z = 23/18		MCK1200	MCK1240
				03C 115 225	56 Links/Bakla			
				03C 109 507 AF				
* PASSAT Variant (365) 1.4 TSI MultiFuel (11/10 → 12/14) CKMA 118 kW								
				03C 105 209 AG	Z = 23/18		MCK1200	MCK1240
				03C 115 225	56 Links/Bakla			
				03C 109 507 AF				
* PASSAT Variant (365) 1.4 TSI (11/12 → 12/14) CTHD 118 kW								
				03C 105 209 AG	Z = 23/18		MCK1200	MCK1240
				03C 115 225	56 Links/Bakla			
				03C 109 507 AF				
POLO (9N_) 1.4 FSI (02/02 → 07/06) AXU 63 kW								
				03C 105 209 AC / BE	Z = 18/18		MCK0580	MCK1240
				03C 115 230 C	54 Links/Bakla			
				03C 109 507 AE				
POLO (9N_) 1.6 16V (05/06 → 11/09) BTS 77 kW								
				03C 105 209 AC / BE	Z = 18/18		MCK0580	MCK1240
				03C 115 230 C	54 Links/Bakla			
				03C 109 507 AE				
POLO (6R1, 6C1) 1.4 (6R1) (03/09 → 05/14) ; CLPA 63 kW								
				03C 105 209 AC / BE	Z = 18/18		MCK0580	MCK1240
				03C 115 230 C	54 Links/Bakla			
				03C 109 507 AE				
POLO (6R1, 6C1) 1.4 GTI (05/10 →) CAVE; CTHE 132 kW								
				03C 105 209 AG	Z = 23/18		MCK1200	MCK1240
				03C 115 225	56 Links/Bakla			
				03C 109 507 AF				
POLO (6R1, 6C1) 1.6 BiFuel (01/11 →) CNKA 60 kW								
				03C 105 209 AC / BE	Z = 18/18		MCK0580	MCK1240
				03C 115 230 C	54 Links/Bakla			
				03C 109 507 AE				



**MAGNETI
MARELLI**

PARTS & SERVICES

				PARTS	OE			
							COMPLETE KIT	EASY KIT
VOLKSWAGEN								
SCIROCCO (137, 138) 1.4 TSI (08/08 → 11/17) CAXA; CMSB 90 kW								
2008 → 2015		03C 105 209 AQ	Z = 18/18				MCK1210	MCK1240
		03C 115 225 A	54 Links/Bakla					
		03C 109 507 AD						
2015 → 2018		03C 105 209 AQ	Z = 18/18; → 24/05/2015				MCK1210	MCK1240
		03C 115 225 A	54 Links/Bakla					
		03C 109 507 AD						
		03C 105 209 BD	Z = 19/18; 25/05/2015 →				MCK1220	MCK1250
		03C 115 225 A	54 Links/Bakla					
		03C 109 507 AD						
SCIROCCO (137, 138) 1.4 TSI (05/08 → 11/17) CAVD; CNWA; CTHD; CTKA 118 kW								
2008 → 2014		03C 105 209 AG	Z = 23/18; → 30/06/2008				MCK1200	MCK1240
		03C 115 225	56 Links/Bakla					
		03C 109 507 AF						
		03C 105 209 AR / AQ	Z = 18/18; 01/07/2008 →					
		03C 115 225 A	54 Links/Bakla					
2015 → 2018		03C 105 209 AQ	Z = 18/18; → 24/05/2015				MCK1210	MCK1240
		03C 115 225 A	54 Links/Bakla					
		03C 109 507 AD						
		03C 105 209 BD	Z = 19/18; 25/05/2015 →				MCK1220	MCK1250
		03C 115 225 A	54 Links/Bakla					
		03C 109 507 AD						
SHARAN (7N1, 7N2) 1.4 TSI (05/10 →) CAVA; CNWB; CTHA 110 kW								
2010 → 2016		03C 105 209 AR	Z = 18/18; → 24/05/2015				MCK1210	MCK1240
		03C 115 225 A	54 Links/Bakla					
		03C 109 507 AD						
		03C 105 209 BD	Z = 19/18; 25/05/2015 →					
		03C 115 225 A	54 Links/Bakla					
		03C 109 507 AD						
TIGUAN (5N_) 1.4 TSI (08/10 → 07/18) CAXA 90 kW								
2010 → 2011		03C 105 209 AQ	Z = 18/18				MCK1210	MCK1240
		03C 115 225 A	54 Links/Bakla					
		03C 109 507 AD						
2010 → 2011		03C 105 209 AR / AQ	Z = 18/18; → 24/05/2015				MCK1210	MCK1240
		03C 115 225 A	54 Links/Bakla					
		03C 109 507 AD						
		03C 105 209 BD	Z = 19/18; 25/05/2015 →				MCK1220	MCK1250
		03C 115 225 A	54 Links/Bakla					
		03C 109 507 AD						



**MAGNETI
MARELLI**

PARTS & SERVICES

				PARTS	OE			
							COMPLETE KIT	EASY KIT
VOLKSWAGEN								
TIGUAN (5N_) 1.4 TSI 4motion (09/07 → 07/18) BWK; CAVA; CTHA 110 kW								
2008 → 2011	AWD/4WD		03C 105 209 AG	Z = 23/18; → 02/11/2008				
			03C 115 225	56 Links/Bakla	MCK1200	MCK1240		
			03C 109 507 AF					
			03C 105 209 AR	Z = 18/18; 03/11/2008 →				
			03C 115 225 A	54 Links/Bakla	MCK1210	MCK1240		
			03C 109 507 AD					
2012 → 2018			03C 105 209 AR / AQ	Z = 18/18; → 24/05/2015				
			03C 115 225 A	54 Links/Bakla	MCK1210	MCK1240		
			03C 109 507 AD					
			03C 105 209 BD	Z = 19/18; 25/05/2015 →				
			03C 115 225 A	54 Links/Bakla	MCK1220	MCK1250		
			03C 109 507 AD					
TIGUAN (5N_) 1.4 TSI (05/08 → 07/18) CAVA, CTHA 110 kW								
2008 → 2011	AWD/4WD		03C 105 209 AG	Z = 23/18; → 02/11/2008 (4 motion)				
			03C 115 225	56 Links/Bakla	MCK1200	MCK1240		
			03C 109 507 AF					
	FWD		03C 105 209 AR	Z = 18/18; → 02/11/2008 (FWD)				
			03C 115 225 A	54 Links/Bakla	MCK1210	MCK1240		
			03C 109 507 AD					
2012 → 2018			03C 105 209 AR / AQ	Z = 18/18; → 24/05/2015				
			03C 115 225 A	54 Links/Bakla	MCK1210	MCK1240		
			03C 109 507 AD					
			03C 105 209 BD	Z = 19/18; 25/05/2015 →				
			03C 115 225 A	54 Links/Bakla	MCK1220	MCK1250		
			03C 109 507 AD					
TIGUAN (5N_) 1.4 TSI; 1.4 TSI 4motion (05/11 → 07/18) CAVD; CTHD 118 kW								
			03C 105 209 AR / AQ	Z = 18/18; → 24/05/2015				
			03C 115 225 A	54 Links/Bakla	MCK1210	MCK1240		
			03C 109 507 AD					
			03C 105 209 BD	Z = 19/18; 25/05/2015 →				
			03C 115 225 A	54 Links/Bakla	MCK1220	MCK1250		
			03C 109 507 AD					
TOURAN (1T1, 1T2) 1.6 FSI (02/03 → 01/07) BAG; BLF; BLP 85 kW								
			03C 105 209 AC / BE	Z = 18/18				
			03C 115 230 C	56 Links/Bakla	MCK0580	MCK1240		
			03C 109 507 J / AE					
TOURAN (1T1, 1T2) 1.4 TSI (02/06 → 05/10) BMY; CAVC 103 kW								
2006 → 2008			03C 105 209 AF / AG	Z = 23/18				
			03C 115 225	56 Links/Bakla	MCK1200	MCK1240		
			03C 109 507 AF					
2009 → 2010			03C 105 209 AF / AG	Z = 23/18; → 1T-9-150 000				
			03C 115 225	56 Links/Bakla	MCK1200	MCK1240		
			03C 109 507 AF					
			03C 105 209 AR	Z = 18/18; 1T-9-150 001 →				
			03C 115 225 A	54 Links/Bakla	MCK1210	MCK1240		
			03C 109 507 AD					



		PARTS	OE		COMPLETE KIT	EASY KIT
VOLKSWAGEN						
TOURAN (1T1, 1T2) 1.4 FSI (11/06 → 05/10) BLG; CAVB 125 kW						
2006 → 2008			03C 105 209 AF / AG	Z = 23/18	MCK1200	MCK1240
			03C 115 225	56 Links/Bakla		
			03C 109 507 AF			
2009 → 2010			03C 105 209 AF / AG	Z = 23/18; → 1T-9-150 000	MCK1200	MCK1240
			03C 115 225	56 Links/Bakla		
			03C 109 507 AF			
			03C 105 209 AR	Z = 18/18; 1T-9-150 001 →	MCK1210	MCK1240
			03C 115 225 A	54 Links/Bakla		
			03C 109 507 AD			
TOURAN (1T1, 1T2) 1.4 TSI EcoFuel (05/09 → 05/10) CDGA 110 kW						
			03C 105 209 AG	Z = 23/18	MCK1200	MCK1240
			03C 115 225	56 Links/Bakla		
			03C 109 507 AF			
TOURAN (1T3) 1.4 TSI (05/10 → 05/15) CAVC; CTHC 103 kW						
2010			03C 105 209 AF / AG	Z = 23/18; → 1T-9-150 000	MCK1200	MCK1240
			03C 115 225	56 Links/Bakla		
			03C 109 507 AF			
			03C 105 209 AR	Z = 18/18; 1T-9-150 001 →	MCK1210	MCK1240
			03C 115 225 A	54 Links/Bakla		
			03C 109 507 AD			
2011 → 2015			03C 105 209 AR	Z = 18/18	MCK1210	MCK1240
			03C 115 225 A	54 Links/Bakla		
			3C 109 507 AD			
TOURAN (1T3) 1.4 TSI (05/10 → 05/15) CAVB; CTHB 125 kW						
2010			03C 105 209 AF / AG	Z = 23/18; → 1T-9-150 000	MCK1200	MCK1240
			03C 115 225	56 Links/Bakla		
			03C 109 507 AF			
			03C 105 209 AR	Z = 18/18; 1T-9-150 001 →	MCK1210	MCK1240
			03C 115 225 A	54 Links/Bakla		
			03C 109 507 AD			
2011 → 2015			03C 105 209 AR	Z = 18/18	MCK1210	MCK1240
			03C 115 225 A	54 Links/Bakla		
			3C 109 507 AD			
TOURAN (1T3) 1.4 TSI EcoFuel (05/10 → 05/15) CDGA 110 kW						
			03C 105 209 AG	Z = 23/18	MCK1200	MCK1240
			03C 115 225	56 Links/Bakla		
			03C 109 507 AF			



**MAGNETI
MARELLI**

PARTS & SERVICES

* Los vehículos **VOLKSWAGEN PASSAT (362) 1.4 TSI**, fabricados del 08/2010 al 12/2014 y **VOLKSWAGEN PASSAT Variant (365) 1.4 TSI**, fabricados desde 08/2010 hasta 12/2014, ensamblados entre el período de dos años 2010-2011 están entre el cambio de generación de la sexta (B6) a la séptima (B7).

Por esta razón, según los programas OE, la configuración piñón-cigüeñal instalada podría ser la de la generación anterior.

En estos vehículos, la elección del kit de cadena de distribución correcto está relacionada con la individualización del año y el mes de producción, lo cual no es una tarea fácil (puede diferir del año de registro escrito en el documento de registro del vehículo).

A continuación, una tabla de limitaciones adicionales a considerar:

08/2010 ile 12/2014 tarihleri arasında üretilen **VOLKSWAGEN PASSAT (362) 1.4 TSI** araçları ve 08/2010 ile 12/2014 tarihleri arasında üretilen ve iki yıllık dönem (2010-2011) içinde montajı yapılan **VOLKSWAGEN PASSAT Variant (365) 1.4 TSI** araçları altıncı nesilden (B6) yedinci nesle (B7) geçişi temsil etmektedir.

Bundan dolayı, OE programlarına göre, takılmış olan pinyon - krank mili konfigürasyonu bir önceki nesil olabilir.

Bu araçlarda, doğru triger zinciri kitinin seçilmesi, üretim yılı ve ayının doğru tespit edilmesiyle ilgilidir, ancak bu kolay değildir (bu tarih, araç tescil belgesinde yazılı tescil yılından farklı olabilir).

Aşağıda dikkate alınması gereken bir ek sınırlamalar tablosu verilmiştir:

		COMPONENTES PARÇALAR	OE		MAGNETI MARELLI PARTS & SERVICES	
					COMPLETE KIT	EASY KIT
→ 2009 (D>>-MJ 2009)		Piñón Pinyon dişlisi	03C 105 209 AC / BE	Z =18/18; → 31/07/2008	MCK0580	MCK1240
		Cigüeñal Krank mili	03C 105 101 BF/BM			
		Cojinete de empuje Baskı yatağı	06B 105 313 D			
		Piñón Pinyon dişlisi	03C 105 209 AQ	Z =18/18; 01/08/2008 →	MCK1210	MCK1240
		Cigüeñal Krank mili	03C 105 101 BF/BM			
		Cojinete de empuje Baskı yatağı	06B 105 313 D			
2010 (D-MJ 2010>>>) → 2012		Piñón Pinyon dişlisi	03C 105 209 AQ	Z = 18/18	MCK1210	MCK1240
		Cigüeñal Krank mili	03C 105 101 BF/BM			
		Cojinete de empuje Baskı yatağı	06B 105 313 D			
2012 →		Piñón Pinyon dişlisi	03C 105 209 AQ	Z = 18/18	MCK1210	MCK1240
		Cigüeñal Krank mili	03C 105 101 BM			
		Cojinete de empuje Baskı yatağı	06B 105 313 D			

Teniendo en cuenta todas estas diferentes variables, recomendamos verificar rigurosamente, a través de programas OE, los componentes instalados en el vehículo, para identificar el kit de reemplazo de la cadena de distribución correcto.

Tüm bu farklı değişkenleri göz önünde bulundurarak, doğru triger zinciri değiştirme kitini belirlemek için OE programları aracılığıyla araca takılı bileşenleri kontrol etmenizi tavsiye ederiz.



Años de producción del vehículo | Araç üretim yılları

**MAGNETI
MARELLI**

PARTS & SERVICES

FPM y PTFE junta de aceite

INSTRUCCIONES Y PRECAUCIONES PARA UNA CORRECTA INSTALACIÓN

Los juegos de cadenas de Magneti Marelli Parts & Services incluyen dos tipos de juntas de aceite, uno en **FPM** (caucho fluorado) y el otro en **PTFE** (Politetrafluoroetileno).

Las dos juntas de aceite se diferencian no solo por el material del que están hechos, sino también en términos del método de la instalación correcta y las precauciones relativas.

FPM (caucho fluorado) juntas de aceite

Características

- Estas juntas de aceite se consideran del tipo "tradicional".
- Crean una barrera física entre el ambiente interno, en contacto con el fluido, y el ambiente externo.
- Tienen un resorte metálico en el interior que aplica presión en toda la circunferencia del labio interior de la junta de aceite, mejorando así la estanqueidad.

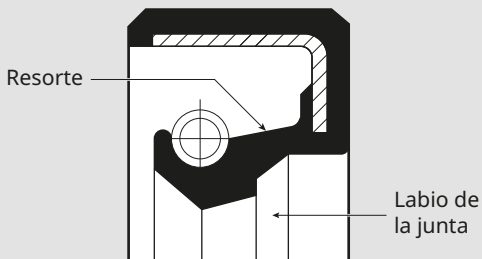

Instrucciones de instalación

- Verifique los datos de la junta (tamaño y sentido de giro) y el tipo de material del sello de aceite a reemplazar.
- Elimine la suciedad y los desechos de todas las superficies metálicas que entren en contacto con el sello de aceite.
- **No aplique grasa ni lubricantes a la superficie exterior del sello de aceite.** Si estas superficies están contaminadas, el sellado externo se verá comprometido tan pronto como sea colocado.
- **Aplique grasa en el labio de sellado interior de la junta de aceite y en la superficie de deslizamiento del eje únicamente.**
- Montar la junta en su sitio con las herramientas adecuadas. El lado que muestra los datos de la junta debe estar orientado hacia afuera.



La junta de aceite es efectiva casi de inmediato y el motor puede ser encendido después de diez minutos.

PTFE (politetrafluoroetileno) junta de aceite

Características

A pesar de la ausencia de un resorte metálico interno, estas juntas de aceite tienen las siguientes características:

- Mayor superficie de sellado en contacto con el metal, proporcionando mayor estanqueidad.
- Resistencia mecánica mejorada a la tensión incluso en altas velocidades de rotación.
- Resistencia química mejorada a lubricantes con aditivos.
- Resistencia mejorada a las altas temperaturas.
- Reducción significativa de fugas por fricción.

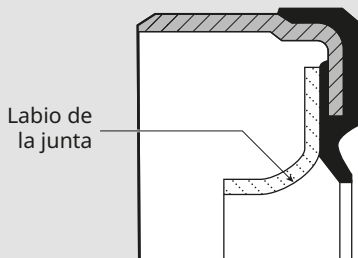

Instrucciones de instalación



Estas juntas de aceite se instalan de manera diferente a las "tradicionales" en FPM; el labio interior está protegido por un manguito de plástico que mantiene la forma de la junta y asegura una perfecta adherencia al eje. **El manguito solo se debe quitar al instalar la junta de aceite.**

- Se requieren herramientas específicas para instalar la junta de aceite. **No dañe el labio interior de la junta de ninguna manera.**
- La junta de aceite de PTFE debe instalarse en seco, sin el uso de grasa y/o lubricantes. **Esta junta nunca debe lubricarse.**
- Verifique los datos de la junta (tamaño y sentido de giro) y el tipo de material de la junta de aceite a reemplazar.
- Elimine la suciedad y los desechos de todas las superficies metálicas que entren en contacto con la junta de aceite.
- Verifique la superficie del eje, asegurándose de que esté libre de ranuras u otros daños. Deben eliminarse todas las irregularidades.
- Coloque el extremo ranurado del manguito en el eje. Inserte la junta de aceite en su alojamiento deslizando a lo largo del manguito. Una vez que la junta se haya colocado en su alojamiento, retire el manguito.



La junta de aceite de PTFE no es efectiva de inmediato. Deje transcurrir hasta cuatro horas después del montaje antes de arrancar el motor para permitir que la junta se adapte al eje y logre un ajuste total.

Las instrucciones, recomendaciones e información contenidos en esta publicación han sido preparadas con la mayor atención. Magneti Marelli Aftermarket Italy S.p.A., en su propio nombre y en el de sus filiales / subsidiarias, no asume responsabilidad por ningún tipo de daño, incluso derivado de una interpretación incorrecta de la información aquí contenida.

**MAGNETI
MARELLI**

PARTS & SERVICES

MCK0580

SUPAP ZAMANLAMASI PROSEDÜRÜ

Araç markaları: **Audi, Volkswagen**

Modeller: **Audi A3, Volkswagen EOS, Golf V, Golf Plus, Jetta III, Passat VI, Touran**

Motor kodu: **BAG, BLF, BLG, BLP, BMY**

Güç: **1.4 FSI, 1.4 TSI, 1.6 FSI (115, 140, 170 CV)**

Yıl: **02/2003** →

Genel önlemler

- Daima şasi kablosunu aküden ayırın.
- Motorun daha rahat dönmesi için bujileri sökün.
- Motoru her zaman normal dönme yönünde çevirin (aksi belirtilmedikçe).
- Sıkma torklarına dikkat edin.
- Takılırsa: sökmeden önce motor mili konum sensörünün konumunu not edin.
- Eksantrik milini veya diğer pinyon dişlileri çevirerek motor milini çevirmeye **ÇALIŞMAYIN**.
- Triger zinciri sökümü iken motor milini veya eksantrik milini **ÇEVİRMEYİN**.

Supap zamanlaması prosedürü

- Triger zincirini sökme/takmak için, şunları yapmak gerekir:
 - Triger zinciri muhafazası kapağını çıkarın.
 - Fincanı çıkarın.

! Zincirlerin dönme yönünü not edin.

- Ölçme aletini ve desteğini 1 No'lu silindirin buji deliğine yerleştirin. Motorun 1 No'lu silindirin üst ölü noktasında (ÜÖN) olduğundan emin olun **1**.

- Eksantrik mili üzerindeki zamanlama işaretlerinin gösterildiği gibi hizalandığından emin olun **2**. Aksi halde, motor milini 360° çevirin.

- Eksantrik mili hizalama aletini takın **3**.

! Eksantrik mili hizalama aleti takılamıyorsa, supap zamanlaması doğru değildir.

- Zincir gergisini bastırın ve kilitleme pimi ile bloke edin **4**.

- Eksantrik mili pinyon dişlisini ve zinciri sökün.

- Eksantrik millerini hizalayın. Özel aleti kullanın **3**.

- Eksantrik mili pinyon dişlisini ve triger zincirini takın.

Değişken supap zamanlamalı motorlar:

Yeni bir civata takın. Emme eksantrik mili ayar cihazı civatasını sıkın. Sıkma torku: 40 Nm + 90°.

! Emme eksantrik mili pinyon dişlisi civatası ters dişlidir.

Değişken supap zamanlamalı olmayan motorlar:

Emme eksantrik mili pinyon dişlisi civatasını sıkın **6**. Sıkma torku: 50 Nm + 90°.

- Egzoz eksantrik mili pinyon dişlisi civatasını sıkın. Sıkma torku: 50 Nm + 90°.

- Motor mili kasnağı civatasını sıkın. Sıkma torku **7**:

- A = 150 Nm + 180°
- B = 90 Nm + 90°.

! Motor mili kasnak civatası ve tüm eksantrik mili pinyon dişli civataları yalnızca bir kez **KULLANILMALIDIR**.

- Eksantrik mili hizalama aletini çıkarın. Motor milini saat yönünde iki tur döndürün.

- Subap zamanlamasını kontrol edin **3**.

Özel ekipman

- Ölçme aleti - No. VAS 6079.
- Ölçme aleti desteği - No. T10170.
- Eksantrik mili hizalama aleti - No. T10171.
- Eksantrik mili pinyon dişlisi - yağ pompası tutma aleti - No. T10172.
- Motor mili tutma aleti - No. T10340.
- Motor mili kasnağı tutma aleti - No. 3415.
- Zincir gergisi kilitleme pimi - No. T40011.

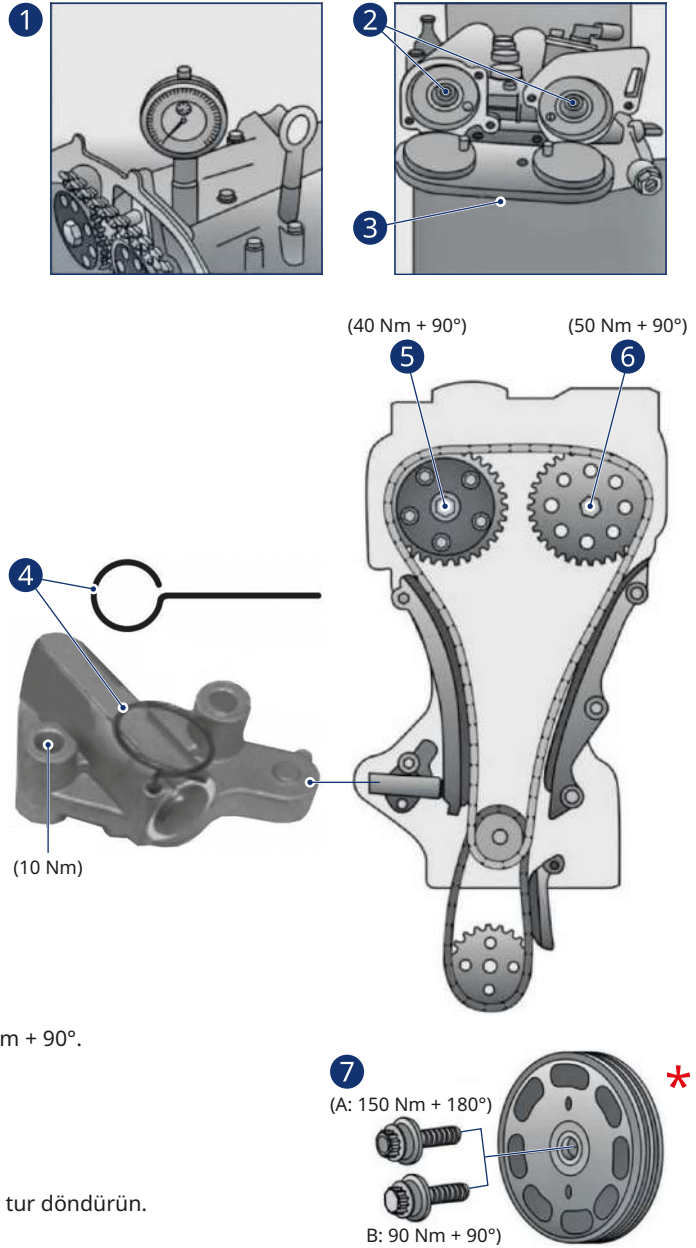

! Bu kittede bulunan zincir gergisi yaylıdır ve düzgün kullanılmazsa hasara yol açabilir. Tamamen oturmadan pimi **ÇIKARMAYIN** ve pistonun daima sizden veya 20 metrelik bir menzile içindeki diğer insanlardan uzağa doğru baktığından emin olun.

Bu yayında yer alan talimatlar, tavsiyeler ve bilgiler büyük bir titizlikle hazırlanmıştır.

Marelli Aftermarket Italy S.p.A., bağlı şirketleri/yan kuruluşları adına ve namına, burada yer alan bilgilerin yanlış yorumlanmasından kaynaklanan hasarlardan dolayı herhangi bir sorumluluk kabul etmez.

**MAGNETI
MARELLI**

PARTS & SERVICES

* VİDA SIKMA TORKU İLE İLGİLİ AÇIKLAMA

Teknik bültende aşağıdaki bilgiler verilmiştir:

- Motor mili kasnağı civatasını sıkın.
Sıkma torku **7**:
 - A = 150 Nm + 180°
 - B = 90 Nm + 90°.

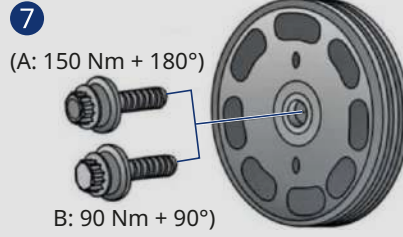

Tek bir vida için iki sıkma torku var. Hangisi?

A

Araca, aşağıda gösterildiği gibi, oyuk başlı, 10.9 dirençli/ kategorili, M14x1,5x100 boyutlu, N91048601 parça numaralı **kombine on iki köşeli bir vida** takılıysa:



Maksimum sıkma torku: **150 Nm + 180°** (Durum A).

B

Araca "**vida başı olmayan**" farklı bir vida takılmışsa, maksimum sıkma torku **90 Nm + 90°** olmalıdır (Durum B).

**MAGNETI
MARELLI**

PARTS & SERVICES

Motores VW FSI y TFSI

GUÍA DE IDENTIFICACIÓN DEL KIT DE REPARACIÓN CORRECTO

Los motores tipo FSI y TFSI del grupo VW se caracterizan por una alta complejidad y variabilidad de componentes que dificultan la identificación del kit de reparación de la cadena de distribución correcto. A continuación se muestra un esquema que, considerando los componentes instalados en el vehículo, ayuda a identificar el kit adecuado a utilizar.

VW FSI ve TFSI motorlar

DOĞRU TAMİR KİTİ BELİRLEME KILAVUZU

COMPLVW grubu FSI ve TFSI motor tipinin, doğru triger zinciri tamir kitinin belirlenmesini zorlaştıran çok karmaşıklık yapısı ve değişken bileşenleri vardır. Aşağıda, araca takılan bileşenler dikkate alınarak, kullanılacak doğru kitin belirlenmesine yardımcı olan bir şema verilmiştir.

LEYENDA | SEMBOL LEJANDI

PERIODO DE APLICABILIDAD UYGULANABİLİRLİK DÖNEMİ	TRANSMISIÓN ŞANZİMAN TİPİ	TRACCIÓN ÇEKİŞ TİPİ	DESCRIPCIÓN DEL PRODUCTO PARÇA AÇIKLAMASI	CÓDIGO OE OE REFERANSI	NOTAS NOTLAR	
Período de producción completo Tüm üretim dönemi	Cambio automático Otomatik şanziman	Cambio manual Düz şanziman	Caja de cambio DSG Direct-Shift (Çift Kavramalı) Vites Kutusu	4WD 4 ruedas 4-Teker Çekişli	AWD Todas las ruedas Tüm Tekerleklerden Çekişli	FWD Tracción delantera Önden Çekişli
			Piñón Zincir Dişlisi	Cadena Zincir	Tensor Gergi	
					Número de chasis Şasi numarası	Número motor Motor numarası
					→ XXX Hasta XXX XXX'den	XXX → De XXX XXX'e
					CÓDIGOS MAGNETI MARELLI MAGNETI MARELLI REFERANSLARI	

A1 (8X1, 8XK) 1.4 TFSI	(05/10→04/15)	CAXA; CNVA	90 kW										
Vehículo Araç	Año de producción Üretim yılı	Código de motor Motor kodu	Potencia motor Motor gücü										

Las instrucciones, recomendaciones e información contenidos en esta publicación han sido preparadas con la mayor atención. Marelli Aftermarket Italy S.p.A., en su propio nombre y en el de sus filiales / subsidiarias, no asume responsabilidad por ningún tipo de daño, incluso derivado de una interpretación incorrecta de la información aquí contenida.

Bu yayında yer alan talimatlar, tavsiyeler ve bilgiler büyük bir titizlikle hazırlanmıştır.

Marelli Aftermarket Italy S.p.A., bağlı şirketleri/yan kuruluşları adına ve namına, burada yer alan bilgilerin yanlış yorumlanmasından kaynaklanan hasarlardan dolayı herhangi bir sorumluluk kabul etmez.



				PARTS	OE			
							COMPLETE KIT	EASY KIT
AUDI								
A1 (8X1, 8XK) 1.4 TFSI (05/10 → 04/15) CAXA; CNVA 90 kW								
				03C 105 209 AQ	Z = 18/18		MCK1210	MCK1240
				03C 115 225 A	54 Links/Bakla			
				03C 109 507 AD				
A1 (8X1, 8XK) 1.4 TFSI (01/11 → 04/15) CAVG; CTHG; CTJA 136 kW								
				03C 105 209 AG	Z = 23/18		MCK1200	MCK1240
				03C 115 225	56 Links/Bakla			
				03C 109 507 AF				
A1 Sportback (8XA, 8XF) 1.4 TFSI (11/11 → 04/15) CAXA; CNVA 90 kW								
				03C 105 209 AQ	Z = 18/18		MCK1210	MCK1240
				03C 115 225 A	54 Links/Bakla			
				03C 109 507 AD				
A1 Sportback (8XA, 8XF) 1.4 TFSI (11/11 → 04/15) CAVG; CTHG; CTJA 136 kW								
				03C 105 209 AG	Z = 23/18		MCK1200	MCK1240
				03C 115 225	56 Links/Bakla			
				03C 109 507 AF				
A3 (8P1) 1.6 FSI (08/03 → 09/07) BAG; BLF; BLP 85 kW								
				03C 105 209 AC / BE	Z = 18/18		MCK0580	MCK1240
				03C 115 230 C	54 Links/Bakla			
				03C 109 507 AE / J				
A3 Sportback (8PA) 1.6 FSI (09/04 → 09/07) BLF; BLP 85 kW								
				03C 105 209 AC / BE	Z = 18/18		MCK0580	MCK1240
				03C 115 230 C	54 Links/Bakla			
				03C 109 507 AE / J				
A3 (8P1) 1.4 TFSI (09/07 → 08/12) CAXC; CMSA 92 kW								
2007 → 2008				03C 105 209 AK	Z = 23/18; → 30/10/2007		MCK1200	MCK1240
				03C 115 225	56 Links/Bakla; → 30/10/2007			
				03C 109 507 AF				
2007 → 2008				03C 105 209 AC / BE	Z = 18/18; 30/10/2007 →		MCK0580	MCK1240
				03C 115 230 C	54 Links/Bakla; 30/10/2007 →			
				03C 109 507 AE / J				
2007 → 2008				03C 105 209 AM / BE	Z = 18/18		MCK0580	MCK1240
				03C 115 230 C	54 Links/Bakla; → 30/10/2007			
				03C 109 507 AE / J				
2008 → 2012				03C 105 209 AC / BE	Z = 18/18; → 21/07/2008		MCK0580	MCK1240
				03C 115 230 C	54 Links/Bakla; → 21/07/2008			
				03C 109 507 AE / J				
				03C 105 209 AQ	Z = 18/18; 21/07/2008 →			
				03C 115 225 A	54 Links/Bakla; 21/07/2008 →			
				03C 109 507 AD		MCK1210	MCK1240	



		PARTS	OE		MAGNETI MARELLI PARTS & SERVICES	
					COMPLETE KIT	EASY KIT
AUDI						
A3 Sportback (8PA) 1.4 TFSI (09/07 → 03/13) CAXC; CMSA 92 kW						
2007 → 2008	M		03C 105 209 AK	Z = 23/18; → 30/10/2007	MCK1200	MCK1240
			03C 115 225	56 Links/Bakla; → 30/10/2007		
			03C 109 507 AF			
	M		03C 105 209 AC / BE	Z = 18/18; 30/10/2007 →	MCK0580	MCK1240
			03C 115 230 C	54 Links/Bakla; 30/10/2007 →		
	A		03C 105 209 AM / BE	Z = 18/18	MCK0580	MCK1240
		03C 115 230 C	54 Links/Bakla; → 30/10/2007			
2009 → 2013			03C 105 209 AC / BE	Z = 18/18; → 21/07/2008	MCK0580	MCK1240
			03C 115 230 C	54 Links/Bakla; → 21/07/2008		
			03C 109 507 AE / J			
			03C 105 209 AQ	Z = 18/18; 21/07/2008 →	MCK1210	MCK1240
			03C 115 225 A	54 Links/Bakla; 21/07/2008 →		
			03C 109 507 AD			
A3 Cabriolet (8P7) 1.4 TFSI (02/11 → 05/13) CAXC 92 kW						
			03C 105 209 AQ / AR	Z = 18/18	MCK1210	MCK1240
			03C 115 225 A	54 Links/Bakla		
			03C 109 507 AD			
SEAT						
ALHAMBRA (710, 711) 1.4 TSI (06/10 →) CAVA; CNWB; CTHA 110 kW						
2011 → 2015			03C 105 209 AR	Z = 18/18	MCK1210	MCK1240
			03C 115 225 A	54 Links/Bakla		
			03C 109 507 AD			
ALTEA (5P1) 1.4 TSI (11/07 →) CAXC 92 kW						
2007 → 2010			03C 105 209 AC / BE	Z = 18/18; → 1P-9-023 795	MCK0580	MCK1240
			03C 115 230 C	54 Links/Bakla; → 5P-9-011 823		
			03C 109 507 AE / J			
			03C 105 209 AQ	Z = 18/18; 1P-9-023 795 →	MCK1210	MCK1240
			03C 115 225 A	54 Links/Bakla; 5P-9-011 823 →		
			03C 109 507 AD			
2011 → 2015			03C 105 209 AQ	Z = 18/18	MCK1210	MCK1240
			03C 115 225 A	54 Links/Bakla		
			03C 109 507 AD			
ALTEA XL (5P5, 5P8) 1.4 TSI (11/07 →) CAXC 92 kW						
2007 → 2010			03C 105 209 AC / BE	Z = 18/18; → 1P-9-023 795	MCK0580	MCK1240
			03C 115 230 C	54 Links/Bakla; → 5P-9-011 823		
			03C 109 507 AE / J			
			03C 105 209 AQ	Z = 18/18; 1P-9-023 795 →	MCK1210	MCK1240
			03C 115 225 A	54 Links/Bakla; 5P-9-011 823 →		
			03C 109 507 AD			
2011 → 2015			03C 105 209 AQ	Z = 18/18	MCK1210	MCK1240
			03C 115 225 A	54 Links/Bakla		
			03C 109 507 AD			
CORDOBA (6L2) 1.6 16V (11/06 → 11/09) BTS 77 kW						
			03C 105 209 AC / BE	Z = 18/18	MCK0580	MCK1240
			03C 115 230 C	54 Links/Bakla		
			03C 109 507 AE / J			



		PARTS	OE	<i>i</i>	MAGNETI MARELLI PARTS & SERVICES COMPLETE KIT EASY KIT	
SEAT						
IBIZA III (6L1) 1.6 16V (11/06 → 11/09) BTS 77 kW						
			03C 105 209 AC / BE	Z = 18/18	MCK0580	MCK1240
			03C 115 230 C	54 Links/Bakla		
			03C 109 507 AE / J			
IBIZA IV (6J5, 6P1) 1.6 (05/08 → 03/12) BTS 77 kW						
			03C 105 209 AC / BE	Z = 18/18	MCK0580	MCK1240
			03C 115 230 C	54 Links/Bakla		
			03C 109 507 AE / J			
IBIZA IV SPORTCOUPE (6J1, 6P5) 1.6 (07/08 → 05/15) BTS 77 kW						
			03C 105 209 AC / BE	Z = 18/18	MCK0580	MCK1240
			03C 115 230 C	54 Links/Bakla		
			03C 109 507 AE / J			
IBIZA IV (6J5, 6P1), IBIZA IV SPORTCOUPE (6J1, 6P5) 1.4 TSI (01/09 → 05/15) CAVF; CNUB; CTHF; CTJB 110 kW						
			03C 105 209 AG	Z = 23/18	MCK1200	MCK1240
			03C 115 225	56 Links/Bakla		
			03C 109 507 AF			
IBIZA IV SPORTCOUPE (6J1, 6P5) 1.4 TSI Cupra (06/09 → 05/15) CAVE; CTHE; CTJC 132 kW						
			03C 105 209 AG	Z = 23/18	MCK1200	MCK1240
			03C 115 225	56 Links/Bakla		
			03C 109 507 AF			
IBIZA IV (6J5, 6P1); IBIZA IV SPORTCOUPE (6J1, 6P5) 1.6 LPG (05/11 → 05/15) CNKA 60 kW						
			03C 105 209 AC / BE	Z = 18/18	MCK0580	MCK1240
			03C 115 230 C	54 Links/Bakla		
			03C 109 507 AE / J			
IBIZA IV ST (6J8, 6P8) 1.4 TSI (02/12 → 05/15) CAVF; CNUB; CTHF; CTJB 110 kW						
			03C 105 209 AG	Z = 23/18	MCK1200	MCK1240
			03C 115 225	56 Links/Bakla		
			03C 109 507 AF			
LEON (1P1) 1.4 TSI (11/07 → 12/12) CAXC 92 kW						
2007 → 2010			03C 105 209 AC / BE	Z = 18/18; → 1P-9-023 795	MCK0580	MCK1240
			03C 115 230 C	54 Links/Bakla; → 1P-9-023 795		
			03C 109 507 AE / J			
			03C 105 209 AQ	Z = 18/18; 1P-9-023 796 →	MCK1210	MCK1240
			03C 115 225 A	54 Links/Bakla; 1P-9-023 796 →		
			03C 109 507 AD			
2011 → 2012			03C 105 209 AQ	Z = 18/18	MCK1210	MCK1240
			03C 115 225 A	54 Links/Bakla		
			03C 109 507 AD			
TOLEDO IV (KG3) 1.4 TSI (07/12 → 06/15) CAXA 90 kW						
			03C 105 209 AQ	Z = 18/18	MCK1210	MCK1240
			03C 115 225 A	54 Links/Bakla		
			03C 109 507 AD			
TOLEDO IV (KG3) 1.6 (07/13 → 06/15) CFNA 77 kW						
			03C 105 209 AC / BE	Z = 18/18	MCK0580	MCK1240
			03C 115 230 C	54 Links/Bakla		
			03C 109 507 AE / J			



		PARTS	OE			COMPLETE KIT	EASY KIT
SKODA							
FABIA II (542); FABIA II Combi (545) 1.6 (04/07 → 12/14) BTS; CFNA 77 kW							
			03C 105 209 AC / BE	Z = 18/18			
			03C 115 230 C	54 Links/Bakla	MCK0580	MCK1240	
			03C 109 507 AE / J				
FABIA II (542); FABIA II Combi (545) 1.4 TSI RS (05/10 → 12/14) CAVE; CTHE 132 kW							
			03C 105 209 AG	Z = 23/18			
			03C 115 225	56 Links/Bakla	MCK1200	MCK1240	
			03C 109 507 AF				
OCTAVIA II (1Z3); OCTAVIA II Combi (1Z5) 1.6 FSI (02/04 → 10/08) BLF 85 kW							
			03C 105 209 AC / BE	Z = 18/18			
			03C 115 230 C	54 Links/Bakla	MCK0580	MCK1240	
			03C 109 507 AE / J				
OCTAVIA II (1Z3); OCTAVIA II Combi (1Z5) 1.4 TSI (11/08 → 06/13) CAXA 90 kW							
			03C 105 209 AQ	Z = 18/18; → 11/05/2015			
			03C 115 225 A	54 Links/Bakla	MCK1210	MCK1240	
			03C 109 507 AD				
			03C 105 209 BD	Z = 19/18; 11/05/2015 →			
			03C 115 225 A	54 Links/Bakla	MCK1220	MCK1250	
			03C 109 507 AD				
RAPID (NH3); RAPID Spaceback (NH1) 1.4 TSI (07/12 → 06/15) CAXA 90 kW							
			03C 105 209 AQ	Z = 18/18; → 11/05/2015			
			03C 115 225 A	54 Links/Bakla	MCK1210	MCK1240	
			03C 109 507 AD				
			03C 105 209 BD	Z = 19/18; 11/05/2015 →			
			03C 115 225 A	54 Links/Bakla	MCK1220	MCK1250	
			03C 109 507 AD				
RAPID (NH3); RAPID Spaceback (NH1) 1.6 (07/12 → 06/15) CFNA 77 kW							
			03C 105 209 AC / BE	Z = 18/18			
			03C 115 230 C	54 Links/Bakla	MCK0580	MCK1240	
			03C 109 507 AE / J				
ROOMSTER (5J7) 1.6 (09/06 → 05/15) BTS; CFNA 77 kW							
			03C 105 209 AC / BE	Z = 18/18			
			03C 115 230 C	54 Links/Bakla	MCK0580	MCK1240	
			03C 109 507 AE / J				
ROOMSTER (5J7) 1.6 LPG (06/06 → 07/10) BTS 77 kW							
			03C 105 209 AC / BE	Z = 18/18			
			03C 115 230 C	54 Links/Bakla	MCK0580	MCK1240	
			03C 109 507 AE / J				
SUPERB II (3T4); SUPERB II Station wagon (3T5) 1.4 TSI (07/08 → 05/15) CAXC 92 kW							
2008 → 2013			03C 105 209 AQ	Z = 18/18; → 11/05/2015			
			03C 115 225 A	54 Links/Bakla; 01/08/2008 →	MCK1210	MCK1240	
			03C 109 507 AD				
			03C 105 209 BD	Z = 19/18; 11/05/2015 →			
			03C 115 225 A	54 Links/Bakla	MCK1220	MCK1250	
			03C 109 507 AD				



		PARTS		OE				MAGNETI MARELLI PARTS & SERVICES	
								COMPLETE KIT	EASY KIT
SKODA									
YETI (5L) 1.4 TSI (06/10 → 05/15) CAXA 90 kW									
			03C 105 209 AQ	Z = 18/18; → 11/05/2015	MCK1210	MCK1240			
			03C 115 225 A	54 Links/Bakla					
			03C 109 507 AD						
			03C 105 209 BD	Z = 19/18; 11/05/2015 →	MCK1220	MCK1250			
			03C 115 225 A	54 Links/Bakla					
			03C 109 507 AD						
VOLKSWAGEN									
BEETLE (5C1, 5C2; BEETLE Cabriolet (5C7, 5C8) 1.4 TSI (10/11 → 07/16) CAVD; CNWA; CTHD; CTKA 118 kW									
			03C 105 209 AR / AQ	Z = 18/18; → 11/05/2015	MCK1210	MCK1240			
			03C 115 225 A	54 Links/Bakla					
			03C 109 507 AD						
			03C 105 209 BD	Z = 19/18; 11/05/2015 →	MCK1220	MCK1250			
			03C 115 225 A	54 Links/Bakla					
			03C 109 507 AD						
CC (358) 1.4 TSI (11/11 → 12/16) CTHD 118 kW									
2012 → 2015			03C 105 209 AR / AQ	Z = 18/18; → 24/05/2015	MCK1210	MCK1240			
			03C 115 225 A	54 Links/Bakla					
			03C 109 507 AD						
			03C 105 209 BD	Z = 19/18; 25/05/2015 →	MCK1220	MCK1250			
			03C 115 225 A	54 Links/Bakla					
			03C 109 507 AD						
CC (358) 1.4 TSI MultiFuel (11/11 → 12/16) CKMA 118 kW									
2012 → 2015			03C 105 209 AR / AQ	Z = 18/18; → 24/05/2015	MCK1210	MCK1240			
			03C 115 225	54 Links/Bakla					
			03C 109 507 AD						
			03C 105 209 BD	Z = 19/18; 25/05/2015 →	MCK1220	MCK1250			
			03C 115 225A	54 Links/Bakla					
			03C 109 507 AD						
EOS (1F7, 1F8) 1.6 FSI (06/06 → 05/08) BLF 85 kW									
			03C 105 209 AC / BE	Z = 18/18	MCK0580	MCK1240			
			03C 115 230 C	54 Links/Bakla					
			03C 109 507 AE / J						
EOS (1F7, 1F8) 1.4 TSI (11/07 → 08/15) CAXA 90 kW									
2007 → 2008			03C 105 209 AC / BE	Z = 18/18	MCK0580	MCK1240			
			03C 115 230 C	54 Links/Bakla					
			03C 109 507 AE / J						
2009 → 2011			03C 105 209 AC	Z = 18/18; → 31/07/2008	MCK0580	MCK1240			
			03C 115 230 C	54 Links/Bakla; → 31/07/2008					
			03C 109 507 AE / J						
			03C 105 209 AQ	Z = 18/18; 01/08/2008 →	MCK1210	MCK1240			
			03C 115 225 A	54 Links/Bakla; 01/08/2008 →					
			03C 109 507 AD						
2012 → 2015			03C 105 209 AR / AQ	Z = 18/18; → 24/05/2015	MCK1210	MCK1240			
			03C 115 225 A	54 Links/Bakla					
			03C 109 507 AD						
			03C 105 209 BD	Z = 19/18; 25/05/2015 →	MCK1220	MCK1250			
			03C 115 225 A	54 Links/Bakla					
			03C 109 507 AD						



				PARTS	OE							
								COMPLETE KIT	EASY KIT			
VOLKSWAGEN												
EOS (1F7, 1F8) 1.4 TSI → 05/2015 (05/08 → 08/15) CAVD; CTHD 118 kW												
2009 → 2011				03C 105 209 AG	Z = 23/18; → 30/06/2008	MCK1200	MCK1240					
				03C 115 225	56 Links/Bakla; → 30/06/2008							
				03C 109 507 AF								
				03C 105 209 AR / AQ	Z = 18/18; 01/07/2008 →							
				03C 115 225 A	54 Links/Bakla; 01/07/2008 →							
2011 → 2015				03C 109 507 AD		MCK1210	MCK1240					
				03C 105 209 AR / AQ	Z = 18/18; → 24/05/2015							
				03C 115 225 A	54 Links/Bakla							
				03C 109 507 AD								
				03C 105 209 BD	Z = 19/18; 25/05/2015 →							
2011 → 2015				03C 115 225 A	54 Links/Bakla	MCK1210	MCK1240					
				03C 109 507 AD								
				03C 105 209 BD	Z = 19/18; 25/05/2015 →							
				03C 115 225 A	54 Links/Bakla							
				03C 109 507 AD								
GOLF PLUS (5M1, 521) 1.6 FSI (12/04 → 05/08) BLF 85 kW												
				03C 105 209 AC / BE	Z = 18/18	MCK0580	MCK1240					
				03C 115 230 C	54 Links/Bakla							
				03C 109 507 AE / J								
GOLF PLUS (5M1, 521) 1.4 FSI (07/05 → 11/06) BLN 66 kW												
				03C 105 209 AC / BE	Z = 18/18	MCK0580	MCK1240					
				03C 115 230 C	54 Links/Bakla							
				03C 109 507 AE / J								
GOLF PLUS (5M1, 521) 1.4 TSI (05/06 → 06/08) BMY; BLG 103; 125 kW												
				03C 105 209 AG	Z = 23/18	MCK1200	MCK1240					
				03C 115 225	56 Links/Bakla							
				03C 109 507 AF								
GOLF PLUS (5M1, 521) 1.4 TSI (06/07 → 12/13) CAXA 90 kW												
2008 → 2009				03C 105 209 AK / AG	Z = 23/18; → 1K-8-546 000	MCK1200	MCK1240					
				03C 115 225	56 Links/Bakla; → 1K-8-546 000							
				03C 109 507 AF								
				03C 105 209 AC / BE	Z = 18/18; 1K-8-546 001 → 1K-9-825 000	MCK0580	MCK1240					
				03C 115 230 C	54 Links/Bakla; 1K-8-546 001 → 1K-9-825 000							
				03C 109 507 AE / J								
				03C 105 209 AQ	Z = 18/18; 1K-9-825 001 →	MCK1210	MCK1240					
				03C 115 225 A	54 Links/Bakla; 1K-9-825 001 →							
				03C 109 507 AD								
				03C 105 209 AC / BE	Z = 18/18; → 1K-9-825 000	MCK0580	MCK1240					
				03C 115 230 C	→ 1K-9-825 000							
				03C 109 507 AE / J								
				03C 105 209 AQ	Z = 18/18; 1K-9-825 001 →	MCK1210	MCK1240					
				03C 115 225 A	1K-9-825 001 →							
				03C 109 507 AD								
	2009 → 2013				03C 105 209 AQ	Z = 18/18	MCK1210	MCK1240				
					03C 115 225 A	54 Links/Bakla						
					03C 109 507 AD							
	GOLF PLUS (5M1, 521) 1.4 TSI (06/08 → 12/13) CAVD; CNWA; CTHD 118 kW											
					03C 105 209 AR / AQ	Z = 18/18	MCK1210	MCK1240				
					03C 115 225 A	54 Links/Bakla						
					03C 109 507 AD							



		PARTS		OE				MAGNETI MARELLI PARTS & SERVICES	
								COMPLETE KIT	EASY KIT
VOLKSWAGEN									
GOLF V (1K1) 1.4 FSI (10/03 → 07/06) BKG; BLN 66 kW									
			03C 105 209 AC / BE	Z = 18/18	MCK0580	MCK1240			
			03C 115 230 C	54 Links/Bakla					
			03C 109 507 AE / J						
GOLF V (1K1) 1.6 FSI (10/03 → 07/08) BAG; BLF; BLP 85 kW									
			03C 105 209 AC / BE	Z = 18/18	MCK0580	MCK1240			
			03C 115 230 C	54 Links/Bakla					
			03C 109 507 AE / J						
GOLF V (1K1) 1.4 TSI (05/07 → 11/08) CAXA 90 kW									
			03C 105 209 AK / AG	Z = 23/18; → 1K-8P050 000, → 1K-8U010 000, → 1K-8W150 000	MCK1200	MCK1240			
			03C 115 225	56 Links/Bakla					
			03C 109 507 AF						
			03C 105 209 AC / BE	Z = 18/18; 1K-8P050 001 →, → 1K-9P025 000, 1K-8U010 001 →, → 1K-9U008 000, 1K-8W150 001 →, → 1K-9W090 000	MCK0580	MCK1240			
			03C 115 230 C	54 Links/Bakla					
			03C 109 507 AE / J						
			03C 105 209 AQ	Z = 18/18; 1K-9P025 001 →, 1K-9U008 001 →, 1K-9W090 001 →	MCK1210	MCK1240			
			03C 115 225 A	54 Links/Bakla					
			03C 109 507 AD						
			03C 105 209 AC / BE	Z = 18/18; → 1K-9P025 000, → 1K-9U008 000, → 1K-9W090 000	MCK0580	MCK1240			
			03C 115 230 C	54 Links/Bakla					
			03C 109 507 AE / J						
			03C 105 209 AQ	Z = 18/18; 1K-9P025 001 →, 1K-9U008 001 →, 1K-9W090 001 →	MCK1210	MCK1240			
			03C 115 225 A	54 Links/Bakla					
			03C 109 507 AD						
GOLF V Variant (1K5) 1.4 TSI (06/07 → 07/09) CAXA 90 kW									
			03C 105 209 AK / AG	Z = 23/18; → 31/10/2007	MCK1200	MCK1240			
			03C 115 225	56 Links/Bakla					
			03C 109 507 AF						
			03C 105 209 AC / BE	Z = 18/18; 01/11/2007 → 31/07/2008	MCK0580	MCK1240			
			03C 115 230 C	54 Links/Bakla					
			03C 109 507 AE / J						
			03C 105 209 AQ	Z = 18/18; 01/08/2008 → 31/06/2009	MCK1210	MCK1240			
			03C 115 225 A	54 Links/Bakla					
			03C 109 507 AD						



**MAGNETI
MARELLI**

PARTS & SERVICES

		PARTS	OE		MAGNETI MARELLI PARTS & SERVICES	
					COMPLETE KIT	EASY KIT
VOLKSWAGEN						
GOLF VI (5K1) 1.4 TSI (10/08 → 11/12) CAXA 90 kW						
2008 → 2009			03C 105 209 AK / AG	Z = 23/18; → 1K-8P050 000, → 1K-8U010 000, → 1K-8W150 000	MCK1200	MCK1240
			03C 115 225	56 Links/Bakla		
			03C 109 507 AF			
			03C 105 209 AC / BE	Z = 18/18; 1K-8P050 001 →, → 1K-9P025 000, 1K-8U010 001 →, → 1K-9U008 000, 1K-8W150 001 →, → 1K-9W090 000	MCK0580	MCK1240
			03C 115 230 C	54 Links/Bakla		
			03C 109 507 AE / J			
			03C 105 209 AQ	Z = 18/18; 1K-9P025 001 →, 1K-9U008 001 →, 1K-9W090 001 →	MCK1210	MCK1240
			03C 115 225 A	54 Links/Bakla		
			03C 109 507 AD			
			03C 105 209 AC / BE	Z = 18/18; → 1K-9P025 000, → 1K-9U008 000, → 1K-9W090 000	MCK0580	MCK1240
			03C 115 230 C	54 Links/Bakla		
			03C 109 507 AE / J			
			03C 105 209 AQ	Z = 18/18; 1K-9P025 001 →, 1K-9U008 001 →, 1K-9W090 001 →	MCK1210	MCK1240
			03C 115 225 A	54 Links/Bakla		
			03C 109 507 AD			
2009 → 2012		03C 105 209 AQ	Z = 18/18	MCK1210	MCK1240	
		03C 115 225 A	54 Links/Bakla			
		03C 109 507 AD				
GOLF VI (5K1) 1.4 TSI (10/08 → 11/12) CAVD; CNWA; CTHD 118 kW						
		03C 105 209 AQ / AR	Z = 18/18	MCK1210	MCK1240	
		03C 115 225 A	54 Links/Bakla			
		03C 109 507 AD				
GOLF VI Cabriolet (517) 1.4 TSI (03/11 → 05/16) CAVD; CNWA; CTHD; CTKA 118 kW						
		03C 105 209 AR / AQ	Z = 18/18; → 24/05/2015	MCK1210	MCK1240	
		03C 115 225 A	54 Links/Bakla			
		03C 109 507 AD				
		03C 105 209 BD	Z = 19/18; 25/05/2015 →	MCK1220	MCK1250	
		03C 115 225 A	54 Links/Bakla			
	03C 109 507 AD					
GOLF VI Cabriolet (517) 1.4 TSI (11/11 → 05/16) CAXA 90 kW						
		03C 105 209 AR / AQ	Z = 18/18; → 24/05/2015	MCK1210	MCK1240	
		03C 115 225 A	54 Links/Bakla			
		03C 109 507 AD				
		03C 105 209 BD	Z = 19/18; 25/05/2015 →	MCK1220	MCK1250	
		03C 115 225 A	54 Links/Bakla			
	03C 109 507 AD					
JETTA III (1K2) 1.6 FSI (09/05 → 10/10) BLF 85 kW						
		03C 105 209 AC / BE	Z = 18/18	MCK0580	MCK1240	
		03C 115 230 C	54 Links/Bakla			
		03C 109 507 AE / J				
JETTA III (1K2) 1.4 TSI (07/06 → 10/10) BMY; BLG 103; 125 kW						
		03C 105 209 AG	Z = 23/18	MCK1200	MCK1240	
		03C 115 225	56 Links/Bakla			
		03C 109 507 AF				



		PARTS	OE			COMPLETE KIT	EASY KIT
VOLKSWAGEN							
JETTA III (1K2) 1.4 TSI (05/07 → 10/10) CAXA 90 kW							
2007 → 2008			03C 105 209 AK / AG	Z = 23/18	MCK1200	MCK1240	
			03C 115 225	56 Links/Bakla			
			03C 109 507 AF				
2007 → 2008			03C 105 209 AC / BE	Z = 18/18	MCK0580	MCK1240	
			03C 115 230 C	54 Links/Bakla			
			03C 109 507 AE / J				
2009 → 2010			03C 105 209 AC	Z = 18/18; → 31/07/2008	MCK0580	MCK1240	
			03C 115 230 C	54 Links/Bakla			
			03C 109 507 AE / J				
			03C 105 209 AQ	Z = 18/18; 01/08/2008 →			
			03C 115 225 A	54 Links/Bakla			
2009 → 2010			03C 109 507 AD		MCK1210	MCK1240	
			03C 105 209 AQ / AR	Z = 18/18			
			03C 115 225 A	54 Links/Bakla			
			03C 109 507 AD				
			03C 105 209 AR / AQ	Z = 18/18; → 11/05/2015			
2015 → 2018			03C 115 225 A	54 Links/Bakla	MCK1210	MCK1240	
			03C 109 507 AD				
			03C 105 209 BD	Z = 19/18; 12/05/2015 →			
			03C 115 225 A	54 Links/Bakla			
			03C 109 507 AD				
JETTA IV (162, 163, AV3, AV2) 1.4 TSI (05/11 →) CAXA; CMSB; CAVA; CTHA; CAVD; CTHD 90; 110; 118 kW							
2011 → 2014			03C 105 209 AQ / AR	Z = 18/18	MCK1210	MCK1240	
			03C 115 225 A	54 Links/Bakla			
			03C 109 507 AD				
2015 → 2018			03C 105 209 AR / AQ	Z = 18/18; → 11/05/2015	MCK1210	MCK1240	
			03C 115 225 A	54 Links/Bakla			
			03C 109 507 AD				
			03C 105 209 BD	Z = 19/18; 12/05/2015 →			
			03C 115 225 A	54 Links/Bakla			
2015 → 2018			03C 109 507 AD		MCK1220	MCK1250	
			03C 105 209 AC / BE	Z = 18/18			
			03C 115 230 C	54 Links/Bakla			
			03C 109 507 AE / J				
			03C 105 209 AC / BE	Z = 18/18			
JETTA IV (162, 163, AV3, AV2) 1.6 (12/11 →) CFNA; CLRA 77 kW							
			03C 105 209 AC / BE	Z = 18/18	MCK0580	MCK1240	
			03C 115 230 C	54 Links/Bakla			
			03C 109 507 AE / J				
PASSAT (3C2) 1.6 FSI (03/05 → 06/08) BLF 85 kW							
			03C 105 209 AC / BE	Z 18/18	MCK0580	MCK1240	
			03C 115 230 C	54 Links/Bakla			
			03C 109 507 J / AE				
PASSAT (3C2) 1.4 TSI (05/07 → 07/10) CAXA 90 kW							
2007 → 2008			03C 105 209 AK	Z = 23/18; → 3C-8E110 000, → 3C-8P060 000	MCK1200	MCK1240	
			03C 115 225	56 Links/Bakla			
			03C 109 507 AB/ AF				
			03C 105 209 AC / BE	Z = 18/18; 3C-8E110 001 →, 3C-8P060 001 →			
			03C 115 230 C	54 Links/Bakla			
2009 → 2010			03C 109 507 AE		MCK0580	MCK1240	
			03C 105 209 AC / BE	Z = 18/18; → 31/07/2008			
			03C 115 230 C	54 Links/Bakla			
			03C 109 507 AE				
			03C 105 209 AQ	Z = 18/18; 01/08/2008 →			
2009 → 2010			03C 115 225 A	54 Links/Bakla	MCK1210	MCK1240	
			03C 109 507 AD				
			03C 105 209 AG	Z = 23/18			
PASSAT (3C2) 1.4 TSI EcoFuel (01/09 → 07/10) CDGA 110 kW							
			03C 115 225	56 Links/Bakla	MCK1200	MCK1240	
			03C 105 209 AG	Z = 23/18			
			03C 109 507 AF				



				PARTS	OE			
							COMPLETE KIT	EASY KIT
VOLKSWAGEN								
*	PASSAT (362) 1.4 TSI	(08/10 → 12/14)		CAXA	90 kW			
	2010 → 2011			03C 105 209 AC / BE	Z = 18/18; → 31/07/2008		MCK0580	MCK1240
				03C 115 230 C	54 Links/Bakla			
				03C 109 507 AE / J				
				03C 105 209 AQ	Z = 18/18; 01/08/2008 →			
				03C 115 225 A	54 Links/Bakla		MCK1210	MCK1240
				03C 109 507 AD				
	2012 → 2014			03C 105 209 AQ	Z = 18/18			
				03C 115 225 A	54 Links/Bakla		MCK1210	MCK1240
				03C 109 507 AD				
*	PASSAT (362) 1.4 TSI EcoFuel	(08/10 → 12/14)		CDGA	110 kW			
				03C 105 209 AG	Z = 23/18			
				03C 115 225	56 Links/Bakla		MCK1200	MCK1240
				03C 109 507 AF				
*	PASSAT (362) 1.4 TSI MultiFuel	(11/10 → 12/14)		CKMA	118 kW			
				03C 105 209 AG	Z = 23/18			
				03C 115 225	56 Links/Bakla		MCK1200	MCK1240
				03C 109 507 AF				
*	PASSAT (362) 1.4 TSI	(11/12 → 12/14)		CTHD	118 kW			
				03C 105 209 AG	Z = 23/18			
				03C 115 225	56 Links/Bakla		MCK1200	MCK1240
				03C 109 507 AF				
	PASSAT CC (357) 1.4 TSI MultiFuel	(01/11 → 01/12)		CKMA	118 kW			
				03C 105 209 AG	Z = 23/18			
				03C 115 225	56 Links/Bakla		MCK1200	MCK1240
				03C 109 507 AF				
	PASSAT Variant (3C5) 1.6 FSI	(08/05 → 06/08)		BLF	85 kW			
				03C 105 209 AC / BE	Z = 18/18			
				03C 115 230 C	54 Links/Bakla		MCK0580	MCK1240
				03C 109 507 J / AE				
	PASSAT Variant (3C5) 1.4 TSI	(05/07 → 11/10)		CAXA	90 kW			
	2007 → 2008			03C 105 209 AK	Z = 23/18; → 3C-8E110 000, → 3C-8P060 000			
				03C 115 225	56 Links/Bakla		MCK1200	MCK1240
				03C 109 507 AB/ AF				
				03C 105 209 AC / BE	Z = 18/18; 3C-8E110 001 →, 3C-8P060 001 →			
				03C 115 230 C	54 Links/Bakla		MCK0580	MCK1240
				03C 109 507 AE				
	2009 → 2010			03C 105 209 AC / BE	Z = 18/18; → 31/07/2008			
				03C 115 230 C	54 Links/Bakla		MCK0580	MCK1240
				03C 109 507 AE				
				03C 105 209 AQ	Z = 18/18; 01/08/2008 →			
				03C 115 225 A	54 Links/Bakla		MCK1210	MCK1240
				03C 109 507 AD				
	PASSAT Variant (3C5) 1.4 TSI EcoFuel	(01/09 → 11/10)		CDGA	110 kW			
				03C 105 209 AG	Z = 23/18			
				03C 115 225	56 Links/Bakla		MCK1200	MCK1240
				03C 109 507 AF				



				PARTS	OE		 COMPLETE KIT EASY KIT	
VOLKSWAGEN								
* PASSAT Variant (365) 1.4 TSI (08/10 → 12/14) CAXA 90 kW								
2010 → 2011				03C 105 209 AC / BE	Z 18/18; → 31/07/2008			
				03C 115 230 C	54 Links/Bakla	MCK0580	MCK1240	
				03C 109 507 AE				
				03C 105 209 AQ	Z = 18/18; 01/08/2008 →			
				03C 115 225 A	54 Links/Bakla	MCK120	MCK1240	
2011 → 2014				03C 109 507 AD				
				03C 105 209 AQ	Z = 18/18; 01/08/2008 →			
				03C 115 225 A	54 Links/Bakla	MCK1210	MCK1240	
				03C 109 507 AD				
				03C 105 209 AG	Z = 23/18			
				03C 115 225	56 Links/Bakla	MCK1200	MCK1240	
* PASSAT Variant (365) 1.4 TSI EcoFuel (08/10 → 12/14) CDGA 110 kW								
				03C 109 507 AF				
				03C 105 209 AG	Z = 23/18			
				03C 115 225	56 Links/Bakla	MCK1200	MCK1240	
* PASSAT Variant (365) 1.4 TSI MultiFuel (11/10 → 12/14) CKMA 118 kW								
				03C 109 507 AF				
				03C 105 209 AG	Z = 23/18			
				03C 115 225	56 Links/Bakla	MCK1200	MCK1240	
* PASSAT Variant (365) 1.4 TSI (11/12 → 12/14) CTHD 118 kW								
				03C 109 507 AF				
				03C 105 209 AG	Z = 23/18			
				03C 115 225	56 Links/Bakla	MCK1200	MCK1240	
POLO (9N_) 1.4 FSI (02/02 → 07/06) AXU 63 kW								
				03C 109 507 AE				
				03C 105 209 AC / BE	Z = 18/18			
				03C 115 230 C	54 Links/Bakla	MCK0580	MCK1240	
POLO (9N_) 1.6 16V (05/06 → 11/09) BTS 77 kW								
				03C 109 507 AE				
				03C 105 209 AC / BE	Z = 18/18			
				03C 115 230 C	54 Links/Bakla	MCK0580	MCK1240	
POLO (6R1, 6C1) 1.4 (6R1) (03/09 → 05/14) ; CLPA 63 kW								
				03C 109 507 AE				
				03C 105 209 AC / BE	Z = 18/18			
				03C 115 230 C	54 Links/Bakla	MCK0580	MCK1240	
POLO (6R1, 6C1) 1.4 GTI (05/10 →) CAVE; CTHE 132 kW								
				03C 109 507 AF				
				03C 105 209 AG	Z = 23/18			
				03C 115 225	56 Links/Bakla	MCK1200	MCK1240	
POLO (6R1, 6C1) 1.6 BiFuel (01/11 →) CNKA 60 kW								
				03C 109 507 AE				
				03C 105 209 AC / BE	Z = 18/18			
				03C 115 230 C	54 Links/Bakla	MCK0580	MCK1240	



				PARTS	OE			
							COMPLETE KIT	EASY KIT
VOLKSWAGEN								
SCIROCCO (137, 138) 1.4 TSI (08/08 → 11/17) CAXA; CMSB 90 kW								
2008 → 2015		03C 105 209 AQ	Z = 18/18				MCK1210	MCK1240
		03C 115 225 A	54 Links/Bakla					
		03C 109 507 AD						
2015 → 2018		03C 105 209 AQ	Z = 18/18; → 24/05/2015				MCK1210	MCK1240
		03C 115 225 A	54 Links/Bakla					
		03C 109 507 AD						
		03C 105 209 BD	Z = 19/18; 25/05/2015 →				MCK1220	MCK1250
		03C 115 225 A	54 Links/Bakla					
		03C 109 507 AD						
SCIROCCO (137, 138) 1.4 TSI (05/08 → 11/17) CAVD; CNWA; CTHD; CTKA 118 kW								
2008 → 2014		03C 105 209 AG	Z = 23/18; → 30/06/2008				MCK1200	MCK1240
		03C 115 225	56 Links/Bakla					
		03C 109 507 AF						
		03C 105 209 AR / AQ	Z = 18/18; 01/07/2008 →					
		03C 115 225 A	54 Links/Bakla					
2015 → 2018		03C 105 209 AQ	Z = 18/18; → 24/05/2015				MCK1210	MCK1240
		03C 115 225 A	54 Links/Bakla					
		03C 109 507 AD						
		03C 105 209 BD	Z = 19/18; 25/05/2015 →				MCK1220	MCK1250
		03C 115 225 A	54 Links/Bakla					
		03C 109 507 AD						
SHARAN (7N1, 7N2) 1.4 TSI (05/10 →) CAVA; CNWB; CTHA 110 kW								
2010 → 2016		03C 105 209 AR	Z = 18/18; → 24/05/2015				MCK1210	MCK1240
		03C 115 225 A	54 Links/Bakla					
		03C 109 507 AD						
		03C 105 209 BD	Z = 19/18; 25/05/2015 →					
		03C 115 225 A	54 Links/Bakla					
		03C 109 507 AD						
TIGUAN (5N_) 1.4 TSI (08/10 → 07/18) CAXA 90 kW								
2010 → 2011		03C 105 209 AQ	Z = 18/18				MCK1210	MCK1240
		03C 115 225 A	54 Links/Bakla					
		03C 109 507 AD						
2010 → 2011		03C 105 209 AR / AQ	Z = 18/18; → 24/05/2015				MCK1210	MCK1240
		03C 115 225 A	54 Links/Bakla					
		03C 109 507 AD						
		03C 105 209 BD	Z = 19/18; 25/05/2015 →				MCK1220	MCK1250
		03C 115 225 A	54 Links/Bakla					
		03C 109 507 AD						



			PARTS	OE			
						COMPLETE KIT	EASY KIT
VOLKSWAGEN							
TIGUAN (5N_) 1.4 TSI 4motion (09/07 → 07/18) BWK; CAVA; CTHA 110 kW							
2008 → 2011	AWD/4WD		03C 105 209 AG	Z = 23/18; → 02/11/2008	MCK1200	MCK1240	
			03C 115 225	56 Links/Bakla			
			03C 109 507 AF				
				03C 105 209 AR	Z = 18/18; 03/11/2008 →	MCK1210	MCK1240
				03C 115 225 A	54 Links/Bakla		
				03C 109 507 AD			
2012 → 2018			03C 105 209 AR / AQ	Z = 18/18; → 24/05/2015	MCK1210	MCK1240	
			03C 115 225 A	54 Links/Bakla			
			03C 109 507 AD				
				03C 105 209 BD	Z = 19/18; 25/05/2015 →	MCK1220	MCK1250
				03C 115 225 A	54 Links/Bakla		
				03C 109 507 AD			
TIGUAN (5N_) 1.4 TSI (05/08 → 07/18) CAVA, CTHA 110 kW							
2008 → 2011	AWD/4WD		03C 105 209 AG	Z = 23/18; → 02/11/2008 (4 motion)	MCK1200	MCK1240	
			03C 115 225	56 Links/Bakla			
			03C 109 507 AF				
	FWD			03C 105 209 AR	Z = 18/18; → 02/11/2008 (FWD)	MCK1210	MCK1240
				03C 115 225 A	54 Links/Bakla		
				03C 109 507 AD			
2012 → 2018			03C 105 209 AR / AQ	Z = 18/18; → 24/05/2015	MCK1210	MCK1240	
			03C 115 225 A	54 Links/Bakla			
			03C 109 507 AD				
				03C 105 209 BD	Z = 19/18; 25/05/2015 →	MCK1220	MCK1250
				03C 115 225 A	54 Links/Bakla		
				03C 109 507 AD			
TIGUAN (5N_) 1.4 TSI; 1.4 TSI 4motion (05/11 → 07/18) CAVD; CTHD 118 kW							
			03C 105 209 AR / AQ	Z = 18/18; → 24/05/2015	MCK1210	MCK1240	
			03C 115 225 A	54 Links/Bakla			
			03C 109 507 AD				
				03C 105 209 BD	Z = 19/18; 25/05/2015 →	MCK1220	MCK1250
				03C 115 225 A	54 Links/Bakla		
				03C 109 507 AD			
TOURAN (1T1, 1T2) 1.6 FSI (02/03 → 01/07) BAG; BLF; BLP 85 kW							
			03C 105 209 AC / BE	Z = 18/18	MCK0580	MCK1240	
			03C 115 230 C	56 Links/Bakla			
			03C 109 507 J / AE				
TOURAN (1T1, 1T2) 1.4 TSI (02/06 → 05/10) BMY; CAVC 103 kW							
2006 → 2008			03C 105 209 AF / AG	Z = 23/18	MCK1200	MCK1240	
			03C 115 225	56 Links/Bakla			
			03C 109 507 AF				
2009 → 2010			03C 105 209 AF / AG	Z = 23/18; → 1T-9-150 000	MCK1200	MCK1240	
			03C 115 225	56 Links/Bakla			
			03C 109 507 AF				
				03C 105 209 AR	Z = 18/18; 1T-9-150 001 →	MCK1210	MCK1240
				03C 115 225 A	54 Links/Bakla		
				03C 109 507 AD			



		PARTS	OE			COMPLETE KIT	EASY KIT
VOLKSWAGEN							
TOURAN (1T1, 1T2) 1.4 FSI (11/06 → 05/10) BLG; CAVB 125 kW							
2006 → 2008			03C 105 209 AF / AG	Z = 23/18	MCK1200	MCK1240	
			03C 115 225	56 Links/Bakla			
			03C 109 507 AF				
2009 → 2010	DSG		03C 105 209 AF / AG	Z = 23/18; → 1T-9-150 000	MCK1200	MCK1240	
			03C 115 225	56 Links/Bakla			
			03C 109 507 AF				
	M		03C 105 209 AR	Z = 18/18; 1T-9-150 001 →	MCK1210	MCK1240	
			03C 115 225 A	54 Links/Bakla			
			03C 109 507 AD				
TOURAN (1T1, 1T2) 1.4 TSI EcoFuel (05/09 → 05/10) CDGA 110 kW							
			03C 105 209 AG	Z = 23/18	MCK1200	MCK1240	
			03C 115 225	56 Links/Bakla			
			03C 109 507 AF				
TOURAN (1T3) 1.4 TSI (05/10 → 05/15) CAVC; CTHC 103 kW							
2010	DSG		03C 105 209 AF / AG	Z = 23/18; → 1T-9-150 000	MCK1200	MCK1240	
			03C 115 225	56 Links/Bakla			
			03C 109 507 AF				
	M		03C 105 209 AR	Z = 18/18; 1T-9-150 001 →	MCK1210	MCK1240	
			03C 115 225 A	54 Links/Bakla			
			03C 109 507 AD				
2011 → 2015			03C 105 209 AR	Z = 18/18	MCK1210	MCK1240	
			03C 115 225 A	54 Links/Bakla			
			3C 109 507 AD				
TOURAN (1T3) 1.4 TSI (05/10 → 05/15) CAVB; CTHB 125 kW							
2010	DSG		03C 105 209 AF / AG	Z = 23/18; → 1T-9-150 000	MCK1200	MCK1240	
			03C 115 225	56 Links/Bakla			
			03C 109 507 AF				
	M		03C 105 209 AR	Z = 18/18; 1T-9-150 001 →	MCK1210	MCK1240	
			03C 115 225 A	54 Links/Bakla			
			03C 109 507 AD				
2011 → 2015			03C 105 209 AR	Z = 18/18	MCK1210	MCK1240	
			03C 115 225 A	54 Links/Bakla			
			3C 109 507 AD				
TOURAN (1T3) 1.4 TSI EcoFuel (05/10 → 05/15) CDGA 110 kW							
			03C 105 209 AG	Z = 23/18	MCK1200	MCK1240	
			03C 115 225	56 Links/Bakla			
			03C 109 507 AF				



* Los vehículos **VOLKSWAGEN PASSAT (362) 1.4 TSI**, fabricados del 08/2010 al 12/2014 y **VOLKSWAGEN PASSAT Variant (365) 1.4 TSI**, fabricados desde 08/2010 hasta 12/2014, ensamblados entre el período de dos años 2010-2011 están entre el cambio de generación de la sexta (B6) a la séptima (B7).

Por esta razón, según los programas OE, la configuración piñón-cigüeñal instalada podría ser la de la generación anterior.

En estos vehículos, la elección del kit de cadena de distribución correcto está relacionada con la individualización del año y el mes de producción, lo cual no es una tarea fácil (puede diferir del año de registro escrito en el documento de registro del vehículo).

A continuación, una tabla de limitaciones adicionales a considerar:

08/2010 ile 12/2014 tarihleri arasında üretilen **VOLKSWAGEN PASSAT (362) 1.4 TSI** araçları ve 08/2010 ile 12/2014 tarihleri arasında üretilen ve iki yıllık dönem (2010-2011) içinde montajı yapılan **VOLKSWAGEN PASSAT Variant (365) 1.4 TSI** araçları altıncı nesilden (B6) yedinci nesle (B7) geçişi temsil etmektedir.

Bundan dolayı, OE programlarına göre, takılmış olan pinyon - krank mili konfigürasyonu bir önceki nesil olabilir.

Bu araçlarda, doğru triger zinciri kitinin seçilmesi, üretim yılı ve ayının doğru tespit edilmesiyle ilgilidir, ancak bu kolay değildir (bu tarih, araç tescil belgesinde yazılı tescil yılından farklı olabilir).

Aşağıda dikkate alınması gereken bir ek sınırlamalar tablosu verilmiştir:

			COMPONENTES PARÇALAR	OE		MAGNETI MARELLI PARTS & SERVICES	
						COMPLETE KIT	EASY KIT
→ 2009 (D>>-MJ 2009)			Piñón Pinyon dişlisi	03C 105 209 AC / BE	Z =18/18; → 31/07/2008	MCK0580	MCK1240
			Cigüeñal Krank mili	03C 105 101 BF/BM			
			Cojinete de empuje Baskı yatağı	06B 105 313 D			
			Piñón Pinyon dişlisi	03C 105 209 AQ	Z =18/18; 01/08/2008 →	MCK1210	MCK1240
			Cigüeñal Krank mili	03C 105 101 BF/BM			
			Cojinete de empuje Baskı yatağı	06B 105 313 D			
2010 (D-MJ 2010>>>) → 2012			Piñón Pinyon dişlisi	03C 105 209 AQ	Z = 18/18	MCK1210	MCK1240
			Cigüeñal Krank mili	03C 105 101 BF/BM			
			Cojinete de empuje Baskı yatağı	06B 105 313 D			
2012 →			Piñón Pinyon dişlisi	03C 105 209 AQ	Z = 18/18	MCK1210	MCK1240
			Cigüeñal Krank mili	03C 105 101 BM			
			Cojinete de empuje Baskı yatağı	06B 105 313 D			

Teniendo en cuenta todas estas diferentes variables, recomendamos verificar rigurosamente, a través de programas OE, los componentes instalados en el vehículo, para identificar el kit de reemplazo de la cadena de distribución correcto.

Tüm bu farklı değişkenleri göz önünde bulundurarak, doğru triger zinciri değiştirme kitini belirlemek için OE programları aracılığıyla araca takılı bileşenleri kontrol etmenizi tavsiye ederiz.



Años de producción del vehículo | Araç üretim yılları

**MAGNETI
MARELLI**

PARTS & SERVICES

FPM ve PTFE yağ keçeleri

DOĞRU TAKMA YÖNTEMİNE YÖNELİK TALİMATLAR VE ÖNLEMLER

Magneti Marelli Parts & Services zincir kitleri, biri **FPM** (florlu kauçuk) ve diğeri **PTFE** (Politetraflüoroetilen) olmak üzere iki tip yağ keçesi içermektedir.

İki yağ keçesi sadece imal edildikleri malzeme açısından değil, aynı zamanda doğru takma yöntemi ve ilgili önlemler bakımının da farklılık gösterir.

FPM (florlu kauçuk) yağ keçeleri

Özellikleri

- Bu yağ keçeleri "geleneksel" tip olarak kabul edilir.
- Yağ ile temas halindeki iç ortam ile dış ortam arasında fiziksel bir bariyer oluştururlar.
- İç yağ keçesi dudağının tüm çevresine basınç uygulayan ve böylece sızdırmazlığı daha iyi hale getiren metal bir yayları vardır.

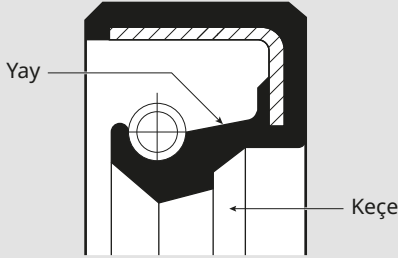

Takma talimatları

- Keçe verilerini (boyut ve dönme yönü) ve değiştirilecek yağ keçesi malzemesinin tipini kontrol edin.
- Yağ keçesine temas eden tüm metal yüzeylerdeki kir ve kalıntıları temizleyin.
- **Yağ keçesinin veya keçe muhafazasının dış yüzeyine gres veya yağ sürmeyin.** Bu yüzeyler kirlenirse, keçe takıldığında dış sızdırmazlık olumsuz etkilendir.
- **Yağ keçesinin iç sızdırmazlık dudağına ve sadece milin kayma yüzeyine gres sürün.**
- Uygun aletler kullanarak keçeyi yerine oturtun. Keçe verilerini gösteren taraf dışarı doğru bakmalıdır.



Yağ keçesi hemen etkili olmaya başlar ve motor 10 dakika sonra çalıştırılabilir.

PTFE (politetraflüoroetilen) yağ keçesi

Özellikleri

Dahili bir metal yayı olmayan bu yağ keçelerinin aşağıdaki özellikleri vardır:

- Metal ile temas halinde olan geniş sızdırmazlık yüzeyi, daha iyi sızdırmazlık sağlar.
- Yüksek dönme hızlarında bile gerilime karşı yüksek mekanik direnç.
- Katkı maddeli yağlara karşı geliştirilmiş kimyasal direnç.
- Yüksek sıcaklıklara karşı yüksek direnç.
- Sürtünmeden kaynaklı kaçaklarda önemli azalma.

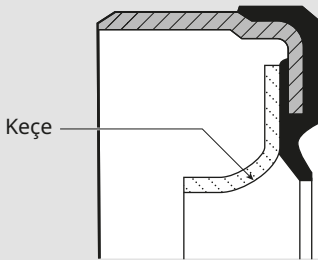

Takma talimatları



Bu yağ keçeleri FPM tipi "geleneksel" yağ keçelerinden farklı şekilde takılır; iç dudak, keçenin şeklini koruyan ve mile mükemmel bir şekilde yapışmasını sağlayan plastik bir manşonla korunmaktadır. **Manşon yalnızca yağ keçesi takıldığı zaman çıkarılmalıdır.**

- Yağ keçesini takmak için özel aletler gereklidir. **Keçenin iç dudağına hiçbir şekilde zarar vermeyin.**
- PTFE yağ keçesi, gres ve/veya yağ kullanılmadan kuru şekilde takılmalıdır. **Bu tip yağ keçesi asla yağlanmamalıdır.**
- Keçe verilerini (boyut ve dönme yönü) ve değiştirilecek yağ keçesi malzemesinin tipini kontrol edin.
- Yağ keçesine temas eden tüm metal yüzeylerdeki kir ve kalıntıları temizleyin.
- Milin yüzeyini kontrol edin ve çizik veya başka hasarlar olmadığından emin olun Düzensizlikler giderilmelidir.
- Manşonun oluklu ucunu milin üzerine yerleştirin. Yağ keçesini, manşon boyunca kaydırarak yuvasına yerleştirin. Yağ keçesi yuvasına yerleştirildikten sonra manşonu çıkartın.



PTFE yağ keçesi hemen etkili olmaz. Keçenin mile alışması ve tam sızdırmazlık sağlaması için, keçeyi taktıktan sonra motoru çalıştırmadan dört saate kadar bekleyin.

Bu yayında yer alan talimatlar, tavsiyeler ve bilgiler büyük bir titizlikle hazırlanmıştır.

Marelli Aftermarket Italy S.p.A., bağlı şirketleri/yan kuruluşları adına ve namına, burada yer alan bilgilerin yanlış yorumlanmasından kaynaklanan hasarlardan dolayı herhangi bir sorumluluk kabul etmez.