

x 2

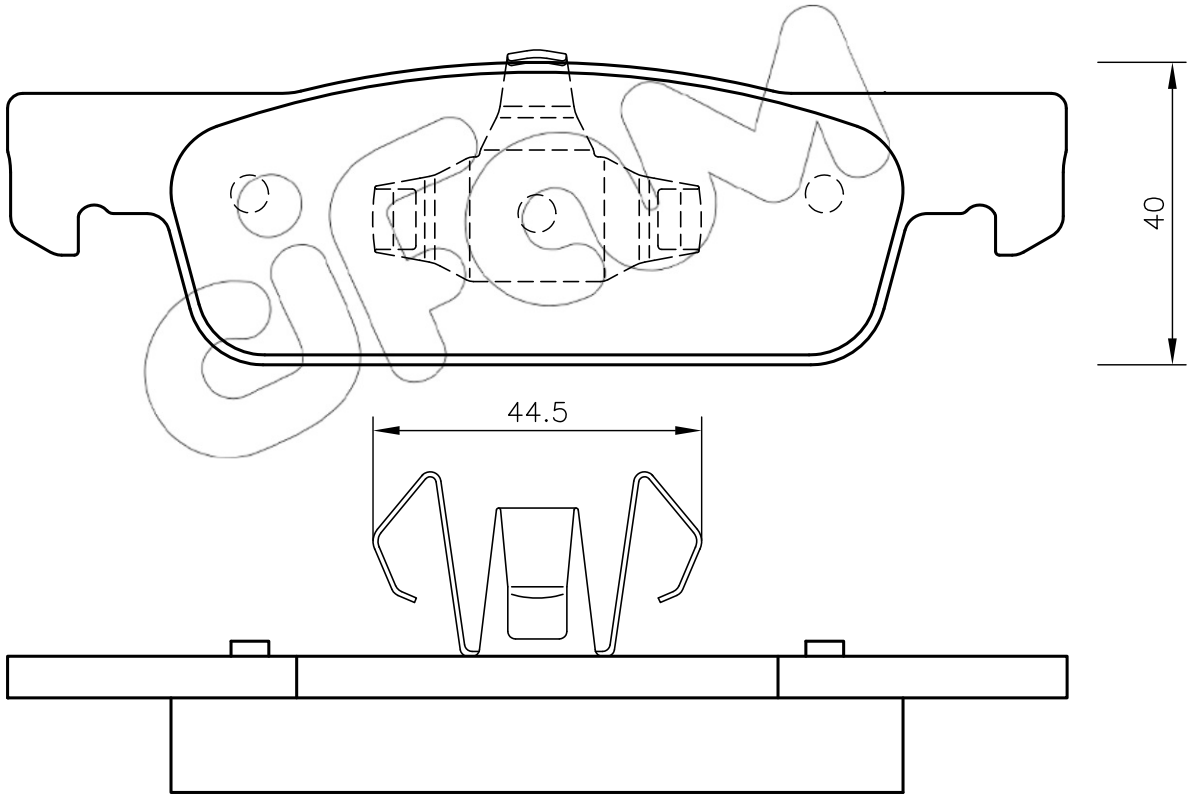

x 2

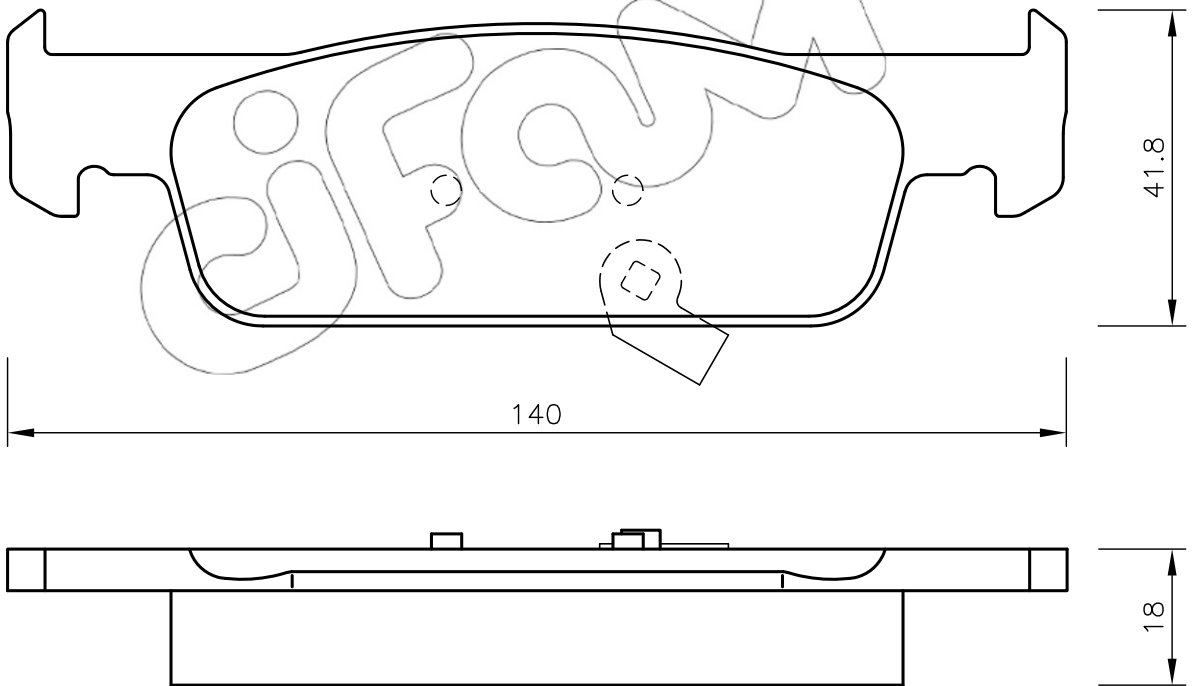

18